

JEAN-LOUIS LODAY

Volume 301

Grundlehren
der mathematischen
Wissenschaften

A Series of
Comprehensive Studies
in Mathematics

CYCLIC HOMOLOGY

SECOND EDITION



Springer

Grundlehren der mathematischen Wissenschaften 301

A Series of Comprehensive Studies in Mathematics

Editors

S.S. Chern B. Eckmann P. de la Harpe
H. Hironaka F. Hirzebruch N. Hitchin
L. Hörmander M.-A. Knus A. Kupiainen
J. Lannes G. Lebeau M. Ratner D. Serre
Ya.G. Sinai N. J. A. Sloane J. Tits
M. Waldschmidt S. Watanabe

Managing Editors

M. Berger J. Coates S.R.S. Varadhan

Springer-Verlag Berlin Heidelberg GmbH

Jean-Louis Loday

Cyclic Homology

Second Edition

With 24 Figures



Springer

Jean-Louis Loday

Institut de Recherche Mathématique Avancée
Centre National de la Recherche Scientifique
7, rue René Descartes
F-67084 Strasbourg, France

Library of Congress Cataloging-in-Publication Data

Loday, Jean-Louis.

Cyclic homology / Jean-Louis Loday. - 2nd ed.

p. cm. - (Grundlehren der mathematischen Wissenschaften; 301)

Includes bibliographical references and index.

ISBN 978-3-642-08316-7

ISBN 978-3-662-11389-9 (eBook)

DOI 10.1007/978-3-662-11389-9

1. Homology theory. I. Title. II. Series.

QA612.3.L63 1998 512'.55-dc21 97-22418 CIP

Mathematics Subject Classification (1991):

Primary: 14Fxx, 16E40, 17B56, 18F25, 18Gxx, 19-xx, 46Lxx,
55-xx

Secondary: 05A19, 16E30, 16R30, 16Wxx, 17D99, 20B30, 57R20,
58B30

ISSN 0072-7830

ISBN 978-3-642-08316-7

This work is subject to copyright. All rights are reserved, whether the whole or part of the material is concerned, specifically the rights of translation, reprinting, reuse of illustrations, recitation, broadcasting, reproduction on microfilm or in any other way, and storage in data banks. Duplication of this publication or parts thereof is permitted only under the provisions of the German Copyright Law of September 9, 1965, in its current version, and permission for use must always be obtained from Springer-Verlag Berlin Heidelberg GmbH.

Violations are liable for prosecution under the German Copyright Law.

© Springer-Verlag Berlin Heidelberg 1992, 1998

Originally published by Springer-Verlag Berlin Heidelberg New York in 1998

Cover design: MetaDesign plus GmbH, Berlin

Data conversion: Satztechnik K. Steingraeber, Heidelberg, Germany, using a Springer T_EX macro-package

SPIN: 11768654 41/3111-5 4 3 2 Printed on acid-free paper

...

Une mathématique bleue
Dans une mer jamais étale
D'où nous remonte peu à peu
Cette mémoire des étoiles

...

Léo Ferré

À Éliane

Preface to the Second Edition

Apart from correction of misprints, inaccuracies and errors, the main difference between the second edition and the first is the addition of a new chapter on *Mac Lane (co)homology*, written jointly with Teimuraz Pirashvili. It is related to Hochschild homology, to algebraic K -theory and cohomology of small categories as treated in the previous chapters (see the introduction to Chapter 13). Appendix C has been modified accordingly.

The first list of references was reasonably up to date for papers dealing with cyclic homology until 1992. It contains all the references mentioned in Chapters 1 to 12 and in the appendices. Chapter 13 has its own list of references. Since the publication of the first edition numerous results on the cyclic theory have appeared, namely about the periodic theory, and also about topological cyclic homology. For the convenience of the reader we give a second list of references concerning the cyclic theory for the period 1992-96.

It is a pleasure to thank here all the colleagues who helped me to improve this second edition, namely C. Allday, C.-F. Bödigheimer, J. Browkin, B. Dayton, I. Emmanouil, V. Franjou, A. Frabetti, J. Franke, F. Goichot, V. Gnedbaye, J.A. Guccione, J.J. Guccione, P. Julg, W. van der Kallen, M. Karoubi, C. Kassel, B. Keller, M. Khalkhali, J. Lodder, J. Majadas, J. McCleary, M. Ronco, G. van der Sandt.

It is a pleasure to warmly thank Teimuraz Pirashvili for numerous enlightening conversations and for his kind collaboration on Chapter 13.

At 48°35'N and 7°48'E, January 21st, 1997.

Préface

Il y a maintenant 10 ans que l'homologie cyclique a pris son essor et le rythme de parution des publications à son sujet confirme son importance. Durant ce laps de temps l'effet de sédimentation a pu opérer et il devenait possible, sinon nécessaire, de disposer d'un ouvrage de référence sur le sujet.

Je n'ai pu écrire ce livre que grâce aux enseignements et à l'aide de nombreux collègues, que je voudrais remercier ici. Les cours de topologie algébrique d'Henri Cartan, qui resteront certainement dans la mémoire de ses auditeurs, ont constitué mon initiation et il est difficile d'en être digne. Max Karoubi m'a introduit à la K -théorie, topologique tout d'abord, puis algébrique ensuite, et son enseignement n'a pas peu contribué à ma formation. Dan Quillen a été constamment présent tout au long de ces années. Au début ce fut par ses écrits (cobordisme et groupes formels, homotopie rationnelle), puis par ses exposés (K -théorie algébrique) et, plus récemment, par une collaboration qui est à l'origine de ce livre. Les conversations et discussions avec Alain Connes furent toujours stimulantes et exaltantes. Ses encouragements et son aide furent pour moi un soutien constant. Je voudrais aussi remercier Zbigniew Fiedorowicz, Claudio Procesi et Ronnie Brown pour leur collaboration efficace et amicale. Remerciements aussi à Keith Dennis pour m'avoir donné l'opportunité de faire un cours sur l'homologie cyclique à Cornell University au tout début de la rédaction et à Jean-Luc Brylinski pour un semestre fructueux passé à Penn State University. Ce livre doit aussi beaucoup à de nombreux autres collègues, soit pour des discussions, soit pour des commentaires pertinents, en particulier à L. Avramov, P. Blanc, J.-L. Cathelineau, C. Cuvier, S. Chase, P. Gaucher, F. Goichot, P. Julg, W. van der Kallen, C. Kassel, P. Ion, J. Lodder, R. MacCarthy, A. Solotar, T. Pirashvili, C. Weibel et le rapporteur. Mamuka Jiblaze a relu entièrement le manuscrit durant la phase finale et je lui en sais gré.

Je voudrais aussi mentionner tout particulièrement Maria Ronco pour m'avoir toujours écouté avec attention, pour avoir lu plusieurs versions de ce livre et pour avoir corrigé de nombreuses imprécisions. Enfin et surtout je terminerai en remerciant chaleureusement Daniel Guin pour le nombre incalculable d'heures que nous avons passé ensemble devant un tableau noir et dont je garde le meilleur souvenir.

Par 48° 35'N et 7° 48'E, le 12 janvier 1992.

Contents

Introduction	XV
Notation and Terminology	XIX
Chapter 1. Hochschild Homology	1
1.0 Chain Complexes	2
1.1 Hochschild Homology	8
1.2 The Trace Map and Morita Invariance	16
1.3 Derivations, Differential Forms	23
1.4 Nonunital Algebras and Excision	29
1.5 Hochschild Cohomology, Cotrace, Duality	37
1.6 Simplicial Modules	44
Bibliographical Comments on Chapter 1	48
Chapter 2. Cyclic Homology of Algebras	51
2.1 Definition of Cyclic Homology	53
2.2 Connes' Exact Sequence, Morita Invariance, Excision	61
2.3 Differential Forms, de Rham Cohomology	68
2.4 Cyclic Cohomology	72
2.5 Cyclic Modules	75
2.6 Non-commutative Differential Forms	83
Bibliographical Comments on Chapter 2	88
Chapter 3. Smooth Algebras and Other Examples	89
3.1 Tensor Algebra	90
3.2 Symmetric Algebras	94
3.3 Universal Enveloping Algebras of Lie Algebras	97
3.4 Smooth Algebras	101
3.5 André-Quillen Homology	107
3.6 Deligne Cohomology	112
Bibliographical Comments on Chapter 3	114

Chapter 4. Operations on Hochschild and Cyclic Homology	115
4.1 Conjugation and Derivation	116
4.2 Shuffle Product in Hochschild Homology	123
4.3 Cyclic Shuffles and Künneth Sequence for HC	127
4.4 Product, Coproduct in Cyclic Homology	133
4.5 λ -Decomposition for Hochschild Homology	139
4.6 λ -Decomposition for Cyclic Homology	149
Bibliographical Comments on Chapter 4	155
Chapter 5. Variations on Cyclic Homology	157
5.1 The Periodic and Negative Theories	158
5.2 Dihedral and Quaternionic Homology	167
5.3 Differential Graded Algebras	175
5.4 Commutative Differential Graded Algebras	182
5.5 Bivariant Cyclic Cohomology	190
5.6 Topological Algebras, Entire Cyclic Cohomology	195
Bibliographical Comments on Chapter 5	199
Chapter 6. The Cyclic Category, Tor and Ext Interpretation	201
6.1 Connes Cyclic Category ΔC and the Category ΔS	202
6.2 Tor and Ext Interpretation of HH and HC	211
6.3 Crossed Simplicial Groups	214
6.4 The Category of Finite Sets and the λ -Decomposition	220
Bibliographical Comments on Chapter 6	225
Chapter 7. Cyclic Spaces and S^1-Equivariant Homology	227
7.1 Cyclic Sets and Cyclic Spaces	228
7.2 Cyclic Homology and S^1 -Equivariant Homology	234
7.3 Examples of Cyclic Sets and the Free Loop Space	241
7.4 Hochschild Homology and Cyclic Homology of Group Algebras	250
Bibliographical Comments on Chapter 7	256
Chapter 8. Chern Character	257
8.1 The Classical Chern Character à la Chern-Weil	258
8.2 The Grothendieck Group K_0	261
8.3 The Chern Character from K_0 to Cyclic Homology	264
8.4 The Dennis Trace Map and the Generalized Chern Character	269
8.5 The Bass Trace Conjecture and the Idempotent Conjecture	277
Bibliographical Comments on Chapter 8	279

Chapter 9. Classical Invariant Theory	281
9.1 The Fundamental Theorems of Invariant Theory	282
9.2 Coinvariant Theory and the Trace Map	284
9.3 Cayley-Hamilton and Amitsur-Levitzki Formulas	287
9.4 Proofs of the Fundamental Theorems	291
9.5 Invariant Theory for the Orthogonal and Symplectic Groups ...	293
Bibliographical Comments on Chapter 9	297
Chapter 10. Homology of Lie Algebras of Matrices	299
10.1 Homology of Lie Algebras	301
10.2 Homology of the Lie Algebra $gl(A)$	306
10.3 Stability and First Obstruction to Stability	315
10.4 Homology with Coefficients in the Adjoint Representation	320
10.5 The Symplectic and Orthogonal Cases	323
10.6 Non-commutative Homology (or Leibniz Homology) of the Lie Algebra of Matrices	326
Bibliographical Comments on Chapter 10	340
Chapter 11. Algebraic K-Theory	341
11.1 The Bass-Whitehead Group K_1 and the Milnor Group K_2	342
11.2 Higher Algebraic K -Theory	349
11.3 Algebraic K -Theory and Cyclic Homology of Nilpotent Ideals ..	361
11.4 Absolute and Relative Chern Characters	371
11.5 Secondary Characteristic Classes	375
Bibliographical Comments on Chapter 11	379
Chapter 12. Non-commutative Differential Geometry	381
12.1 Foliations and the Godbillon-Vey Invariant	382
12.2 Fredholm Modules and Index Theorems	385
12.3 Novikov Conjecture on Higher Signatures	390
12.4 The K -Theoretic Analogue of the Novikov Conjecture	395
Chapter 13. Mac Lane (co)homology	399
by Jean-Louis Loday and Teimuraz Pirashvili	
13.1 (Co)homology with Coefficients in Non-additive Bimodules	401
13.2 Mac Lane (co)homology	408
13.3 Stable K -theory and Mac Lane homology	417
13.4 Calculations	428
Bibliographical Comments on Chapter 13	442
References of Chapter 13	443

Appendices

A. Hopf Algebras	447
B. Simplicial	453
C. Homology of Discrete Groups and Small Categories	461
D. Spectral Sequences	469
E. Smooth Algebras	473

References	485
-------------------------	-----

References 1992–1996	499
-----------------------------------	-----

Symbols	509
----------------------	-----

Index	511
--------------------	-----

Introduction

Cyclic homology appeared almost simultaneously from several directions. In one, Alain Connes [C] developed cyclic homology as a non-commutative variant of the de Rham cohomology, in order to interpret index theorems for non-commutative Banach algebras, via a generalization of the Chern character. In another, cyclic homology was shown to be the primitive part of the Lie algebra homology of matrices by Boris Tsygan [1983], and by Dan Quillen and myself [1983, LQ]. This relationship shows that cyclic homology can be considered as a Lie analogue of algebraic K -theory, and, in fact, I met it for the first time through the cyclic property of some higher symbols in algebraic K -theory (cf. [Loday [1981]). There is still another framework where cyclic homology plays an important rôle: the homology of S^1 -spaces, which provides the connection between index theorems and algebraic K -theory. We will see that cyclic homology theory illuminates a great many interactions between algebra, topology, geometry, and analysis.

The contents of the book can be divided into three main topics:

- cyclic homology of algebras (Chaps. 1–5), which essentially deals with homological algebra,
- cyclic sets and S^1 -spaces (Chaps. 6–8), which uses the simplicial technique and some algebraic topology,
- Lie algebras and algebraic K -theory (Chaps. 9–11), which is about the relationship with the homology of matrices under different guises.

The last chapter (Chap. 12), which contains no proof, is essentially an opening towards Connes' work and recent results on the Novikov conjectures.

The cyclic homology of an algebra A consists of a family of abelian groups $HC_n(A)$, $n \geq 0$, which are, in characteristic zero, the homology groups of the quotient of the Hochschild complex by the action of the finite cyclic groups. This is the reason for the term “cyclic”. The notation HC was for “Homologie de Connes”, but soon became “Homologie Cyclique”. This very first definition of Connes was slightly modified later on, so as to give a good theory in a characteristic-free context. In any case, the basic ingredient is the Hochschild complex, so the first chapter is about Hochschild homology, whose groups are denoted $HH_n(A)$, $n \geq 0$. Chapter 2 contains several definitions of cyclic homology, together with the basic properties of the functors HC_n . The most important one is Connes periodicity exact sequence,

$$\dots \rightarrow HH_n(A) \rightarrow HC_n(A) \rightarrow HC_{n-2}(A) \rightarrow HH_{n-1}(A) \rightarrow \dots$$

In Chap. 3 we perform some computation for tensor algebras, symmetric algebras, universal enveloping algebras and smooth algebras. We emphasize the relationship with the de Rham cohomology (in the commutative case). For smooth algebras, in characteristic zero, it takes the form of an isomorphism

$$HC_n(A) \cong \Omega_{A|k}^n / d\Omega_{A|k}^{n-1} \oplus H_{DR}^{n-2}(A) \oplus H_{DR}^{n-4}(A) \oplus \dots$$

Chapter 4 is about the operations on cyclic homology: conjugation, derivation, product, coproduct, and λ -operations. These latter operations bring in some very interesting idempotents lying in the group algebra of the symmetric group, called the *Eulerian idempotents*. They are related to combinatorics (Eulerian numbers) and to the Campbell-Hausdorff formula. They permit us to show the existence of a λ -decomposition of the cyclic homology of a commutative algebra,

$$HC_n(A) = HC_n^{(1)}(A) \oplus \dots \oplus HC_n^{(n)}(A).$$

In both Chaps. 3 and 4 we give explicit isomorphisms and explicit homotopies (instead of using the acyclic model method) so as to give the possibility to extend these proofs to other settings (entire cyclic cohomology for instance).

In Chap. 5, important variations of cyclic homology are studied. The “negative cyclic homology”, introduced by J.D.S. Jones and T. Goodwillie, is the right range for the Chern-Connes character. The “periodic cyclic theory” is close to the de Rham theory for commutative algebras. The “dihedral theory” comes in when dealing with skew-symmetric and symplectic matrices. We also study cyclic homology of differential graded algebras, since it is an efficient tool for computation.

The second part starts, in Chap. 6, with a detailed analysis of the relationship between the finite cyclic groups and the simplicial category Δ of non-decreasing maps on finite sets. It gives rise to the cyclic category ΔC of Connes. Other similar situations are studied for other families of groups: the dihedral groups, the symmetric groups, the hyperoctahedral groups, and the braid groups. The cyclic category permits us to interpret the cyclic groups as derived functors and to construct cyclic sets and cyclic spaces. The main point (Chap. 7) is that their geometric realizations are S^1 -spaces and that, for any cyclic set X , there is an isomorphism

$$HC_*(k[X]) \cong H_*^{S^1}(|X|, k).$$

An important example, which arises naturally by this procedure, is the free loop space of a topological space (equivalent to Witten’s way of handling the free loop space of a manifold). We also include in this chapter the computation of the cyclic homology of a group algebra, which is going to play an important rôle in the construction of the Chern-Connes character. The study of this character is carried out in Chap. 8. The classical Chern character is a

morphism from K -theory to de Rham cohomology. In the non-commutative framework the range space is cyclic homology; in fact negative cyclic homology is best. The construction of this Chern character

$$ch^- : K_n(A) \rightarrow HC_n^-(A),$$

was the main motivation of Connes in building the cyclic theory. This chapter ends up with an application to the idempotent conjecture.

The last part is essentially devoted to the relationship of the cyclic theory with homology of matrices, either (under their additive structure) Lie algebra homology, or (under their multiplicative structure) homology of the general linear group or more precisely algebraic K -theory. Chapter 9 is an account of the classical invariant theory used as a tool in Chap. 10. The main result of Chap. 10 claims that the homology of the Lie algebra of matrices is computable, in characteristic zero, in terms of cyclic homology (Loday-Quillen-Tsygan theorem),

$$H_*(gl(A)) \cong \Lambda(HC_{*-1}(A)).$$

This result is supplemented with some partial results on the computation of $H_*(gl_r(A))$, r fixed. Conjectures (cf. 10.3.9) for the general case are proposed in terms of the λ -decomposition of $HC_*(A)$. Some variations are briefly treated: adjoint representation as coefficients, skew-symmetric and symplectic algebras. The last section introduces a completely new variant of Lie homology, called “non-commutative Lie algebra homology” and denoted $HL_n(\mathfrak{g})$, $n \geq 0$. It consists in replacing, in the Chevalley-Eilenberg complex of the Lie algebra \mathfrak{g} (used to define $H_n(\mathfrak{g})$), the exterior module $\Lambda\mathfrak{g}$ by the tensor module $T\mathfrak{g}$. The tricky point was to find the correct differential in this framework. Then, the analogue of the L - Q - T theorem mentioned above is

$$HL_*(gl(A)) \cong T(HH_{*-1}(A)).$$

Important generalizations of this non-commutative theory, with Lie algebras replaced by groups or spaces, are to be expected.

Chapter 11 is devoted to algebraic K -theory and its relationship to cyclic homology. The first two sections form a short introduction to algebraic K -theory of rings. Then we study in detail the relationship between the K -theory of a nilpotent ideal I and the corresponding cyclic homology. The aim is to prove the following isomorphism, due to T. Goodwillie,

$$K_n(A, I) \otimes \mathbb{Q} \cong HC_{n-1}(A, I) \otimes \mathbb{Q}.$$

The rest of the chapter is a continuation of the chapter on the Chern character, with a succinct account of secondary characteristic classes as done by M. Karoubi.

We end this book with a chapter on “Non-Commutative Differential Geometry”. The aim is to give an overview of some applications of the cyclic

theory to the Godbillon-Vey invariant, to the index theorem for Fredholm modules, and to the Novikov conjecture on higher signatures and its K -theoretic analogue. This chapter is expository and without any proof. All these subjects are under active current research.

In this second edition we add a chapter on Mac Lane (co)homology which is a variant of Hochschild (co)homology suitable to deal with when one works with rings instead of k -algebras (to classify extensions for instance). On the other hand algebraic K -theory gives rise to a “more additive” theory called *stable K -theory*. It turns out that these two theories are isomorphic. The main tool for this comparison is a third theory constructed from derived functors over the category of polynomial functors (non-additive bimodules). This is the subject of Chapter 13 which is a transition from the content of the first 12 chapters to topological Hochschild homology (*THH*) and topological cyclic homology (*TC*).

Among the five appendices the first four are recapitulations of notions, techniques and results used throughout the book. The last one, written by María Ofelia Ronco, is a survey, with proofs, on “smooth algebras”.

Conceived as a comprehensive study of the cyclic homology theory, this book requires some acquaintance with homological algebra and for some chapters, some familiarity with the basic techniques of algebraic topology. However it is conceivable to give a graduate course in homological algebra from the first chapters or another one on the chapters on invariant theory and Lie algebras. We have tried to make the statements and the proofs as self-contained as possible, though at some particular points we refer to Cartan-Eilenberg [CE] or Mac Lane [ML] for details. Beginning with chapter one is not the only way to read this book. If one is only interested in the Lie algebra results, then one can go directly to Chap. 10 (or Chap. 9, if invariant theory is not at one’s disposal). If one is interested in cyclic sets and S^1 -spaces, then one can begin with Sects. 6.1 and 6.2, and then go directly to Chap. 7. For the construction of the Chern character, read Sects. 1.1, 2.1, 5.1, and then Chap. 8. More itineraries are possible, corresponding to other interests.

Most of the results are already in the literature, in research articles, though several proofs are original. The bibliographical comments at the end of each chapter try to give appropriate credit and information for further reading.

Notation and Terminology

The standard language and notation of set theory, homological algebra and algebraic topology is used throughout. For instance \mathbb{Z} is the ring of integers, \mathbb{Q} , \mathbb{R} , \mathbb{C} , are the fields of rational, real and complex numbers respectively. The arrow \hookrightarrow (resp. \twoheadrightarrow) stands for a monomorphism (resp. an epimorphism), that is an injective (resp. surjective) map if in the category of sets.

Categories are denoted by boldface characters : **(Sets)** for the category of sets, **(Spaces)** for the category of compactly generated spaces and continuous maps, **(k -Mod)** for the category of k -modules and k -linear maps, etc.

A notation like $\pi_n(X) := [S^n, X]$ indicates a definition of the left-hand term.

Throughout the book k denotes a commutative ring, which sometimes satisfies some conditions like k contains \mathbb{Q} or k is a field. Every module M over k is supposed to be symmetric and unital: $\lambda m = m\lambda$, $1m = m$. An algebra A over k need not have a unit. If it has a unit, then it is called *unital*. The term “ k -linear map” is often abbreviated into “map”. Tensor products are taken over k unless otherwise stated, and so $\otimes = \otimes_k$.

The automorphism group of the set $\{1, 2, \dots, n\}$ is called a *permutation group* and denoted by S_n . It is sometimes helpful to make it act on the set $\{0, 1, \dots, n - 1\}$ instead. The sign of a permutation $\sigma \in S_n$ is denoted by $\text{sgn}(\sigma) \in \{\pm 1\}$.

For any discrete group G the group algebra $k[G]$ is the free module over k with basis G . On elements of G the product is given by the grouplaw. For other elements it is extended by linearity.

More notation is introduced in Sect. 1.0 and in the appendices A, B and C.

The symbol \square indicates the end or the absence of a proof.

Standing assumption valid for the whole chapter or section are indicated in the introduction of the relevant chapter or section.

The exercises are, most of the time, interesting results that we want to mention, but do not prove. Hints or, more often, bibliographical references are given in brackets.

Chapter 1. Hochschild Homology

Since cyclic homology is, in a certain sense, a variant of Hochschild homology we begin with a chapter on this theory. Most of the material presented here is classical and has been known for more than thirty years (except Sect. 1.4). However our presentation is adapted to fit in with the subsequent chapters. One way to think of the relevance of Hochschild homology is to view it as a generalization of the modules of differential forms to non-commutative algebras. In fact, as will be proved in Chap. 3, it is only for smooth algebras that these two theories agree.

Hochschild homology of the k -algebra A (k being a commutative ring) with coefficients in an A -bimodule M consists of a family of k -modules $H_n(A, M)$ defined for any $n \geq 0$. The case $M = A$ is of particular interest for us since $H_n(A, A)$ is closely related to cyclic homology and we denote it by $HH_n(A)$. There are several possible definitions of Hochschild homology. Though one of the most popular is through derived functors (in fact Tor-functors) we emphasize the original definition of Hochschild out of which cyclic homology is constructed.

The main general properties of HH_n are proved in view of their counterpart in cyclic homology. Computations will be found in Chap. 3 and also in Sect. 7.4 for group algebras.

Section 1.0 on chain complexes consists of a list of background results in homological algebra (mainly without proofs). It fixes the main notation and notions used throughout the book.

Section 1.1 defines Hochschild homology via the Hochschild complex, shows its equivalence with the Tor-definition (via the bar complex) and sets up the normalized Hochschild complex which is often more convenient to use.

Section 1.2 is essentially devoted to the computation of Hochschild homology of matrix algebras. The main result asserts that the generalized trace map induces an isomorphism. This Morita invariance is in fact proved in full generality.

Section 1.3 emphasizes the relationship between Hochschild homology, the module of derivations and the module of differential forms $\Omega_{A|k}^*$ (in the commutative case). The so-called antisymmetrization map from $\Omega_{A|k}^*$ to $HH_*(A)$ is of great importance for future computation. It shows that Hoch-

schild homology is a good substitute for differential forms when the algebra A is non-commutative.

Section 1.4 is slightly technical and can be skipped in a first reading. It studies the case of nonunital algebras. Most of the results of this section are due to M. Wodzicki. The cyclic operator, which is going to play a fundamental role in cyclic homology (next chapter), crops up upon the attempt at defining HH_* for nonunital algebras. The notion of H-unitality (nonunital algebras having the same properties as unital algebras as far as HH_* is concerned) plays a significant role in the applications (namely to excision in algebraic K -theory).

Section 1.5 gives an account of Hochschild cohomology and its dual relationship with the homology theory.

Finally, Sect. 1.6 on simplicial modules can be thought of as an axiomatization of the preceding results, which will prove helpful in the sequel. It serves as an introduction to the section on cyclic modules and cyclic sets.

1.0 Chain Complexes

This section is a quick summary on chain complexes and bicomplexes. Its main purpose is to fix notation. Proofs and subsequent results can be found in any text book on homological algebra, for instance Cartan-Eilenberg [CE], Mac Lane [ML], Bourbaki [1980].

1.0.1 Definition. A chain complex C_* of k -modules, or simply a complex C , is a sequence of k -module homomorphisms

$$(C_*) \quad \dots \xrightarrow{d} C_n \xrightarrow{d} C_{n-1} \xrightarrow{d} \dots \xrightarrow{d} C_1 \xrightarrow{d} C_0 \xrightarrow{d} C_{-1} \xrightarrow{d} \dots$$

such that $d \circ d = 0$. We adopt the classical convention of not putting any index on the boundary map d , which is sometimes called the differential map.

We are mainly interested in non-negative chain complexes, that is we take $C_{-n} = 0$ if $n > 0$. So, in general, by “complex” we mean a non-negatively graded chain complex over k . An element $x \in C_n$ is a chain of degree (or of dimension) n . We adopt the notation $|x| = n$.

The cycles are the elements of $Z_n = \text{Ker}(d : C_n \rightarrow C_{n-1})$. The boundaries are the elements of $B_n = \text{Im}(d : C_{n+1} \rightarrow C_n)$. The relation $d \circ d = 0$ implies $B_n \subset Z_n$. The homology groups (which are in fact k -modules) are defined by $H_n(C_*, d) = Z_n/B_n$ and are also denoted $H_n(C)$. The homology class of the cycle x is denoted by $[x]$ or simply by x .

1.0.2 Morphisms of Complexes. A map of complexes $f : C \rightarrow C'$ is a collection of linear maps $f_n : C_n \rightarrow C'_n$ such that the following diagram is commutative for any n

$$\begin{array}{ccc}
 C_n & \xrightarrow{d} & C_{n-1} \\
 f_n \downarrow & & \downarrow f_{n-1} \\
 C'_n & \xrightarrow{d} & C'_{n-1}
 \end{array}$$

It obviously induces a map $f_* : H_n(C) \rightarrow H_n(C')$ (sometimes also denoted simply by f). The map of complexes f is called a *quasi-isomorphism* (or *chain equivalence*) if f_* is an isomorphism for all n .

Two maps of complexes f and $g: C \rightarrow C'$ are *chain homotopic* (or simply *homotopic*) if there exist maps $h = h_n : C_n \rightarrow C'_{n+1}$ for all n such that

$$dh + hd = f - g$$

(by this we mean that for all n the morphisms $dh_n + h_{n-1}d$ and $f_n - g_n: C_n \rightarrow C'_n$ are equal). The map h is called a *homotopy* from f to g .

A map of degree r is a family of maps $f_n: C_n \rightarrow C'_{n+r}$ which commute with the boundary maps.

1.0.3 Lemma. *If f and g are chain homotopic, then $f_* = g_* : H_*(C) \rightarrow H_*(C')$.*

Proof. Let x be a cycle of C_* , then $f(x) - g(x) = (dh + hd)(x) = dh(x)$ because $d(x) = 0$. Hence this difference is a boundary and the homology classes of $f(x)$ and $g(x)$ are equal. \square

An important particular example is the following: $C = C', f = id_C, g = 0$. Then, if id_C is homotopic to 0, the complex C_* is said to be *contractible* (and the homotopy a *contracting homotopy*).

1.0.4 Acyclicity and Resolutions. A non-negative chain complex C over k is said to be *augmented* if there is given a k -linear map $\varepsilon : C_0 \rightarrow M$ such that $\varepsilon \circ d = 0$. Such an augmented complex is called a *resolution* of M if $H_n(C) = 0$ for $n > 0$ and $\varepsilon_* : H_0(C) \rightarrow M$ is an isomorphism. It is equivalent to the vanishing of the homology groups of the complex

$$\dots \rightarrow C_n \rightarrow C_{n-1} \rightarrow \dots \rightarrow C_0 \rightarrow M \rightarrow 0.$$

In this situation the complex C_* is said to be *acyclic*.

One of the most powerful tools of homological algebra is the following fact. Let (C_*, ε) and (C'_*, ε') be two free resolutions of M (i.e. all the modules C_n and C'_n are free; in fact projective suffices). Then there exists a chain map $f : C \rightarrow C'$ over id_M , and any two such chain maps are chain homotopic.

1.0.5 Exact Sequence of Complexes. An *exact sequence of complexes*

$$0 \rightarrow C' \rightarrow C \rightarrow C'' \rightarrow 0$$

is a pair of maps $f : C' \rightarrow C$ and $g : C \rightarrow C''$ such that the sequence of k -modules

$$0 \rightarrow C'_n \rightarrow C_n \rightarrow C''_n \rightarrow 0$$

is exact for any n . The most important consequence of this exactness hypothesis is the existence of a canonical *long exact sequence in homology*

$$\begin{aligned} \dots \rightarrow H_n(C') \rightarrow H_n(C) \rightarrow H_n(C'') \xrightarrow{\partial} H_{n-1}(C') \rightarrow H_{n-1}(C) \rightarrow \dots \\ \dots \rightarrow H_0(C'') \rightarrow 0. \end{aligned}$$

This can be proved by applying the snake lemma repeatedly. If it happens that C' (resp. C'') is acyclic, then $C \rightarrow C''$ (resp. $C' \rightarrow C$) is a quasi-isomorphism. Recall that the *boundary map* ∂ is constructed as follows. Let $x \in C'_n$ be a cycle with homology class $[x]$. Lift x as y in C_n , then $d(y)$ has a trivial image in C''_{n-1} , hence it comes from C'_{n-1} . By construction $\partial([x]) = [d(y)] \in H_{n-1}(C')$.

We now examine some particular types of complexes which will appear very often throughout the book, those for which the differential map d is of the form

$$d = \sum_{i=0}^n (-1)^i d_i : C_n \rightarrow C_{n-1}.$$

1.0.6 Definition. A *presimplicial module* C is a collection of modules $C_n, n \geq 0$, together with maps, called *face maps* or *face operators*,

$$d_i : C_n \rightarrow C_{n-1}, \quad i = 0, \dots, n$$

such that

$$d_i d_j = d_{j-1} d_i, \quad 0 \leq j < j \leq n.$$

1.0.7 Lemma. Let $d = \sum_{i=0}^n (-1)^i d_i$, then $d \circ d = 0$. In other words (C_*, d) is a complex.

Proof. The sum $d \circ d = \sum (-1)^{i+j} d_i d_j$ where $0 \leq j \leq n, 0 \leq i \leq n-1$ splits into two parts according to $i < j$ or $i \geq j$. The term $(-1)^{i+j} d_i d_j$ of the first part cancels with the term $(-1)^{j-1+i} d_{j-1} d_i$ of the second part. \square

For simplicial modules see Sect. 1.6.

A map of presimplicial modules $f : C \rightarrow C'$ is a collection of maps $f_n : C_n \rightarrow C'_n$ such that $f_{n-1} \circ d_i = d_i \circ f_n$. It implies that $f_{n-1} \circ d = d \circ f_n$ and so induces a map of complexes $f : C_* \rightarrow C'_*$. On homology the induced map is denoted $f_* : H_*(C_*) \rightarrow H_*(C'_*)$.

1.0.8. A *presimplicial homotopy* h between two presimplicial maps f and $g : C \rightarrow C'$ is a collection of maps $h_i : C_n \rightarrow C'_{n+1}, i = 0, \dots, n$ such that

$$\begin{aligned}
 d_i h_j &= h_{j-1} d_i \quad \text{for } i < j, \\
 d_i h_i &= d_i h_{i-1} \quad \text{for } 0 < i \leq n \quad (\text{cases } i = j \quad \text{and} \quad i = j + 1), \\
 d_i h_j &= h_j d_{i-1} \quad \text{for } i > j + 1, \\
 d_0 h_0 &= f \quad \text{and} \quad d_{n+1} h_n = g.
 \end{aligned}$$

1.0.9 Lemma. *If h be a presimplicial homotopy from f to g , then $h := \sum_{i=0}^n (-1)^i h_i$ is a homotopy from f to g and therefore $f_* = g_*$.*

Proof. In order to compute $dh + hd$ we remark that the term $d_i h_i$ cancels with the term $d_i h_{i-1}$. Then the term $d_i h_j$ cancels with the term $h_{j-1} d_i$ when $i < j$ and with the term $h_j d_{i-1}$ when $i > j + 1$. What is left over is $d_0 h_0$ and $d_{n+1} h_n$, whence the result. \square

1.0.10 Cochain Complexes. We will sometimes use complexes in the cohomology framework, that is *cochain complexes*

$$(C^*) \quad C^0 \xrightarrow{\delta} C^1 \xrightarrow{\delta} \dots \xrightarrow{\delta} C^n \xrightarrow{\delta} C^{n+1} \xrightarrow{\delta} \dots$$

where $\delta \circ \delta = 0$. The homology groups of this complex are called *cohomology groups*:

$$H^n(C) = \text{Ker}(\delta : C^n \rightarrow C^{n+1}) / \text{Im}(\delta : C^{n-1} \rightarrow C^n).$$

The Hom functor permits us to go from chain complexes to cochain complexes. Let C_* be a complex of k -modules and M a k -module. Put $C^n = \text{Hom}_k(C_n, M)$ and $\delta(f) = (-1)^n f \circ d$ for $f \in C^n$ (remark the sign convention), then obviously (C^n, δ) is a cochain complex.

A non-negative cochain complex can be thought of as a negative complex via the classical convention $C_{-n} = C^n$.

1.0.11 Bicomplexes. A *bicomplex* (also called a double chain complex) is a collection of modules $C_{p,q}$ indexed by two integers p and q together with a “horizontal” differential $d^h: C_{p,q} \rightarrow C_{p-1,q}$ and a “vertical” differential $d^v: C_{p,q} \rightarrow C_{p,q-1}$

$$\begin{array}{ccc}
 C_{p-1,q} & \xleftarrow{d^h} & C_{p,q} \\
 d^v \downarrow & & \downarrow d^v \\
 C_{p-1,q-1} & \xleftarrow{d^h} & C_{p,q-1}
 \end{array}$$

satisfying the following identities

$$d^v d^v = d^h d^h = d^v d^h + d^h d^v = 0.$$

Note that a complex of complexes, that is a complex in the category of complexes is almost a bicomplex. The only difference is that the squares do

commute (instead of anticommuting). But changing the sign of the boundary map of every other row yields a bicomplex.

Suppose that the bicomplex C_{**} is in the first quadrant, that is $C_{p,q} = 0$ if $p < 0$ or if $q < 0$:

$$\begin{array}{ccccccc}
 & \cdots & & \cdots & & \cdots & \\
 & \downarrow & & \downarrow & & \downarrow & \\
 C_{02} & \longleftarrow & C_{12} & \longleftarrow & C_{22} & \longleftarrow & \\
 & \downarrow & & \downarrow & & \downarrow & \\
 C_{01} & \longleftarrow & C_{11} & \longleftarrow & C_{21} & \longleftarrow & \\
 & \downarrow & & \downarrow & & \downarrow & \\
 C_{00} & \longleftarrow & C_{10} & \longleftarrow & C_{20} & \longleftarrow &
 \end{array}$$

Then the k -module

$$(\text{Tot } C_{**})_n := \bigoplus_{p+q=n} C_{p,q}$$

is well-defined (finite sum) and endowed with the differential $d = d^h + d^v$. It is a complex called the *total complex* of the bicomplex (C_{**}) and denoted $\text{Tot}(C_{**})$ or simply $\text{Tot } C$. The homology groups $H_n(\text{Tot } C)$ are called the *homology groups of the bicomplex* (C) .

There are other ways of constructing homology groups from a bicomplex. For instance one can first take the homology of the vertical complexes: $H_q(C_{p,*})$ for a fixed p . Then the horizontal differential induces a map $(d^h)_*$: $H_q(C_{p,*}) \rightarrow H_q(C_{p-1,*})$, and so, for a fixed q , there is defined a new complex whose homology groups are denoted $H_p^h H_q^v(C)$. The relationship between these groups and the homology groups of (C) (i.e. $\text{Tot } C$) is given by the study of a “spectral sequence” (see Appendix D).

Similarly one can first take the horizontal homology and second the vertical homology to get the groups $H_q^v H_p^h(C)$. This gives rise to another spectral sequence.

In general the simultaneous study of both spectral sequences gives information on the homology of the bicomplex C .

Later on we will use the following proposition which can be proved either via a spectral sequence argument or via the staircase trick.

1.0.12 Proposition. *Let $C_{**} \rightarrow C'_{**}$ be a map of bicomplexes which is a quasi-isomorphism when restricted to each column. Then the induced map on the total complexes is a quasi-isomorphism. In particular, suppose that for all q the (horizontal) homology groups $H_p(C_{*,q})$ are 0 for $p > 0$ and put $K_n = H_0(C_{*,n})$. Then $H_n(\text{Tot } C_{**}) = H_n(K_*, d^v)$. In other words, under the above hypothesis, the homology of the bicomplex is the homology of the cokernel of the first two columns.*

1.0.13 Shifted Complexes. Let (C, d) be a complex and let p be an integer. By definition $C[p]$ is the complex such that $C[p]_n = C_{n-p}$ with differential operator $(-1)^p d$. In fact it is the tensor product of $k[p]$ (that is k concentrated in degree p) with C (see infra).

1.0.14 Tensor Product of Complexes. Let R be a ring and let (C_*, d) (resp. (C'_*, d')) be a non-negative complex of right R -modules (resp. left R -modules). Their tensor product is the complex $C \otimes_R C'$ defined as follows. The module of n -chains is $(C \otimes_R C')_n = \bigoplus_{p+q=n} C_p \otimes_R C'_q$ and the differential map is defined by the formula

$$d(x \otimes y) = (d \otimes 1 + 1 \otimes d)(x \otimes y) = dx \otimes y + (-1)^{|x|} x \otimes dy .$$

1.0.15 Koszul Sign Convention. Let $f : A \rightarrow B$ and $g : C \rightarrow D$ be maps of complexes of degrees $|f|$ and $|g|$ respectively. Then $f \otimes g : A \otimes C \rightarrow B \otimes D$ is defined by $(f \otimes g)(a \otimes c) := (-1)^{|g| \cdot |a|} f(a) \otimes g(c)$. The moral is “when g jumps over a the sign $(-1)^{|g| \cdot |a|}$ pops up”. This convention simplifies a lot of expressions in homological algebra. As a consequence the composition of maps is given by $(f \otimes g) \circ (f' \otimes g') = (-1)^{|g| \cdot |f'|} (f \circ f' \otimes g \circ g')$. Similarly the additive commutator of (homogeneous) graded elements a and b is $[a, b] = ab - (-1)^{|a| \cdot |b|} ba$.

We will sometimes use Quillen’s notation \pm in place of $(-1)^{|g| \cdot |a|}$ when no confusion can arise. This notation is such that the sign is always $+$ when all the elements are of even degree.

1.0.16 Künneth Formula. If C_n and $B_n(C)$ are flat R -modules for all n , then there is a short exact sequence

$$0 \rightarrow \bigoplus_{p+q=n} H_p(C) \otimes_R H_q(C') \rightarrow \bigoplus_{p+q=n-1} \text{Tor}_1^R(H_p(C), H_q(C')) \rightarrow 0 .$$

If moreover $H_n(C)$ is flat for all n , then there is a canonical isomorphism

$$\bigoplus_{p+q=n} H_p(C) \otimes_R H_q(C') \cong H_n(C \otimes C') .$$

In particular this isomorphism holds when R is a field.

1.0.17 Universal Coefficient Theorem. Let R be a principal ideal domain and let (C_*, d) be a complex of projective R -modules. For any R -module M , the cochain complex $(\text{Hom}_R(C_*, M), \delta)$ is denoted $H^*(C, M)$. Then, for each n , there is an exact sequence

$$0 \rightarrow \text{Ext}(H_{n-1}(C), M) \rightarrow H^n(C, M) \rightarrow \text{Hom}(H_n(C), M) \rightarrow 0 .$$

In particular if R is a field, then $H^n(C, M) \rightarrow \text{Hom}(H_n(C), M)$ is an isomorphism.

The dual statement is an exact sequence

$$0 \rightarrow \text{Tor}(H^{n-1}(C), M) \rightarrow H_n(C, M) \rightarrow \text{Hom}(H^n(C), M) \rightarrow 0.$$

Exercises

E.1.0.1. Let $0 \rightarrow C' \rightarrow C \rightarrow C'' \rightarrow 0$ be an exact sequence of complexes and let α' (resp. α_1, α_2 , resp. α'') be an endomorphism of C' (resp. C , resp. C'') such that α' commutes with α_1 and that α_2 commutes with α'' . Show that, if $\alpha'_* = \alpha''_* = 0$, then $(\alpha_1 \circ \alpha_2)_* = 0$.

E.1.0.2. Let a and b be two elements of the ring A such that the left annihilator of a (resp. b) is the ideal Ab (resp. Aa). Show that the sequence

$$\dots \rightarrow A \xrightarrow{a} A \xrightarrow{b} A \xrightarrow{a} A \xrightarrow{b} \dots \rightarrow A \xrightarrow{a} A \rightarrow A/Aa \rightarrow 0$$

is a free resolution of the A -module A/Aa . Make this construction explicit in the following cases:

- (i) $A = R[\varepsilon]$, ring of dual numbers over the ring R ($\varepsilon^2 = 0$),
- (ii) $A = k[G]$ where G is a cyclic group of order $n + 1$ with generator t . Take $a = 1 - t$ and $b = 1 + t + \dots + t^n$.

1.1 Hochschild Homology

In this section we introduce Hochschild homology of an associative (not necessarily commutative) unital k -algebra (k being a commutative ring) and we state a few elementary facts about it. Our definition is the original definition of Hochschild (instead of the definition with derived functors) since it is more closely related to the definition of cyclic homology given in Chap. 2. Other important notions are introduced such as the trace map, the module of Kähler differentials, the bar complex and the normalized bar complex.

1.1.0 Bimodules. Let A be a k -algebra. A *bimodule* over A is a (symmetric) k -module M on which A operates linearly on the left and on the right in such a way that $(am)a' = a(ma')$ for $a, a' \in A$ and $m \in M$. The actions of A and k on M are always supposed to be compatible, for instance: $(\lambda a)m = \lambda(am) = a(\lambda m)$, $\lambda \in k$, $a \in A$, $m \in M$. When A has a unit element 1 we always assume that $1m = m1 = m$ for all $m \in M$. Under this unital hypothesis, the bimodule M is equivalent to a right $A \otimes A^{\text{op}}$ -module via $m(a' \otimes a) = ama'$.

The product map of A is usually denoted $\mu : A \otimes A \rightarrow A$, $\mu(a, b) = ab$.

1.1.1 Hochschild Boundary. Consider the module $C_n(A, M) := M \otimes A^{\otimes n}$ (where $\otimes = \otimes_k$ and $A^{\otimes n} = A \otimes \dots \otimes A$, n factors). The *Hochschild boundary* is the k -linear map $b : M \otimes A^{\otimes n} \rightarrow M \otimes A^{\otimes n-1}$ given by the formula

$$\begin{aligned}
 b(m, a_1, \dots, a_n) &:= (ma_1, a_2, \dots, a_n) + \sum_{i=1}^{n-1} (-1)^i (m, a_1, \dots, a_i a_{i+1}, \dots, a_n) \\
 &\quad + (-1)^n (a_n m, a_1, \dots, a_{n-1}).
 \end{aligned}$$

This formula makes sense because A is an algebra and M is an A -bimodule. The main example we are going to look at is $M = A$. It will prove useful to introduce the operators $d_i: M \otimes A^{\otimes n} \rightarrow M \otimes A^{\otimes n-1}$ given by

$$\begin{aligned}
 d_0(m, a_1, \dots, a_n) &:= (ma_1, a_2, \dots, a_n), \\
 (1.1.1.1) \quad d_i(m, a_1, \dots, a_n) &:= (m, a_1, \dots, a_i a_{i+1}, \dots, a_n) \quad \text{for } 1 \leq i < n, \\
 d_n(m, a_1, \dots, a_n) &:= (a_n m, a_1, \dots, a_{n-1}).
 \end{aligned}$$

With this notation one has

$$b = \sum_{i=0}^n (-1)^i d_i.$$

1.1.2 Lemma. $b \circ b = 0$.

Proof. It is immediate to check that

$$d_i d_j = d_{j-1} d_i \quad \text{for } 0 \leq i < j \leq n,$$

(hence $M \otimes A^{\otimes n}$ is a presimplicial module), from which $b \circ b = 0$ follows (cf. 1.0.6 and 1.0.7). \square

1.1.3 Hochschild Complex and Hochschild Homology Groups. As a consequence of lemma 1.1.2 we get the *Hochschild complex*

$$\begin{aligned}
 C(A, M) = C_*(A, M) : \quad \dots \rightarrow M \otimes A^{\otimes n} \xrightarrow{b} M \otimes A^{\otimes n-1} \xrightarrow{b} \dots \\
 \dots \xrightarrow{b} M \otimes A \xrightarrow{b} M
 \end{aligned}$$

where the module $M \otimes A^{\otimes n}$ is in degree n .

In the case where $M = A$ the Hochschild complex

$$C(A) = C_*(A) : \quad \dots \rightarrow A^{\otimes n+1} \xrightarrow{b} A^{\otimes n} \xrightarrow{b} \dots \xrightarrow{b} A^{\otimes 2} \xrightarrow{b} A$$

is sometimes called the *cyclic bar complex* in the literature.

By definition the n th *Hochschild homology group* of the unital k -algebra A with coefficients in the A -bimodule M is the n th homology group of the Hochschild complex $(C_*(A, M), b)$. The direct sum $\bigoplus_{n \geq 0} H_n(A, M)$ is denoted $H_*(A, M)$ (see 1.1.4 and 1.1.17 for other notation).

A priori one does not need the existence of a unit to construct the Hochschild complex. However Hochschild homology of non-unital algebras is defined slightly differently. This will be dealt with in Sect. 1.4.

1.1.4 Functoriality, Notation HH_* . This construction is obviously *functorial* in M : a bimodule homomorphism $f : M \rightarrow M'$ induces a map $f_* : H_*(A, M) \rightarrow H_*(A, M')$, $f_*(m, a_1, \dots, a_n) = (f(m), a_1, \dots, a_n)$. It is also functorial in A in the following sense. Let $g : A \rightarrow A'$ be a k -algebra map and M' be an A' -bimodule. Via g the module M' can be considered as an A -bimodule and there is defined a map $g_* : H_*(A, M') \rightarrow H_*(A', M')$ given by $g_*(m, a_1, \dots, a_n) = (m, g(a_1), \dots, g(a_n))$.

In the particular case $M = A$ we write $C_*(A)$ instead of $C_*(A, A)$ and $HH_*(A)$ instead of $H_*(A, A)$. Any k -algebra map $f : A \rightarrow A'$ (which need not preserve the unit) induces a homomorphism $f_* : HH_n(A) \rightarrow HH_n(A')$. So HH_n is a (covariant) functor from the category of associative k -algebras to the category of k -modules. This functor respects the product, that is $HH_n(A \times A') = HH_n(A) \oplus HH_n(A')$ (cf. Exercise E.1.1.1).

1.1.5 Module Structure Over the Center. Let $Z(A)$ be the *center* of A , i.e. $Z(A) = \{z \in A \mid za = az \text{ for all } a \in A\}$. There is an action of $Z(A)$ on $C_n(A, M)$ given by $z \cdot (m, a_1, \dots, a_n) = (zm, a_1, \dots, a_n)$. Since z commutes with A , this is an endomorphism of the complex. So $H_n(A, M)$ is a module over $Z(A)$. In fact the right action (mz instead of zm in the formula) gives the same module structure on the homology groups (cf. Exercise E.1.1.2). In particular when A is commutative then $HH_*(A)$ is an A -module.

1.1.6 Elementary Computations. The group

$$H_0(A, M) = M_A = M / \{am - ma \mid a \in A, m \in M\}$$

is also called the *module of coinvariants* of M by A . Let $[A, A]$ denote the additive commutator sub- k -module generated by $[a, a'] = aa' - a'a$, for $a, a' \in A$. Then $HH_0(A) = A/[A, A]$. If A is commutative, then $HH_0(A) = A$. When $A = k$ the Hochschild complex for $M = k$ is

$$\dots \rightarrow k \xrightarrow{1} k \xrightarrow{0} \dots \xrightarrow{1} k \xrightarrow{0} k$$

therefore $HH_0(k) = k$ and $HH_n(k) = 0$ for $n > 0$.

Let $k[\varepsilon]$ be the algebra of dual numbers (that is $\varepsilon^2 = 0$). If 2 is invertible in k , then for any $n \geq 1$, $1 \otimes \varepsilon^{\otimes(2n+1)}$ (resp. $\varepsilon \otimes \varepsilon^{\otimes 2n}$) is a cocycle whose homology class spans $HH_{2n+1}(k[\varepsilon])$ (resp. $HH_{2n}(k[\varepsilon])$).

Denote by $\mathcal{M}_r(R)$ the associative ring of $r \times r$ -matrices with entries in the ring R .

1.1.7 Lemma. *For any ring R the abelianized trace map $Tr : \mathcal{M}_r(R) \rightarrow R/[R, R]$ induces an isomorphism $Tr_* : \mathcal{M}_r(R)/[\mathcal{M}_r(R), \mathcal{M}_r(R)] \rightarrow R/[R, R]$.*

Proof. The trace map $\text{tr} : \mathcal{M}_r(R) \rightarrow R$ is defined by $\text{tr}(\alpha) = \sum_i \alpha_{ii}$, and the abelianized trace map Tr is the composition with the projection onto $R/[R, R]$. It is sufficient to show that $\text{Ker}(\text{Tr}) = [\mathcal{M}_r(R), \mathcal{M}_r(R)]$.

The fundamental property of the abelianized trace map is $\text{Tr}(\alpha\beta) = \text{Tr}(\beta\alpha)$. It implies $\text{Ker}(\text{Tr}) \supseteq [\mathcal{M}_r(R), \mathcal{M}_r(R)]$.

The module $\text{Ker}(\text{Tr})$ is generated by the elementary matrices $E_{ij}(a)$, $i \neq j$, (a in the (i, j) -position and 0 everywhere else) and the diagonal matrices α such that $\sum_i \alpha_{ii} \in [R, R]$. From the equality $E_{ij}(a) = [E_{ij}(a), E_{jj}(1)]$, $i \neq j$, we deduce that $E_{ij}(a) \in [\mathcal{M}_r(R), \mathcal{M}_r(R)]$. From the equality $[E_{ij}(a), E_{ji}(1)] = E_{ii}(a) - E_{jj}(a)$ we deduce that a diagonal matrix which is in $\text{Ker}(\text{Tr})$ is equivalent to $E_{11}(c)$, with $c \in [R, R]$, modulo $[\mathcal{M}_r(R), \mathcal{M}_r(R)]$. Therefore $\text{Ker}(\text{Tr}) \subseteq [\mathcal{M}_r(R), \mathcal{M}_r(R)]$. \square

1.1.8 Corollary. $HH_0(\mathcal{M}_r(A)) = A/[A, A]$. \square

This is in fact a particular case of a more general theorem valid for all n , see the next section on Morita invariance.

1.1.9 Kähler Differentials. For A unital and commutative let $\Omega_{A|k}^1$ be the A -module of *Kähler differentials*. It is generated by the k -linear symbols da for $a \in A$ (so $d(\lambda a + \mu b) = \lambda da + \mu db$, $\lambda, \mu \in k$ and $a, b \in A$) with the relation

$$(1.1.9.1) \quad d(ab) = a(db) + b(da), \quad a, b \in A,$$

Remark that $du = 0$ for any $u \in k$. See also 1.3.7 for another definition of Ω^1 .

1.1.10 Proposition. *If A is a unital and commutative, then there is a canonical isomorphism $HH_1(A) \cong \Omega_{A|k}^1$. If M is a symmetric bimodule (i.e. $am = ma$ for all $a \in A$ and $m \in M$), then $H_1(A, M) \cong M \otimes_A \Omega_{A|k}^1$.*

Proof. Since A is commutative the map $b : A \otimes A \rightarrow A$ is trivial. Therefore $HH_1(A)$ is the quotient of $A \otimes A$ by the relation

$$(1.1.10.1) \quad ab \otimes c - a \otimes bc + ca \otimes b = 0.$$

The map $HH_1(A) \rightarrow \Omega_{A|k}^1$, which sends the class of $a \otimes b$ to adb , is well-defined because of (1.1.9.1). In the other direction adb is sent to the class of $a \otimes b$ which is a cycle because A is commutative. It is obviously a module homomorphism which sends $d(ab) - adb - bda$ to 0 because of (1.1.10.1). It is immediate to check that these two maps are inverse to each other. \square

More information on these matters is given throughout the book, but especially in Sect. 1.3 and in Chap. 3, where the relationship between Hochschild homology and exterior differential forms is treated.

The comparison of the definition of Hochschild homology given above and the definition in terms of derived functors (in fact Tor-functors) is via the so-called “bar resolution” that we now introduce.

1.1.11 Bar Complex. Let A^{op} be the opposite algebra of A . The product of a and b in A^{op} is given by $a \cdot b = ba$. Let $A^e = A \otimes A^{\text{op}}$ be the enveloping algebra of the associative and unital algebra A . The left A^e -module structure of A is given by $(a \otimes a')c = aca'$. Consider the following complex, called the *bar complex*

$$(1.1.11.1) \quad C_*^{\text{bar}} : \quad \dots \rightarrow A^{\otimes n+1} \xrightarrow{b'} A^{\otimes n} \xrightarrow{b'} \dots \xrightarrow{b'} A^{\otimes 2}$$

where $A^{\otimes 2}$ is in degree 0 and where $b' = \sum_{i=0}^{n-1} (-1)^i d_i$ (note that the sum is only up to $n - 1$) with the notation introduced in 1.1.1. The map $b' = \mu : A \otimes A \rightarrow A$ is an augmentation for the bar complex.

1.1.12 Proposition-definition. Let A be a unital k -algebra. The complex C_*^{bar} is a resolution of the A^e -module A . It is called the “bar resolution” of A .

An n -chain of the bar resolution is often denoted by $a_0[a_1|a_2|\dots|a_n]a_{n+1}$.

Proof. It is immediate to see that the cokernel of the last map is precisely $\mu : A^{\otimes 2} \rightarrow A$. The operator

$$s : A^{\otimes n} \rightarrow A^{\otimes n+1}, \quad s(a_1, \dots, a_n) = (1, a_1, \dots, a_n),$$

called the *extra degeneracy*, satisfies the formulas $d_i s = s d_{i-1}$ for $i = 1, \dots, n - 1$ and $d_0 s = id$. Therefore $b' s + s b' = id$ and s is a contracting homotopy, showing that the b' -complex is acyclic (cf. 1.0.3). \square

Remarks. We only used the fact that A has a left unit in the preceding proof (to check $d \circ s = id$). If A has a right unit then take $s(a_1, \dots, a_n) = (a_1, \dots, a_n, 1)$. Remark also that the boundary map b' of the bar complex is completely determined by the following conditions

- (a) b' is left A -module homomorphism,
- (b) $b' = \mu$ on $A^{\otimes 2}$,
- (c) $b' s + s b' = id$.

In fact there is an isomorphism $C_*^{\text{bar}}(A) \cong C_*(A, A \otimes A^{\text{op}})$.

1.1.13 Proposition. If the unital algebra A is projective as a module over k , then for any A -bimodule M there is an isomorphism

$$H_n(A, M) = \text{Tor}_n^{A^e}(M, A).$$

Proof. Since A is k -projective by hypothesis, $A^{\otimes n}$ is also k -projective and $A^{\otimes n+2} = A \otimes A^{\otimes n} \otimes A$ is an A^e -projective left module (the module structure is given by $(\lambda, \mu) \cdot (a_0, \dots, a_{n+1}) = (\lambda a_0, a_1, \dots, a_n, a_{n+1} \mu)$). So the bar resolution is a projective resolution of A as an A^e -module.

Upon tensoring this projective resolution with M considered as a right module over A^e we obtain the Hochschild complex, because $1_M \otimes b'$ becomes b under $M \otimes_{A^e} A^{\otimes n+2} \cong M \otimes A^{\otimes n}$. This proves the proposition. \square

So, under the hypothesis that A is projective over k , Hochschild homology is a particular example of the homology theory of augmented rings, the augmentation (in the sense of Cartan-Eilenberg) being $A \otimes A^{\text{op}} \rightarrow A, a \otimes b \mapsto ab$. Suppose, moreover, that A is augmented over k via $\varepsilon : A \rightarrow k$. Let M be a right A -module, that we consider as an A -bimodule, denoted M^ε , with left A -module structure given by $a \cdot m = \varepsilon(a)m$. Then (cf. [CE, p. 186]), there is an isomorphism

$$H_n(A, M^\varepsilon) \cong \text{Tor}_n^A(M, k).$$

Note that thanks to a theorem of D. Lazard, (cf. Bourbaki [1980, p. 14]), one can replace the hypothesis “ A projective over k ” by “ A flat over k ” in the above proposition.

1.1.14 Normalized Hochschild Complex. When A is unital there is a large subcomplex D_* of the Hochschild complex which is acyclic, and it is often helpful to get rid of it. The submodule D_n of $M \otimes A^{\otimes n}$ is generated by the so-called *degenerate elements*, that is the elements (m, a_1, \dots, a_n) for which at least one of the a_i 's is equal to 1. The quotient of the Hochschild complex by the sub-complex D_* of degenerate elements is called the *normalized Hochschild complex*. Put $\bar{A} = A/k$ (where k is mapped into $k \cdot 1$ in A), then $M \otimes A^{\otimes n}/D_n = M \otimes \bar{A}^{\otimes n}$. It is denoted by $\bar{C}_n(A, M)$, or simply by $\bar{C}_n(A)$ when $M = A$.

1.1.15 Proposition. *The complex D_* is acyclic and the projection map $C_*(A, M) \rightarrow \bar{C}_*(A, M)$ is a quasi-isomorphism of complexes.*

Proof. This is a general fact about simplicial modules and will be proved in 1.6.5. \square

1.1.16 Relative Hochschild Homology. Let I be a two-sided ideal of A with quotient A/I . The *relative Hochschild homology* groups $HH_n(A, I)$ (not to be confused with $H_n(A, I)$) are, by definition, the homology groups of the complex $\text{Ker}(C(A) \rightarrow C(A/I))$. They fit into the long exact sequence:

$$\dots \rightarrow HH_n(A, I) \rightarrow HH_n(A) \rightarrow HH_n(A/I) \rightarrow HH_{n-1}(A, I) \rightarrow \dots$$

which is the homology exact sequence of a short exact sequence of complexes (cf. 1.0.5). More generally for any k -algebra map $A \rightarrow B$ one can define relative Hochschild homology groups $HH_n(A \rightarrow B)$, which fit into a long exact sequence by taking the homology of the cone-complex of $C_*(A) \rightarrow C_*(B)$. Similarly, one can abstractly define *birelative Hochschild homology* groups, etc.

The next result is about *localization* of Hochschild homology.

1.1.17 Proposition. *Let $Z(A)$ be the center of A and let S be a multiplicative subset of $Z(A)$ containing 1 but not 0. For any left A -module M the localization of M at S is $M_S = Z(A)_S \otimes_A M$, where $Z(A)_S$ is $Z(A)$ localized at S . When A is flat over k , there are canonical isomorphisms*

$$H_n(A, M)_S \cong H_n(A, M_S) \cong H_n(A_S, M_S).$$

Proof. Since we suppose A flat over k , we can use, by proposition 1.1.13, the definition of Hochschild homology in terms of derived functors. The three family of groups under investigation define homological functors (∂ -functors in the sense of Cartan-Eilenberg [CE]) of the A -bimodule M . They are equipped with natural maps

$$H_n(A, M)_S \leftarrow H_n(A, M_S) \rightarrow H_n(A_S, M_S).$$

To prove that they are isomorphisms it is sufficient to treat the case $n = 0$ (cf. loc. cit.), for which it can be checked by direct inspection. \square

1.1.18 Change of Ground Ring. Though the notation does not mention k , the Hochschild homology groups depend on the choice of k . For instance $HH_1(\mathbb{C}) = 0$ if $k = \mathbb{C}$ but $HH_1(\mathbb{C}) \neq 0$ if $k = \mathbb{Q}$. If we want to emphasize the choice of the ground ring k , we write $HH_*(A|k)$ or $HH_*^k(A)$. For any ring homomorphism $k \rightarrow K$ (always preserving the unit) a K -algebra A is also a k -algebra. It is immediate that there is defined a canonical map of k -modules

$$HH_*(A|k) \rightarrow HH_*(A|K).$$

1.1.19 Localization of the Ground Ring. Let S be a multiplicative subset of k (containing 1 and not 0) and let k_S be the localization of k at S . If A is flat over k , then the induced morphism $HH_*(A|k) \otimes_k k_S \rightarrow HH_*(A_S|k_S)$ is an isomorphism. In particular, if A is a \mathbb{Q} -algebra, then $HH_*(A|\mathbb{Z}) \otimes \mathbb{Q} = HH_*(A|\mathbb{Q})$.

Exercises

E.1.1.1. Let A and A' be two unital k -algebras. Show that there is a canonical isomorphism

$$HH_*(A \times A') \cong HH_*(A) \oplus HH_*(A').$$

[If A and A' are flat over k one can use the Tor definition. Otherwise one can construct an explicit homotopy, see 1.2.15.]

E.1.1.2. A left (resp. right) action of $z \in Z(A)$ on $C_*(A, M)$ is given by

$$z \cdot (m, a_1, \dots, a_n) = (zm, a_1, \dots, a_n)$$

[resp. $(m, a_1, \dots, a_n) \cdot z = (mz, a_1, \dots, a_n)$]. Show that these two actions are homotopic. [There exists a simplicial homotopy, $h_i(m, a_1, \dots, a_n) = (m, a_1, \dots, a_i, z, a_{i+1}, \dots, a_n)$.]

E.1.1.3. Let $f_i : A_i \rightarrow A_{i+1}$, $i \in \mathbb{N}$, be an infinite family of k -algebra homomorphisms, whose inductive limit is denoted $\lim_i A_i$. Show that Hochschild homology commutes with inductive limits:

$$\operatorname{colim}_i HH_n(A_i) \cong HH_n(\operatorname{colim}_i A_i).$$

E.1.1.4. Let G be a discrete group and M a $k[G]$ -bimodule, where $k[G]$ is the group algebra of G . Let \widetilde{M} be the k -module M considered as a right G -module for the adjoint action $m^g = g^{-1}mg$. Show that there is a canonical isomorphism

$$H_*(k[G], M) \cong H_*(G, \widetilde{M}),$$

where the latter group is the homology of the discrete group G (cf. Appendix C and 7.4.2).

E.1.1.5. Find a unital k -algebra A such that the map $k \rightarrow HH_0(A)$ is zero. [Try $A = k[u, v]/(uv - vu = 1)$ (non-commutative polynomials).]

E.1.1.6. Let I and J be two 2-sided ideals of the unital k -algebra A . Define birelative Hochschild homology $HH_*(A; I, J)$ so that there is a long exact sequence

$$\begin{aligned} \dots \rightarrow HH_n(A, I) \rightarrow HH_n(A/J, I + J/J) \\ \rightarrow HH_{n-1}(A; I, J) \rightarrow HH_{n-1}(A, I) \rightarrow \dots \end{aligned}$$

Suppose that $I \cap J = 0$. Show that $HH_n(A; I, J) = 0$ for $n = 0$ and that $HH_1(A; I, J) = I \otimes_{A^e} J$.

E.1.1.7. Let $0 \rightarrow M' \rightarrow M \rightarrow M'' \rightarrow 0$ be an exact sequence of A -bimodules which are flat over k . Show that there is a long exact sequence in homology

$$\dots \rightarrow H_n(A, M') \rightarrow H_n(A, M) \rightarrow H_n(A, M'') \rightarrow H_{n-1}(A, M') \rightarrow \dots$$

E.1.1.8. Let A be a commutative algebra and let $A \subset A'$ be an étale extension. Show that

$$HH_*(A') \cong HH_*(A) \otimes_{A^e} A'$$

(If A is flat over k use the Tor definition. For the general case see Geller-Weibel [1991].)

1.2 The Trace Map and Morita Invariance

The trace map for matrices can be extended to the Hochschild complex. It induces an isomorphism on homology (Morita invariance). In fact Morita invariance can be proved in full generality. The existence of the generalized trace map permits us to enlarge the set of morphisms of the category of algebras on which Hochschild homology is defined. A slight generalization using separable algebras leads to the computation of Hochschild homology of triangular matrix algebras.

1.2.0 The Trace. Let M be a bimodule over the k -algebra A and let $\mathcal{M}_r(M)$ be the module of $r \times r$ matrices with coefficients in M .

Bordering by zeroes

$$\alpha \mapsto \begin{bmatrix} & & & 0 \\ & \alpha & & \cdot \\ & & & \cdot \\ 0 & \cdot & 0 & 0 \end{bmatrix}$$

defines an inclusion $\text{inc}: \mathcal{M}_r(M) \rightarrow \mathcal{M}_{r+1}(M)$. In the limit we get $\cup_r \mathcal{M}_r(M) = \mathcal{M}_\infty(M)$ which we usually denote by $\mathcal{M}(M)$. When $M = A$ this inclusion is a map of algebras which does not respect the unit.

The (ordinary) *trace map* $\text{tr}: \mathcal{M}_r(M) \rightarrow M$ is given by

$$\text{tr}(\alpha) = \sum_{i=1}^r \alpha_{ii} .$$

It is clear that tr is compatible with inc and defines $\text{tr}: \mathcal{M}(M) \rightarrow M$.

1.2.1 Definition. The *generalized trace map* (or simply trace map)

$$\text{tr}: \mathcal{M}_r(M) \otimes \mathcal{M}_r(A)^{\otimes n} \rightarrow M \otimes A^{\otimes n}$$

is given by

$$\text{tr}(\alpha \otimes \beta \otimes \dots \otimes \eta) = \sum \alpha_{i_0 i_1} \otimes \beta_{i_1 i_2} \otimes \dots \otimes \eta_{i_n i_0} ,$$

where the sum is extended over all possible sets of indices (i_0, \dots, i_n) .

The module $\mathcal{M}_r(M)$ (resp. $\mathcal{M}_r(A)$) can be identified with $\mathcal{M}_r(k) \otimes M$ (resp. $\mathcal{M}_r(k) \otimes A$). Under this identification any element of $\mathcal{M}_r(M)$ (resp. $\mathcal{M}_r(A)$) is a sum of elements like ua with $u \in \mathcal{M}_r(k)$ and $a \in M$ (resp. $a \in A$).

1.2.2 Lemma. Let $u_i \in \mathcal{M}_r(k)$, $a_0 \in M$ and $a_i \in A$ for $i \geq 1$. The *generalized trace map* takes the form

$$(1.2.2.1) \quad \text{tr}(u_0 a_0 \otimes \dots \otimes u_n a_n) = \text{tr}(u_0 \dots u_n) a_0 \otimes \dots \otimes a_n .$$

Proof. Since $(ua)_{ij} = u_{ij}a$ one has

$$\mathrm{tr}(u_0a_0 \otimes \dots \otimes u_na_n) = \sum (u_0)_{i_0i_1} (u_1)_{i_1i_2} \dots (u_n)_{i_ni_0} a_0 \otimes \dots \otimes a_n .$$

The expected formula follows from the identity

$$\mathrm{tr}(u_0 \dots u_n) = \sum (u_0)_{i_0i_1} (u_1)_{i_1i_2} \dots (u_n)_{i_ni_0} . \quad \square$$

1.2.3 Corollary. *The generalized trace map is a morphism of complexes from $C_*(\mathcal{M}_r(A), \mathcal{M}_r(M))$ to $C_*(A, M)$.*

Proof. In fact we can prove that tr is a morphism of presimplicial modules. Using lemma 1.2.2 it is sufficient to verify that $d_i \circ \mathrm{tr} = \mathrm{tr} \circ d_i$ on elements like $u_0a_0 \otimes \dots \otimes u_na_n$. It is immediate for $i = 0, \dots, n-1$. For $i = n$ it follows from the identity $\mathrm{tr}(vu_n) = \mathrm{tr}(u_nv)$ in the commutative ring k . \square

In the following theorem tr_* and inc_* denote the morphisms induced on homology by the trace map tr and the inclusion map inc respectively.

1.2.4 Theorem (Morita Invariance for Matrices). *Let A be a unital k -algebra. Then for any $r \geq 1$ (including $r = \infty$) the maps*

$$\mathrm{tr}_* : H_*(\mathcal{M}_r(A), \mathcal{M}_r(M)) \rightarrow H_*(A, M)$$

and

$$\mathrm{inc}_* : H_*(A, M) \rightarrow H_*(\mathcal{M}_r(A), \mathcal{M}_r(M))$$

are isomorphisms and inverse to each other.

Proof. It is immediate that $\mathrm{tr} \circ \mathrm{inc} = \mathrm{id}$, therefore it suffices to prove that $\mathrm{inc} \circ \mathrm{tr}$ is homotopic to id . In fact there is a presimplicial homotopy $h = \sum (-1)^i h_i$ (cf. 1.0.8) constructed as follows. For $i = (0, \dots, n)$ let $h_i : \mathcal{M}_r(M) \otimes \mathcal{M}_r(A)^{\otimes n} \rightarrow \mathcal{M}_r(M) \otimes \mathcal{M}_r(A)^{\otimes n+1}$ be defined by the formula

$$h_i(\alpha^0, \dots, \alpha^n) = \sum E_{j1}(\alpha_{jk}^0) \otimes E_{11}(\alpha_{km}^1) \otimes \dots \\ \dots \otimes E_{11}(\alpha_{pq}^i) \otimes E_{1q}(1) \otimes \alpha^{i+1} \otimes \alpha^{i+2} \otimes \dots \otimes \alpha^n ,$$

where the sum is extended over all possible sets of indices (j, k, m, \dots, p, q) . In this formula α^0 is in $\mathcal{M}_r(M)$ and the others α^s are in $\mathcal{M}_r(A)$; the index s is put as a superscript in order to make the formula more readable.

The maps h_i satisfy the first three relations of 1.0.8. We verify only the formula $d_0h_1 = h_0d_0$ and leave the others to the diligent reader. On one hand it comes

$$d_0h_1(\alpha^0, \dots, \alpha^n) = \sum E_{j1}(\alpha_{jk}^0 \alpha_{km}^1) \otimes E_{1m}(1) \otimes \alpha^2 \otimes \dots \otimes \alpha^n$$

because $E_{j1}(a)E_{11}(b) = E_{j1}(ab)$. On the other hand

$$\begin{aligned} h_0 d_0 (\alpha^0, \dots, \alpha^n) &= h_0 (\alpha^0 \alpha^1, \alpha^2, \dots, \alpha^n) \\ &= \sum E_{j_1} \left((\alpha^0 \alpha^1)_{j_1} \right) \otimes E_{1l}(1) \alpha^2 \otimes \dots \alpha^n . \end{aligned}$$

But $(\alpha^0 \alpha^1)_{j_m} = \sum_k \alpha_{j_k}^0 \alpha_{km}^1$, therefore we have $d_0 h_1 = h_0 d_0$.

Put $h = \sum_{i=0}^n (-1)^i h_i$, for instance $h(\alpha) = \sum E_{j_1}(\alpha_{jk}) \otimes E_{1k}(1)$ when $n = 0$, and $h(\alpha, \beta) = E_{j_1}(\alpha_{jk} \otimes E_{1k}(1) \otimes \beta - E_{j_1}(\alpha_{jk}) \otimes E_{11}(\beta_{kl}) E_{1l}(1))$ when $n = 1$.

Then from the relations above one concludes that $hd + dh = d_0 h_0 - d_{n+1} h_n$ (cf. lemma 1.0.9). One computes $d_0 h_0 = id$ and $d_{n+1} h_n = inc \circ tr$. Therefore id is homotopic to $inc \circ tr$ as wanted and this finishes the case r finite.

For $r = \infty$ we have $\mathcal{M}(A) = \lim_r \mathcal{M}_r(A)$, hence $H_*(\mathcal{M}(A), \mathcal{M}(M)) = \lim_r H_*(\mathcal{M}_r(A), \mathcal{M}_r(M)) = H_*(A, M)$ (cf. Exercise E.1.1.3). Note that $\mathcal{M}(A)$ is not unital, however it is H -unital (cf. section 1.4). \square

The general framework of Morita equivalence is as follows.

1.2.5 Definition. Let R and S be two unital k -algebras. They are called *Morita equivalent* if there is an R - S -bimodule P , an S - R -bimodule Q , an isomorphism of R -bimodules $u : P \otimes_S Q \cong R$ and an isomorphism of S -bimodules $v : Q \otimes_R P \cong S$.

This implies that we have the following equivalence of categories:

- $Q \otimes_R -$: left R -mod \rightarrow left S -mod (with inverse $P \otimes_S -$),
- $- \otimes_R P$: right R -mod \rightarrow right S -mod (with inverse $- \otimes_S Q$),
- $Q \otimes_R - \otimes_R P$: R -bimod \rightarrow S -bimod (with inverse $P \otimes_S - \otimes_S Q$).

As a consequence P is projective as a left R -module and as a right S -module, and similarly for Q .

1.2.6 Example. Let A be a ring, then A and $\mathcal{M}_r(A)$ are Morita equivalent. For $R = A$ and $S = \mathcal{M}_r(A)$, take $P = A^r$ (row vectors) and $Q = A^r$ (column vectors).

1.2.7 Theorem. *If R and S are Morita equivalent k -algebras and M is an R -bimodule, then there is a natural isomorphism*

$$H_*(R, M) \cong H_*(S, Q \otimes_R M \otimes_R P) .$$

Proof. First we show that the isomorphisms u and v can be supposed to satisfy the following formulas:

$$(1.2.7.1) \quad \begin{aligned} qu(p \otimes q') &= v(q \otimes p)q' , \\ pv(q \otimes p') &= u(p \otimes q)p' , \quad \text{for all } p, p' \in P \quad \text{and all } q, q' \in Q . \end{aligned}$$

In fact the first formula is a consequence of the second.

As a consequence u (resp. v) becomes a ring homomorphism for the product $(p \otimes q)(p' \otimes q') = p \otimes v(q \otimes p')q'$ (resp. $(q \otimes p)(q' \otimes p') = q \otimes u(p \otimes q')p'$). The two composite isomorphisms

$$P \otimes_S Q \otimes_R P \xrightarrow{u \otimes id} R \otimes_R P \cong P$$

and $P \otimes_S Q \otimes_R P \xrightarrow{id \otimes v} P \otimes_S S \cong P$

differ only by an automorphism a of P . Thus a can be considered as an element of R^\times (= group of invertible elements of R) because tensoring with id_Q gives $\text{Aut}_{R-S}(P, P) \cong \text{Aut}_R(R, R) = R^\times$. In fact a is in the center of R . Replacing u by au (which is still an isomorphism) makes the first formula hold. The second formula follows immediately (cf. Bass [1968, p. 60–62]).

From now on the isomorphisms u and v are supposed to satisfy (1.2.7.1).

There exist elements $\{p_1, \dots, p_s\}$ and $\{p'_1, \dots, p'_t\}$ in P and $\{q_1, \dots, q_s\}$ and $\{q'_1, \dots, q'_t\}$ in Q such that $u(\sum p_j \otimes q_j) = 1$ and $v(\sum q'_k \otimes p'_k) = 1$ because u and v are isomorphisms. For each $n \geq 0$ define $\psi_n : (M \otimes R^{\otimes n}) \rightarrow (Q \otimes_R M \otimes_R P, S^{\otimes n})$ by

$$\psi_n(m, a_1, \dots, a_n) = \sum (q_{j_0} \otimes m \otimes p_{j_1}, v(q_{j_1} \otimes a_1 p_{j_2}), \dots, v(q_{j_n} \otimes a_n p_{j_0}))$$

where the sum is taken over all sets of indices (j_0, \dots, j_n) such that $1 \leq j_* \leq s$, and define $\phi_n : (Q \otimes_R M \otimes_R P, S^{\otimes n}) \rightarrow M \otimes R^{\otimes n}$ by

$$\phi_n(q \otimes m \otimes p, b_1, \dots, b_n) = \sum (u(p'_{k_0} \otimes q) m u(p \otimes q'_{k_1}), u(p'_{k_1} \otimes b_1 q'_{k_2}), \dots, u(p'_{k_n} \otimes b_n q'_{k_0}))$$

where the sum is taken over all sets of indices $(k_0, k_1, k_2, \dots, k_n)$ such that $1 \leq k_* \leq t$.

When u and v satisfy (1.2.7.1) ϕ and ψ are complex homomorphisms. The composite $\phi\psi$ is homotopic to the identity through a simplicial homotopy h defined by

$$h_i(m, a_1, \dots, a_n) = \sum \left(m u(p_{j_0} \otimes q'_{k_0}), u(p'_{k_0} \otimes q_{j_0}) a_1 u(p_{j_1} \otimes q'_{k_1}), \dots \right. \\ \left. u(p'_{k_{i-1}} \otimes q_{j_{i-1}}) a_i u(p_{j_{i+1}} \otimes q'_{k_{i+1}}), u(p'_{k_i} \otimes q_{j_i}), a_{i+1}, \dots, a_n \right).$$

where the sum is extended over all sequences (j_0, \dots, j_i) and (k_0, \dots, k_i) such that $1 \leq j_* \leq s$ and $1 \leq k_* \leq t$. Verifying that the h_i 's form a simplicial homotopy is left to the reader. Similarly $\psi\phi$ is homotopic to the identity. \square

1.2.8 Example. Let e be an idempotent ($e^2 = e$) in R such that $R = ReR$. Then put $S = eRe$. These two algebras are Morita equivalent for $P = Re$ and $Q = eR$. One of the maps is simply the inclusion of S into R . For instance if $R = \mathcal{M}_p(A)$ and $e = E_{11}$, then $S \cong A$, $\phi = \text{inc}$ and $\psi = \text{tr}$.

At first glance theorem 1.2.7 does not seem to be symmetric in R and S . However, if one puts $U = M \otimes_R P$, then $M \cong U \otimes_S Q$ and the homology isomorphism becomes $H_*(R, U \otimes_S Q) \cong H_*(S, Q \otimes_R U)$, which is a symmetric formula.

1.2.9 Functoriality of Hochschild Homology. We already noted that $HH_*(A)$ is functorial in the k -algebra A . In fact we can enlarge the category of k -algebras with more morphisms as follows.

Let $(k\text{-ALG})$ be the category whose objects are unital k -algebras A and such that a morphism from A to B is the isomorphism class of an A - B -bimodule ${}_A M_B$ which is projective and finitely generated as a B -module (the “ordinary” category of algebras over k is denoted $(k\text{-Alg})$). Composition of morphisms is by tensor product of modules: ${}_B N_C \circ_A M_B = ({}_A M_B) \otimes_B ({}_B N_C)$.

The functor $(k\text{-ALG}) \rightarrow (k\text{-ALG})$ sends $f : A \rightarrow B$ to the isomorphism class of ${}_A B_B$ with the A -module structure coming from f . In this category the generalized trace map defines a morphism from $\mathcal{M}_r(A)$ to A .

1.2.10 Proposition. *Hochschild homology $A \mapsto HH_n(A)$ is a well-defined functor from the category $(k\text{-ALG})$ to the category of k -modules.*

Proof. Let $M = {}_A M_B$ be a morphism from A to B . Then the action of A on M and the zero action of A on B defines a k -algebra morphism $A \rightarrow \text{End}_B(M \oplus B)$ (not preserving the unit element). The two k -algebras $\text{End}_B(M \oplus B)$ and B are Morita equivalent: take $P = M$ and $Q = (M \oplus B)^* = \text{Hom}_B(M \oplus B, B)$. Hence the morphism from $HH_n(A)$ to $HH_n(B)$ is, by 1.2.7, the composite

$$HH_n(A) \rightarrow HH_n(\text{End}(M)) \cong HH_n(B).$$

Checking that $(M \circ N) = (N \otimes M)_*$ is a straightforward calculation. □

Remark. More generally, if V is a B -bimodule and ${}_A M_B$ a bimodule defining morphism in $(k\text{-ALG})$, then there is defined an A -bimodule V' and a k -module homomorphism $H_*(A, V') \rightarrow H_*(B, V)$. The module V' is $f^*(M \otimes_B V \otimes_B M^*)$. More details on Morita invariance can be found in Kassel [1989a].

In some instances (such as in theorem 1.2.15 below) it is helpful to be able to deal with a non-commutative ground ring as follows.

1.2.11 HH Over Non-commutative Ground Ring. Let A be a not necessarily commutative ring with unit and let S be a subring of A (so that in particular A is an S -bimodule). By definition the group of n -chains $C_n^S(A)$

is $A \otimes_S A \otimes_S A \dots A \otimes_S A$ ($n + 1$ factors A), which means $A^{\otimes_S n+1}$ factored by the relation $(a_0, \dots, a_n s) = (s a_0, \dots, a_n)$ for any $s \in S$ and $a_i \in A$ (this explains the presence of the last \otimes_S). For instance $A \otimes_S A = A/[A, S]$.

Remark that if $S = k$ is commutative and central, then $C_n^S(A) = C_n(A)$. It is straightforward to check that the Hochschild boundary map b is compatible with this equivalence relation so that there is a well-defined complex $(C_n^S(A), b)$. Its n th homology group is denoted $HH_n^S(A)$. It is sometimes called relative Hochschild homology, but we will not use this terminology here since it conflicts with 1.1.16.

1.2.12 Separable Algebras. By definition a unital k -algebra S is said to be *separable* over k if the S -bimodule map $\mu : S \otimes S^{\text{op}} \rightarrow S$ splits. This is equivalent to the existence of an idempotent $e = \sum u_i \otimes v_i \in S \otimes S^{\text{op}}$ such that $\sum u_i v_i = 1$ and $(s \otimes 1)e = (1 \otimes s)e$ for any $s \in S$ (e is the image of 1 under the splitting map). Examples of separable algebras are: the algebra of $r \times r$ -matrices, the group algebra $k[G]$ where G is a finite group whose order is invertible in k , a simple algebra over a field k whose center is a separable extension of k .

The following is a slight generalization of theorem 1.2.4.

1.2.13 Theorem. *Let S be separable over k . Then for any unital S -algebra A there is a canonical isomorphism*

$$HH_n(A) \cong HH_n^S(A).$$

Proof. (Sketch). There is an obvious canonical epimorphism $\phi : C_*(A) \rightarrow C_*^S(A)$.

Using the idempotent e one can construct a splitting ψ of ϕ and also a homotopy from $\psi \circ \phi$ to id as in the proof of 1.2.4:

$$\psi(a_0, \dots, a_n) = \sum_{i,j,l,\dots,m} v_i a_0 u_j \otimes v_j a_1 u_l \otimes \dots \otimes v_m a_n u_i. \quad \square$$

1.2.14 Corollary. *Let S be separable over k and A be a k -algebra. If, moreover, S is flat over k , then $HH_*(S \otimes A) \cong HH_*(A) \otimes S/[S, S]$.*

Proof. It is easily checked that $C_*^S(S \otimes A) \cong C_*(A) \otimes S/[S, S]$. Therefore theorem 1.2.13 yields

$$HH_*(S \otimes A) \cong HH_*^S(S \otimes A) \cong HH_*(A) \otimes S/[S, S]. \quad \square$$

This corollary applied to $S = \mathcal{M}_r(k)$ gives essentially the same proof as in 1.2.4.

1.2.15 Theorem. *Let A and A' be unital k -algebras and let M be an A - A' -bimodule. Denote by*

$$T = \begin{bmatrix} A & M \\ 0 & A' \end{bmatrix}$$

the triangular matrix algebra. Then the two canonical projections from T to A and A' induce an isomorphism $HH_(T) \cong HH_*(A) \oplus HH_*(A')$.*

Proof. Let

$$\varepsilon = \begin{bmatrix} id_A & 0 \\ 0 & 0 \end{bmatrix}$$

and

$$\varepsilon' = \begin{bmatrix} 0 & 0 \\ 0 & id_{A'} \end{bmatrix}.$$

Then the algebra $S = k\varepsilon + k\varepsilon'$ is separable over k (take $e = \varepsilon \otimes \varepsilon + \varepsilon' \otimes \varepsilon'$). Let us show that the projection maps induce an isomorphism $\pi : C_*^S(T) \cong C_*(A) \oplus C_*(A')$ on chains. The inclusion maps induce a morphism ι such that $\pi \circ \iota = id$. In fact $\iota \circ \pi = id$ as well, since in $C_*^S(T)$ one has the following identity (with $x_i = \begin{bmatrix} a_i & m_i \\ 0 & a'_i \end{bmatrix}$):

$$\begin{aligned} (x_0, \dots, x_n) &= \left(\varepsilon \begin{bmatrix} a_0 & 0 \\ 0 & 0 \end{bmatrix} + \begin{bmatrix} 0 & m_0 \\ 0 & a'_0 \end{bmatrix} \varepsilon', x_1, \dots, x_n \right) \\ &= \left(\varepsilon \begin{bmatrix} a_0 & 0 \\ 0 & 0 \end{bmatrix}, x_1, \dots, x_n \right) + \left(\begin{bmatrix} 0 & m_0 \\ 0 & a'_0 \end{bmatrix} \varepsilon', x_1, \dots, x_n \right) \\ &= (a_0\varepsilon, x_1, \dots, x_n\varepsilon) + \left(\begin{bmatrix} 0 & m_0 \\ 0 & a'_0 \end{bmatrix}, a'_1\varepsilon', x_2, \dots \right) \\ &= \dots \\ &= (a_0\varepsilon, \dots, a_n\varepsilon) + (a'_0\varepsilon', \dots, a'_n\varepsilon'). \end{aligned}$$

Applying Theorem 1.2.13 gives

$$HH_*(T) \cong HH_*^S(T) \cong HH_*(A) \oplus HH_*(A'). \quad \square$$

Exercises

E.1.2.1. Morita Invariance Revisited.

- Let R be a unital k -algebra and let e be an idempotent in R . Suppose that $R = ReR$ and put $S = eRe$. Show that R and S are Morita equivalent (e.g. $R = \mathcal{M}_r(A)$ and $S = A$).
- Show that for any pair of Morita equivalent algebras (R, S) , there exists an integer $r > 0$ and an idempotent $e \in \mathcal{M}_r(R)$ such that $e\mathcal{M}_r(R)e \cong S$.
- Suppose now that R is projective over k (e.g. k is a field). Show that the functors $H_n(eRe, e(-))$ form a family of ∂ -functors (in the sense of Cartan-Eilenberg) which agree with $H_n(R, -)$ for $n = 0$. Conclude that they agree for all n .

E.1.2.2. Transitivity of the Trace Map. Let r and s be two positive integers. Show that the composite

$$HH_*(\mathcal{M}_{rs}(A)) = HH_*(\mathcal{M}_r(\mathcal{M}_s(A))) \xrightarrow{\text{Tr}} HH_*(\mathcal{M}_s(A)) \xrightarrow{\text{Tr}} HH_*(A)$$

is the trace map for $rs \times rs$ matrices.

E.1.2.3. Let A be a commutative k -algebra and let α be an invertible finite dimensional matrix with coefficients in A . Then (α^{-1}, α) is a cycle in $C_1(\mathcal{M}(A))$. Show that its class in $HH_1(\mathcal{M}(A)) \cong HH_1(A)$ is the class of $((\det \alpha)^{-1}, \det \alpha)$.

[It is sufficient to prove it for $k = \mathbb{Z}$ and $A = \mathbb{Z}[x_{ij}, \det^{-1}]$ where \det is the determinant of the matrix (x_{ij}) . It is obvious for $n = 1$, then true for diagonal matrices. Finally diagonalize the generic matrix.]

1.3 Derivations, Differential Forms

Derivations and differential forms are very closely related to Hochschild homology and also, as will be seen later, to Hochschild cohomology. We first introduce the algebraic notion of derivation and study the action of inner derivations. This gives rise to a link between the Hochschild boundary and the Chevalley-Eilenberg boundary.

Then the module of Kähler differentials $\Omega_{A|k}^1$ is introduced; it gives rise to the module of n -forms $\Omega_{A|k}^n$. The case of a polynomial algebra is emphasized. We describe two maps which relate Hochschild homology with the module of n -forms and show that, rationally, the last module is a direct factor of the first.

Standing Assumptions. In this section A is a commutative and unital k -algebra and M is a unitary A -module (considered sometimes as a symmetric A -bimodule), except at the very beginning (1.3.1–1.3.5) where A need not be commutative.

1.3.1 Derivations. By definition a *derivation* of A with values in M is a k -linear map $D : A \rightarrow M$ which satisfies the relation

$$(1.3.1.1) \quad D(ab) = a(Db) + (Da)b \quad \text{for all } a, b \in A.$$

The module of all derivations of A in M is denoted $\text{Der}(A, M)$ or simply $\text{Der}(A)$ when $M = A$.

1.3.2 Inner Derivations. Any element $u \in A$ defines a derivation $ad(u)$ called an *inner derivation*:

$$ad(u)(a) = [u, a] = ua - au.$$

This operation is extended to $C_n(A, M)$ by the following formula

$$ad(u)(a_0, \dots, a_n) = \sum_{0 \leq i \leq n} (a_0, \dots, a_{i-1}, [u, a_i], a_{i+1}, \dots, a_n).$$

It is easily checked that $ad(u)$ commutes with the Hochschild boundary.

1.3.3 Proposition. *Let $h(u) : C_n(A, M) \rightarrow C_{n+1}(A, M)$ be the map of degree 1 defined by*

$$h(u)(a_0, \dots, a_n) := \sum_{0 \leq i \leq n} (-1)^i (a_0, \dots, a_i, u, a_{i+1}, \dots, a_n).$$

Then the following equality holds:

$$bh(u) + h(u)b = -ad(u).$$

Consequently $ad(u)_ : H_n(A, M) \rightarrow H_n(A, M)$ is the zero map.*

Proof. Let $h_i(a_0, \dots, a_n) := (a_0, \dots, a_i, u, a_{i+1}, \dots, a_n)$, and so $h(u) = \sum_{0 \leq i \leq n} (-1)^i h_i$. These maps h_i satisfy the relations (1.0.8) of a presimplicial homotopy except that $d_i h_i - d_i h_{i-1}$ is not zero but sends (a_0, a_1, \dots, a_n) to $(a_0, a_1, \dots, a_{i-1}, -[u, a_i], a_{i+1}, \dots, a_n)$. Therefore $h(u)b + bh(u) = d_0 h_0 - d_{n+1} h_n + \sum_i (d_i h_i - d_i h_{i-1}) = -ad(u)$ which is the expected formula. The last assertion is a consequence of lemma 1.0.9. \square

1.3.4 The Antisymmetrisation Map ε_n . Let S_n be the symmetric group acting by permutation on the set of indices $\{1, \dots, n\}$. Then by definition the permutation $\sigma \in S_n$ acts (on the left) on $(a_0, \dots, a_n) \in C_n(A, M)$ by

$$(1.3.4.1) \quad \sigma \cdot (a_0, a_1, \dots, a_n) = (a_0, a_{\sigma^{-1}(1)}, a_{\sigma^{-1}(2)}, \dots, a_{\sigma^{-1}(n)}).$$

Extending this action by linearity gives an action of the group algebra $k[S_n]$ on $C_n(A, M)$. By definition the *antisymmetrization element* ε_n is

$$\varepsilon_n := \sum_{\sigma \in S_n} \text{sgn}(\sigma) \sigma \in k[S_n].$$

We still denote by ε_n its action on $C_n(A, M)$. By definition the *antisymmetrization map*

$$\varepsilon_n : M \otimes \Lambda^n A \rightarrow C_n(A, M)$$

sends the element $a_0 \otimes a_1 \wedge \dots \wedge a_n$ to $\varepsilon_n(a_0, \dots, a_n)$.

In order to understand the behavior of the *antisymmetrization map* with respect to the Hochschild boundary we need to introduce the *Chevalley-Eilenberg map* $\delta : M \otimes \Lambda^n A \rightarrow M \otimes \Lambda^{n-1} A$ which is classically given by the following formula

(1.3.4.2)

$$\begin{aligned} \delta(a_0 \otimes a_1 \wedge \dots \wedge a_n) &:= \sum_{i=1}^n (-1)^i [a_0, a_i] \otimes a_1 \wedge \dots \wedge \widehat{a}_i \wedge \dots \wedge a_n \\ &+ \sum_{1 \leq i < j \leq n} (-1)^{i+j-1} a_0 \otimes [a_i, a_j] \wedge a_1 \wedge \dots \wedge \widehat{a}_i \wedge \dots \wedge \widehat{a}_j \wedge \dots \wedge a_n. \end{aligned}$$

Remark that this map uses only the Lie algebra structure of A (deduced from its associative algebra structure) and the Lie module structure of M (cf. Chap. 10).

1.3.5 Proposition. *For any k -algebra A and any A -bimodule M the following square is commutative*

$$\begin{array}{ccc} M \otimes \Lambda^n A & \xrightarrow{\varepsilon_n} & C_n(A, M) \\ \delta \downarrow & & \downarrow b \\ M \otimes \Lambda^{n-1} A & \xrightarrow{\varepsilon_{n-1}} & C_{n-1}(A, M). \end{array}$$

In particular if A is commutative and M symmetric then $b \circ \varepsilon_n = 0$.

Proof. The proof is done by induction on n . For $n = 0$ there is nothing to prove. For $n = 1$, $\varepsilon_1 = id$ and $b(a_0, a_1) = a_0 a_1 - a_1 a_0$. On the other hand $\varepsilon_0 = id$ and $\delta(a_0, a_1) = [a_0, a_1] = a_0 a_1 - a_1 a_0$, so $b\varepsilon_1 = \varepsilon_0 \delta$.

Suppose now that $b\varepsilon_n = \varepsilon_{n-1} \delta$. Put $\underline{a} = (a_0, \dots, a_n)$ and for any y in A put $(\underline{a}, y) = (a_0, \dots, a_n, y)$. We first remark that, with this notation and the notation of Proposition 1.3.3, we have the relation

$$(1.3.5.1) \quad \varepsilon_{n+1}(\underline{a}, y) = (-1)^n h(y) \varepsilon_n(\underline{a}).$$

One gets

$$\begin{aligned} b\varepsilon_{n+1}(\underline{a}, y) &= (-1)^n b h(y) \varepsilon_n(\underline{a}) && \text{by (1.3.5.1),} \\ &= (-1)^n (-ad(y) - h(y)b) \varepsilon_n(\underline{a}) && \text{by 1.3.3,} \\ &= (-1)^{n+1} ad(y) \varepsilon_n(\underline{a}) + (-1)^{n-1} h(y) \varepsilon_{n-1} \delta(\underline{a}) && \text{by induction,} \\ &= (-1)^{n+1} ad(y) \varepsilon_n(\underline{a}) + \varepsilon_n(\delta(\underline{a}), y) && \text{by (1.3.5.1),} \\ &= \varepsilon_n \delta(\underline{a}, y). \end{aligned}$$

If A is commutative and M symmetric then $\delta = 0$, whence the second assertion of the proposition. □

1.3.6 Other Examples of Derivations. Let $k = \mathbb{R}$ and let $U \subset \mathbb{R}^n$ be a non-empty open set. The algebra of C^∞ -functions $f : U \rightarrow \mathbb{R}$ is denoted $C^\infty(U)$. For each i the partial differential operator $\partial/\partial x_i : C^\infty(U) \rightarrow C^\infty(U)$, $f \mapsto \partial f/\partial x_i$ is a derivation of $C^\infty(U)$ with values in the same algebra.

Similarly let $A = k[x_1, \dots, x_n]$ be the polynomial algebra on n variables. The algebraic partial differential operator $\partial/\partial x_i$ is determined by

$(\partial/\partial x_i)(x_j) = \delta_{ij}$ (= Kronecker symbol) and the rule (1.3.1.1). Let dx_1, \dots, dx_n be a set of indeterminates and let $M = kdx_1 \oplus \dots \oplus kdx_n$ be a free k -module. Then the map $d : A \rightarrow M$, $da := (\partial a/\partial x_1)dx_1 \oplus \dots \oplus (\partial a/\partial x_n)dx_n$ is a derivation of A (da is called the *formal derivation of a* in this case).

Let $A = \bigoplus_{n \in \mathbb{Z}} A_n$ be a commutative graded algebra. Define $da_n = n a_n$ for a homogeneous element $a_n \in A_n$ and extend d by linearity. Then d is a derivation (sometimes called the *Euler derivation*).

1.3.7 Universal Derivation. The derivation $d : A \rightarrow M$ is said to be *universal* if for any other derivation $\delta : A \rightarrow N$ there is a unique A -linear map $\phi : M \rightarrow N$ such that $\delta = \phi \circ d$. It is constructed as follows. Let I be the kernel of the multiplication $\mu : A \otimes A \rightarrow A$. The algebra $A \otimes A$ (and hence I) is an A -bimodule for the multiplication on the left factor and on the right factor. Let us show that the A -bimodule I/I^2 is symmetric, i.e. the two A -module structures agree. As an A -module, I is generated by the elements $1 \otimes x - x \otimes 1$, $x \in A$. The difference $a(1 \otimes x - x \otimes 1) - (1 \otimes x - x \otimes 1)a = (a \otimes x - ax \otimes 1) - (1 \otimes xa - x \otimes a)$ is equal to $(1 \otimes a - a \otimes 1)(1 \otimes x - x \otimes 1)$, which is in I^2 .

The map $d : A \rightarrow I/I^2$, $dx = \text{class of } (1 \otimes x - x \otimes 1)$ is obviously a derivation. It is universal since for any derivation $\delta : A \rightarrow N$, there is a unique map $\phi = I/I^2 \rightarrow N$ such that $\delta = \phi \circ d$. It is given by $\phi(1 \otimes x - x \otimes 1) = \delta(x)$.

1.3.8 Module of Kähler Differentials. In 1.1.9 we introduced the module of Kähler differentials $\Omega^1_{A|k}$ generated by the elements adb , for $a, b \in A$. It turns out that $d : A \rightarrow \Omega^1_{A|k}$ is the universal derivation. The isomorphism $I/I^2 \cong \Omega^1_{A|k}$ is given by $(1 \otimes x - x \otimes 1) \mapsto dx$.

1.3.9 Proposition. *The canonical A -linear map*

$$\text{Hom}_A(\Omega^1_{A|k}, M) \rightarrow \text{Der}(A, M), \quad f \mapsto f \circ d$$

is an isomorphism. In other words the functor Der is representable and represented by Ω^1 .

Proof. This statement follows from the universality of $\Omega^1_{A|k}$ shown in 1.3.7 and 1.3.8. □

1.3.10 Example: Polynomial Algebra. Let V be a free module over k and let $A = S(V)$ be the symmetric algebra of V . If V is finite dimensional with basis x_1, \dots, x_n , then one gets the polynomial algebra $S(V) = k[x_1, \dots, x_n]$.

Let us prove that there is a canonical isomorphism

$$S(V) \otimes V \cong \Omega^1_{S(V)|k}, \quad a \otimes v \mapsto adv.$$

Any derivation D on $S(V)$ is completely determined by the value of D on V . So the map $S(V) \rightarrow S(V) \otimes V$, $v_1 \dots v_n \mapsto \sum_i v_1 \dots \hat{v}_i \dots v_n \otimes v_i$ is a universal

derivation. Hence by proposition 1.3.9 the $S(V)$ -map $\Omega_{S(V)|k}^1 \rightarrow S(V) \otimes V$ given by $d(v_1 \dots v_n) \mapsto \sum_i v_1 \dots \hat{v}_i \dots v_n \otimes v_i$, an isomorphism.

In particular, as a $k[x_1, \dots, x_n]$ -module, $\Omega_{k[x_1, \dots, x_n]|k}^1$ is generated by dx_1, \dots, dx_n .

1.3.11 The Module $\Omega_{A|k}^n$ of Differential Forms. By convention we put $\Omega_{A|k}^0 = A$. The A -module of *differential n -forms* is, by definition, the exterior product

$$\Omega_{A|k}^n = \Lambda_A^n \Omega_{A|k}^1 .$$

(Note that the exterior product is over A , not k .) It is spanned by the elements $a_0 da_1 \wedge \dots \wedge da_n$, for $a_i \in A$, that we usually write $a_0 da_1 \dots da_n$.

For instance, if $A = S(V)$, then by 1.3.10 there is a canonical isomorphism

$$(1.3.11.1) \quad \Omega_{S(V)|k}^n \cong S(V) \otimes \Lambda^n V .$$

1.3.12 Proposition. *For any commutative k -algebra A and any A -module M the antisymmetrization map induces a canonical map:*

$$\varepsilon_n : M \otimes_A \Omega_{A|k}^n \rightarrow H_n(A, M) .$$

In particular if $M = A$ it gives $\varepsilon_n : \Omega_{A|k}^n \rightarrow HH_n(A)$.

Proof. In the commutative case the map δ of proposition 1.3.5 is 0. Therefore the map $\varepsilon_n : M \otimes \Lambda^n A \rightarrow H_n(A, M)$ is well-defined (take the homology in 1.3.5). In order to show that it factors through $M \otimes \Omega_{A|k}^n$ (where $\Omega_{A|k}^n = \Lambda_A^n(\Omega_{A|k}^1)$) it suffices to show that

$$\begin{aligned} \varepsilon_n(mx, y, a_3, a_4, \dots, a_n) + \varepsilon_n(my, x, a_3, a_4, \dots, a_n) \\ - \varepsilon_n(m, xy, a_3, a_4, \dots, a_n) \end{aligned}$$

is a boundary. For $n = 1$ this element is precisely $b(m, x, y)$. More generally this element is equal to

$$-b \left(\sum_{\sigma} \text{sgn}(\sigma) \sigma. (m, x, y, a_3, a_4, \dots, a_n) \right) ,$$

where the sum is extended over all permutations $\sigma \in S_{n+1}$ verifying $\sigma(1) < \sigma(2)$. □

1.3.13 Remark. The proof of the existence of ε_n , which is given here, is purely combinatorial. There is another one using the shuffle product in Hochschild homology. This will be given in Sect. 4.2.

1.3.14 Lemma. *Let $\pi_n : C_n(A, M) \rightarrow M \otimes_A \Omega_{A|k}^n$ be the surjective map given by $\pi_n(a_0, \dots, a_n) = a_0 da_1 \dots da_n$. Then $\pi_n \circ b = 0$.*

Proof. In the expansion of $\pi_{n-1}b(a_0, \dots, a_n)$ the element $a_0 a_i d a_1 \dots \widehat{d a_i} \dots d a_n$ appears twice: once from $\pi_{n-1} d_{i-1}$ and once from $\pi_{n-1} d_i$. Since the signs in front of it are different, the sum is 0. \square

1.3.15 Proposition. *For any commutative k -algebra A and any A -module M the well-defined map*

$$\pi_n : H_n(A, M) \rightarrow M \otimes_A \Omega_{A|k}^n$$

is functorial in A and M .

In particular if $M = A$ it gives $\pi_n : HH_n(A) \rightarrow \Omega_{A|k}^n$.

Proof. This is an immediate consequence of the previous lemma. \square

The maps π_n and ε_n are related by the following

1.3.16 Proposition. *The composite map $\pi_n \circ \varepsilon_n$ is multiplication by $n!$ on $M \otimes_A \Omega_{A|k}^n$. So, if k contains \mathbb{Q} , then $M \otimes_A \Omega_{A|k}^n$ is a direct summand of $H_n(A, M)$.*

Proof. The equality $\pi_n \circ \varepsilon_n = n!id$ follows from $a_0 d a_{\sigma^{-1}(1)} \dots d a_{\sigma^{-1}(n)} = \text{sgn}(\sigma) a_0 d a_1 \dots d a_n$ for all $\sigma \in S_n$ and $\#S_n = n!$. \square

Exercises

E.1.3.1 Let k be a field and let K be a separable algebraic extension of k . Show that $\Omega_{K|k}^n = 0$, $n \geq 1$. [Show that any derivation is trivial and use 1.3.5.]

E.1.3.2 Let A_S be the commutative algebra A localized at the multiplicative subset S . Show that $\Omega_{A_S|k}^n = \Omega_{A|k}^n \otimes_A A_S = (\Omega_{A|k}^n)_S$.

E.1.3.3 Let k, A and B be commutative rings and let $k \rightarrow A \rightarrow B$ be homomorphisms. Show that there is an exact sequence

$$\Omega_{A|k}^1 \otimes_A B \rightarrow \Omega_{B|k}^1 \rightarrow \Omega_{B|A}^1 \rightarrow 0.$$

Let W be an $A \otimes_k B$ -module. Show that

$$\Omega_{A \otimes B|k}^1 \otimes_{A \otimes B} W = \left(\Omega_{A|k}^1 \otimes_A W \right) \oplus \left(\Omega_{B|k}^1 \otimes_B W \right)$$

and that $\Omega_{A \times B|k}^1 = \Omega_{A|k}^1 \oplus \Omega_{B|k}^1$.

E.1.3.4 Show that $\text{Der}(A, A)$ has a natural Lie algebra structure.

E.1.3.5 Show that $d\alpha = 0$ in $\Omega_{\mathbb{R}|\mathbb{Z}}^1$ is equivalent to: α is algebraic. Show that $\text{Der}_{\mathbb{Z}}(\mathbb{R}, \mathbb{R})$ is nonzero if one assumes the axiom of choice [cf. P. Dehornoy, Un exemple d'élimination de l'axiome du choix, preprint].

1.4 Nonunital Algebras and Excision

In order to understand how Hochschild homology behaves with respect to extensions of k -algebras

$$0 \rightarrow I \rightarrow A \rightarrow A/I \rightarrow 0$$

we need a definition for Hochschild homology of nonunital algebras since in general the two-sided ideal I has no unit. Though the Hochschild complex makes perfect sense for nonunital algebras its homology is not the right one. It has to be modified by “adding” a complex which is acyclic when A is unital (proposition 1.4.5). The striking point is that the cyclic operator, which is going to play a fundamental role in cyclic homology, comes in naturally. With this definition at hand, one can ask when does the following long exact homology sequence hold:

$$\dots \rightarrow HH_n(I) \rightarrow HH_n(A) \rightarrow HH_n(A/I) \rightarrow HH_{n-1}(I) \rightarrow \dots$$

When this happens for any A , the k -algebra I is said to satisfy *excision*. This property can be translated into the existence of a Mayer-Vietoris exact sequence.

The answer is the following: there is a weaker notion of ‘having a unit’, it is ‘being H -unital’, which means essentially that the bar complex is acyclic (1.4.6). Then the main theorem of this chapter, which is due to M. Wodzicki, asserts that being H -unital and satisfying excision are equivalent properties (1.4.10).

The philosophy is that H -unital algebras behave like unital algebras with respect to homology. For instance one proves that H -unital algebras satisfy Morita invariance (1.4.14).

This section is taken out of Wodzicki [1989].

1.4.0 Homology Functors for Nonunital Algebras. There is a standard way to extend a functor F from unital algebras with values in abelian groups to the category of not necessarily unital algebras (nonunital algebras for short).

Let I be a nonunital k -algebra. One can form a unital k -algebra I_+ as follows. As a k -module $I_+ = k \oplus I$ and the multiplication structure is given by $(\lambda, u)(\mu, v) = (\lambda\mu, \lambda v + u\mu + uv)$. The unit is $(1, 0)$ and it is customary to write $\lambda \cdot 1 + u$ for (λ, u) .

By definition the extension of F to nonunital k -algebras is given by

$$F(I) := \text{Coker}(F(k) \rightarrow F(I_+)) .$$

Note that the map $k \rightarrow I_+$, $\lambda \mapsto (\lambda, 0)$ is unital.

Suppose that F commutes with the product of unital algebras, that is the map $F(A \times A') \rightarrow F(A) \times F(A')$ induced by the two projections is an

isomorphism. Then the two definitions of $F(A)$ (A as a unital algebra and as a nonunital algebra) agree. Indeed there is an isomorphism of unital algebras $A_+ \cong k \times A$, $\lambda \cdot 1 + u \mapsto (\lambda, \lambda \cdot 1_A + u)$ compatible with the inclusions of k which gives

$$\text{Coker}(F(k) \rightarrow F(A_+)) \cong \text{Coker}(F(k) \rightarrow F(k) \times F(A)) = F(A).$$

1.4.1 Hochschild Homology for Nonunital Algebras. Since HH_n is a functor from unital algebras to k -modules one can extend its definition to nonunital algebras as above:

$$HH_n(I) := \text{Coker}(HH_n(k) \rightarrow HH_n(I_+)).$$

Since HH_n commutes with the product (cf. Exercise E.1.1.1), this definition coincides with the usual one when I is unital.

1.4.2 Reduced Hochschild Homology. Suppose that the map $k \rightarrow A$ is injective and let $k[0]$ be the complex consisting in k in degree 0. Then the *reduced Hochschild complex* is defined by the following exact sequence, where $(A \otimes \bar{A}^{\otimes*}, b)$ is the normalized Hochschild complex (cf. 1.1.14),

$$0 \rightarrow k[0] \rightarrow (A \otimes \bar{A}^{\otimes*}, b) \rightarrow (A \otimes \bar{A}^{\otimes*}, b)_{\text{red}} \rightarrow 0.$$

Remark that the reduced Hochschild complex is the same as the normalized Hochschild complex except that the module A in degree 0 is replaced by $\bar{A} = A/k$. The homology of this reduced complex is called *reduced Hochschild homology* and denoted $\overline{HH}_n(A)$. From the above exact sequence one obtains an exact sequence in homology

$$(1.4.2.1) \quad 0 \rightarrow HH_1(A) \rightarrow \overline{HH}_1(A) \rightarrow k \rightarrow HH_0(A) \rightarrow \overline{HH}_0(A) \rightarrow 0,$$

and $\overline{HH}_n(A) = HH_n(A)$ for $n \geq 2$.

Suppose that A is augmented, that is $A = I_+$ and therefore $\bar{A} = I$. Then it is immediate that $\overline{HH}_n(I_+) = HH_n(I)$ with the definition of $HH_n(I)$ given in 1.4.1. On the other hand the Hochschild complex $(C_*(I), b)$ (resp. the bar complex $(C_*(I), b')$) described in 1.1.1 (resp. 1.1.11) is well-defined since it does not use the existence of a unit.

1.4.3 Naive Hochschild Homology and Bar Homology. It will prove useful to introduce the following homology theories. For any k -algebra I (unital or not) let $HH_n^{\text{naiv}}(I) = H_n(C_*(I), b)$ be the “naive” Hochschild homology. If I is unital, then $HH_n^{\text{naiv}}(I) = HH_n(I)$. For any k -module V the complex $(V \otimes C_*(I), 1 \otimes b')$ is denoted $C_*^{\text{bar}}(I; V)$ (or simply $C_*^{\text{bar}}(I)$ if $V = k$) and its homology is $H_*^{\text{bar}}(I; V)$.

1.4.4 Proposition. *For any not necessarily unital k -algebra I there is an exact sequence*

$$\dots \rightarrow HH_n^{\text{naiv}}(I) \rightarrow HH_n(I) \rightarrow H_{n-1}^{\text{bar}}(I) \rightarrow HH_{n-1}^{\text{naiv}}(I) \rightarrow \dots$$

Proof. The group $HH_n(I)$ is the homology of the complex $(I_+ \otimes I^{\otimes*}, b)_{\text{red}}$. For $n > 0$ the chain-module $I_+ \otimes I^{\otimes n}$ is isomorphic to $I^{\otimes n+1} \oplus (k \otimes I^{\otimes n})$. For $n = 0$ it is just I . Let us identify the boundary map on this decomposition. On the component $I^{\otimes n+1}$ it is simply b and the image is in the component $I^{\otimes n}$. For the component $k \otimes I^{\otimes n}$ the image of $(1, a_1, \dots, a_n)$ is

$$(a_1, \dots, a_n) - (1, a_1 a_2, a_3, \dots, a_n) + \dots + (-1)^{n-1} (1, a_1, \dots, a_{n-1} a_n) + (-1)^n (a_n, a_1, \dots, a_{n-1}).$$

This sum can be written as the sum of two terms:

$$(a_1, \dots, a_n) + (-1)^n (a_n, a_1, \dots, a_{n-1})$$

which lies in $I^{\otimes n}$ and

$$-(1, a_1 a_2, a_3, \dots, a_n) + \dots + (-1)^{n-1} (1, a_1, \dots, a_{n-1} a_n)$$

which lies in $k \otimes I^{\otimes n-1}$. Define the operator t on $I^{\otimes n}$ by $t(a_1, \dots, a_n) = (-1)^{n-1} (a_n, a_1, \dots, a_{n-1})$ and identify $k \otimes I^{\otimes n}$ with $I^{\otimes n}$. Then the boundary map $I^{\otimes n+1} \oplus I^{\otimes n} \rightarrow I^{\otimes n} \oplus I^{\otimes n-1}$ takes the matricial form

$$\begin{bmatrix} b & 1-t \\ 0 & -b' \end{bmatrix}$$

So we have the following

1.4.5 Proposition. *The complex $(I_+ \otimes I_+^{\otimes*}, b)_{\text{red}}$ is isomorphic to the total complex of the bicomplex $CC(I)^{\{2\}}$:*

$$\begin{array}{ccc} \dots & & \dots \\ \downarrow & & \downarrow \\ I^{\otimes n+1} & \xleftarrow{1-t} & I^{\otimes n+1} \\ \downarrow b & & \downarrow -b' \\ I^{\otimes n} & \xleftarrow{1-t} & I^{\otimes n} \\ \downarrow b & & \downarrow -b' \\ \dots & & \dots \\ \downarrow b & & \downarrow -b' \\ I & \xleftarrow{1-t} & I. \end{array}$$

□

Therefore Hochschild homology of the nonunital algebra I is the homology of $CC(I)^{\{2\}}$. Since $(C_*(I), b)$ is the first column of this bicomplex and $(C_*(I), -b')$ is the second one, there is an exact sequence of complexes

$$0 \rightarrow (C_*(I), b) \rightarrow Tot\ CC(I)^{\{2\}} \rightarrow (C_*(I), -b')[-1] \rightarrow 0$$

from which proposition 1.4.4 follows by taking the homology.

(1.4.5.1) We already noted that if I has a unit then $(C_*(I), b')$ is acyclic (cf. 1.1.12). So in the unital case naive Hochschild homology coincides with Hochschild homology. However it may happen that this is still the case even if I has no unit, and this justifies the following

1.4.6 Definition (M. Wodzicki). The not necessarily unital k -algebra I is said to be *homologically unital*, or *H -unital* for short, if for any k -module V the bar complex $C_*^{\text{bar}}(I; V) = (V \otimes C_*(I), 1 \otimes b')$ is acyclic with 0 augmentation, i.e. $H_*^{\text{bar}}(I; V) = 0$.

Remark that if I is flat over k , then, by the universal coefficient theorem, it suffices that $(C_*(I), b')$ is acyclic. Of course unital algebras are H -unital (cf. 1.1.12). In fact the existence of a left (or a right) unit suffices to imply H -unitality (cf. Remark following 1.1.12). Here are more examples.

1.4.7 Definition. The k -algebra I is said to have *local units* if for every finite family of elements $a_i \in I$ there is an element $u \in I$ such that $ua_i = a_iu = a_i$ for all i .

For instance if A is unital, then the algebra of matrices $\mathcal{M}(A) = \text{colim}_n \mathcal{M}_n(A)$ has local units but is not unital.

1.4.8 Proposition. *Algebras with local units are H -unital.*

Proof (Sketch). Start with a cycle in the bar complex. Since it involves only a finite number of elements in I , there exists a unit for these elements. It can be used to construct a homotopy (inductively) as in the proof of 1.6.5. \square

1.4.9 The Excision Problem. Let A be a (not necessarily unital) k -algebra and I a two-sided ideal such that $A \rightarrow A/I$ is k -split. Then there exists a natural map from the homology of I to the relative homology of A modulo I (cf. 1.1.16)

$$HH_n(I) \rightarrow HH_n(A, I).$$

The ideal I is said to be *excisive* (or *to satisfy excision*) for Hochschild homology if this natural map is an isomorphism in all such situations. It implies that the following sequence is exact

$$\dots \rightarrow HH_n(I) \rightarrow HH_n(A) \rightarrow HH_n(A/I) \rightarrow HH_{n-1}(I) \rightarrow \dots$$

Similar excision properties can be stated analogously for HH^{naiv} and H^{bar} .

1.4.10 Theorem (Wodzicki's Excision Theorem). *The following are equivalent*

- (a) *I is H -unital,*
- (b) *I is excisive for Hochschild homology.*

Proof. The comparison of the exact sequence of proposition 1.4.4 for I with the similar exact sequence for the pair (A, I) implies that excision for H_*^{bar} and HH_*^{naiv} implies excision for HH_* . We first prove excision for H_*^{bar} . The method of proof is quite interesting and will be used several times in this section. Since the aim is to prove the acyclicity of a certain complex, the point is to show that this complex can be viewed as the total complex of a certain multicomplex. Then it is sufficient to verify that this multicomplex is acyclic in at least one direction.

1.4.11 Proposition. *If I is H -unital, then I is excisive for H_*^{bar} .*

Proof. The point is to prove acyclicity for the complex $L_* = \text{Ker}(C_*^{\text{bar}}(A) \rightarrow C_*^{\text{bar}}(A/I))$. There is defined the following decreasing filtration on L_* :

$$F_p L_n = \text{linear span of } \{(a_1, \dots, a_n) \mid \text{at least } n - p \text{ } a_j\text{'s belong to } I\}.$$

The associated spectral sequence is in the first quadrant and we will show that $E_{pq}^1 = 0$.

In order to compute the complex (E_{pq}^0, d^0) we introduce the following notation. Let $\underline{n} = (n_0, \dots, n_l)$ be an $(l+1)$ -tuple of integers such that $n_0, n_1 \geq 0$ and the others are > 0 . Put $|\underline{n}| = n_0 + \dots + n_l$ and $l(\underline{n}) = l$. For a given \underline{n} let $Y_*(\underline{n})$ denote the total complex of the following multiple complex

$$\left((A/I)^{\otimes |\underline{n}|} \right) [n_0 - |\underline{n}|] \otimes C_*^{\text{bar}}(I)[n_1] \otimes \dots \otimes C_*^{\text{bar}}(I)[n_l].$$

Using the k -splitting $A = I \oplus A/I$ it can be shown that the complex (E_{p*}^0, d^0) is canonically isomorphic to $\oplus Y_*(\underline{n})$ where the sum is extended over all \underline{n} such that $|\underline{n}| = p$ and $l(\underline{n}) \geq 1$ (rearrange the entries).

Let us show how it works on an example. Let $u_i \in I$ and $s_i \in S = A/I$. The element $x = (s_1, u_2, u_3, s_4, u_5, u_6)$ is in $F_2 L_6$ and so defines an element in $F_2 L_6 / F_1 L_6 = E_{24}^0$. It is the image, under the canonical isomorphism, of $y = (s_1, s_4) \otimes (u_2, u_3) \otimes (u_5, u_6)$. The image of x under b' is

$$\begin{aligned} & (s_1 u_2, u_3, s_4, u_5, u_6) - (s_1, u_2 u_3, s_4, u_5, u_6) + (s_1, u_2, u_3 s_4, u_5, u_6) \\ & \quad - (s_1, u_2, u_3, s_4 u_5, u_6) + (s_1, u_2, u_3, s_4, u_5 u_6). \end{aligned}$$

But $(s_1 u_2, u_3, s_4, u_5, u_6)$ (and some of the other terms) is in $F_1 L_5$ and so it has trivial image in $F_2 L_5 / F_1 L_5$. Finally there remains only

$$-(s_1, u_2 u_3, s_4, u_5, u_6) + (s_1, u_2, u_3, s_4, u_5 u_6)$$

whose image under the canonical isomorphism is

$$-(s_1, s_4) \otimes (u_2 u_3) \otimes (u_5, u_6) + (s_1, s_4) \otimes (u_2, u_3) \otimes (u_5 u_6) .$$

This element is precisely $b'(y)$ in the multi-complex.

Since I is H -unital, the complex $Y_*(\underline{n})$ is acyclic for any \underline{n} and so $E_{**}^1 = 0$ as claimed. In conclusion the abutment of the spectral sequence is 0, that is $H_*(L_*) = 0$. \square

We now prove excision for HH^{naiv} .

1.4.12 Proposition. *If $A \rightarrow A/I$ is k -split and if I is H -unital, then I is excisive for HH^{naiv} .*

Proof. As before we identify A with $I \oplus A/I$. The kernel $M_* = \text{Ker}(C_*(A) \rightarrow C_*(A/I))$ carries the following filtration :

$$F_p M_{p+q} = \text{linear span of } \{(a_0, \dots, a_{p+q}) \mid \text{at least } q + 1 \text{ } a_j \text{'s belong to } I\} .$$

The associated spectral sequence is in the first quadrant. It is immediate that $(E_{0*}^0, d_0) = (C_*(I), b)$. For $p > 0$ there is a decomposition

$$E_{p*}^0 = (A/I)^{\otimes p} \otimes C_*^{\text{bar}}(I)[-1] \oplus D_{p*}^0 ,$$

where $D_{pq}^0 = \text{linear span of } \{(a_0, \dots, a_{p+q}) \mid \text{there exists } 0 \leq j < i < p + q \text{ such that } a_i \in A/I, a_j \in I\}$. We will show that $E_{p*}^1 = 0$ for $p > 0$.

Denoting by D_{p*}^1 the homology of (D_{p*}^0, d^0) , it comes

$$(1.4.12.1) \quad E_{p*}^1 = H_{*+1}^{\text{bar}}(I; (A/I)^{\otimes p}) \oplus D_{p*}^1 .$$

In order to compute D_{p*}^1 we introduce a new filtration:

$'F_s D_{p,r+s}^0 = \text{linear span of } \{(a_0, \dots, a_{p+r+s}) \mid \text{there exists } p+s \leq i \leq p+r+s \text{ such that } a_i \in A/I\}$.

The associated spectral sequence converges to $D_{p,r+s}^1$. Its E^0 -term (a graded complex) can be identified with $\oplus I^{\otimes r}[-1] \otimes Y_*(\underline{n})$ where the direct sum is extended over all \underline{n} such that $|\underline{n}| = p, l(\underline{n})$ and $n_{l+1} \geq 1$.

Since I is H -unital, the homology of this direct sum is trivial and hence $D_{**}^1 = 0$.

In 1.4.11 we have proved that $H_*^{\text{bar}}(I) = 0$. An easy generalization of this proof shows that, in fact, $H_*^{\text{bar}}(I; V) = 0$ for any k -module V . In particular $H_*^{\text{bar}}(I; (A/I)^{\otimes p}) = 0$.

Summarizing, from (1.4.12.1) we get

$$E_{p*}^1 = 0 \quad \text{for } p > 0 .$$

In conclusion the edge map $(C_*(I), b) = (E_{0*}^0, d^0) \rightarrow M_*$ induces an isomorphism in homology as wished. \square

1.4.13 End of the Proof of Theorem 1.4.10. As remarked earlier, excision for HH^{naiv} and H^{bar} implies excision for HH .

It remains to show that $b) \Rightarrow a)$. Consider the k -algebra $I \oplus V$ with multiplication given by $(u, v)(u', v') = (uu', 0)$. Then $H_*^{\text{bar}}(I; V)$ is a direct summand of $HH_*(I \oplus V)$. The excision property for I implies that $H_*^{\text{bar}}(I; V) = 0$. □

1.4.14 Theorem (Morita Invariance of Hochschild Homology for Matrices over H -unital Algebras). *Let I be an H -unital k -algebra. Then for any integer r (including $r = \infty$) the algebra of matrices $\mathcal{M}_r(I)$ is H -unital and the maps $\text{tr}_* : HH_*(\mathcal{M}_r(I), \mathcal{M}_r(M)) \rightarrow H_*(I, M)$ and $\text{inc}_* : H_*(I, M) \rightarrow H_*(\mathcal{M}_r(I), \mathcal{M}_r(M))$ are isomorphisms and inverse to each other.*

Proof. Let us first prove that $\mathcal{M}_r(I)$ is H -unital. Put $B = \mathcal{M}_r(k)$ so that $\mathcal{M}_r(I) \cong I \otimes \mathcal{M}_r(k) = I \otimes B$. Let $M = I \otimes (B/k \cdot 1)$ be the module which is embedded in the exact sequence

$$0 \rightarrow I \rightarrow I \otimes B \rightarrow M \rightarrow 0 .$$

For any k -module V the complex $C_*^{\text{bar}}(I \otimes B; V)$ is filtered by

$$F_p C_n^{\text{bar}}(I \otimes B; V) = \text{linear span} \{ (s_1, \dots, s_n; v) \mid \text{at least } q \text{ } s_j \text{'s belong to } I \} .$$

Then there is a natural identification $\text{Gr}_* C_*^{\text{bar}}(I \otimes B; V) = C_*^{\text{bar}}(I \rtimes M; V)$ where, in the semi-direct product $I \rtimes M$, $M^2 = 0$. Counting the number of entries which lie in M gives a decomposition $C_*^{\text{bar}}(I \rtimes M; V) = \bigoplus_{l=0}^{\infty} C_*^{\text{bar}}(l)$. Our aim is to show that the homology of $C_*^{\text{bar}}(l)$ is 0.

Again we filter it by

$$F_p C_n^{\text{bar}}(l) = \text{linear span} \{ (r_1, \dots, r_n; v) \mid r_j \in I \text{ for } j \leq q - l \} .$$

The associated spectral sequence $E_{pq}^k \Rightarrow H_{p+q}(C_*^{\text{bar}}(l))$ can be computed from $E_{pq}^0 = C_*^{\text{bar}}(I; (B/k \cdot 1) \otimes V) \otimes C_{p+l-1}^{\text{bar}}(l-1)[l-1]$, where $C_{p+l-1}^{\text{bar}}(l-1)[l-1]$ is viewed as a trivial complex concentrated in dimension $l-1$.

Since I is H -unital by hypothesis, $C_*^{\text{bar}}(I; (B/k \cdot 1))$ is acyclic and therefore $E_{pq}^1 = 0$. Whence $H_*(C_*^{\text{bar}}(I)) = 0$ and finally $H_*^{\text{bar}}(I \otimes B; V) = 0$, that is $I \otimes B = \mathcal{M}_r(I)$ is H -unital.

We now turn to the proof of the Morita invariance. The morphism of split extensions

$$\begin{array}{ccccccccc} 0 & \longrightarrow & I & \longrightarrow & I_+ & \longrightarrow & k & \longrightarrow & 0 \\ & & \downarrow & & \downarrow & & \downarrow & & \\ 0 & \longrightarrow & \mathcal{M}_r(I) & \longrightarrow & \mathcal{M}_r(I_+) & \longrightarrow & \mathcal{M}_r(k) & \longrightarrow & 0 \end{array}$$

leads to a commutative diagram of exact rows

$$\begin{array}{ccccccccc} 0 & \longrightarrow & HH_*(I) & \longrightarrow & HH_*(I_+) & \longrightarrow & HH_*(k) & \longrightarrow & 0 \\ & & \downarrow & & \downarrow & & \downarrow & & \\ 0 & \longrightarrow & HH_*(\mathcal{M}_r(I)) & \longrightarrow & HH_*(\mathcal{M}_r(I_+)) & \longrightarrow & HH_*(\mathcal{M}_r(k)) & \longrightarrow & 0 \end{array}$$

since I is H -unital (apply theorem 1.4.10). Morita invariance for H -unital algebras follows then from Morita invariance for unital algebras (cf. 1.2.4). The proof for $r = \infty$ follows by taking the inductive limit. \square

Exercises

E.1.4.1. Let $k[\varepsilon]$ be the algebra of dual numbers, that is $\varepsilon^2 = 0$. Let I be the ideal $\varepsilon k[\varepsilon]$. Show that $H_*^{\text{bar}}(I) \neq 0$ (i.e. I is not H -unital).

E.1.4.2. Show that if the nonunital k -algebra I satisfies $I^2 \neq I$ then the Morita invariance for matrices does not hold.

E.1.4.3. Let \mathfrak{g} be a Lie algebra over k . Let $U(\mathfrak{g})$ be its universal enveloping algebra and $I(\mathfrak{g})$ the augmentation ideal. Show that $I(\mathfrak{g})$ is H -unital if and only if $H_n(\mathfrak{g}, k) = 0$ for all $n > 0$ (cf. Chap. 10 for these notions).

E.1.4.4. By definition the *cone* of k is the ring Ck of infinite (countable) dimensional matrices (a_{ij}) , $1 \leq i, j$, having only a finite number of elements in each column and in each row. For any k -algebra A the *cone* of A is $CA = Ck \otimes A$. This algebra contains the algebra of finite dimensional matrices $\mathcal{M}(A)$ as a two-sided ideal. The quotient $SA = CA/\mathcal{M}(A)$ is called the *suspension* of A .

(a) Show that $\mathcal{M}(A)$, CA and SA are H -unital whenever A is H -unital (note that $\mathcal{M}(A)$ is not unital even when A is).

Suppose now that A is unital.

(b) Show that $HH_*(CA) = 0$ and that $HH_*(SA) = HH_{*-1}(A)$.

(c) Let

$$\tau = \begin{bmatrix} 0 & 1 & & & \\ & 0 & 1 & & \\ & & 0 & 1 & \\ & & & \dots & \dots \\ & & & & \dots & \dots \end{bmatrix} \in CA$$

and $\bar{\tau}$ its class in SA . Show that $\bar{\tau}$ is invertible so that $A[x, x^{-1}] \rightarrow SA$, $x \mapsto \bar{\tau}$ is well-defined. Show that the induced homomorphism in Hochschild homology is surjective.

(d) Using the results of Sect. 4.2, show that the product by

$$x \in HH_1(k[x, x^{-1}])$$

defines a map $HH_{n-1}(A) \rightarrow HH_n(A[x, x^{-1}])$ which is inverse to the surjective map described in c) (cf. Connes [C, II Cor. 6], Wodzicki [1989], Feigin-Tsygan [FT]).

E.1.4.5. Mayer-Vietoris sequence for Hochschild homology. Let

$$\begin{array}{ccc} A & \longrightarrow & B \\ \downarrow & & \downarrow f \\ C & \longrightarrow & D \end{array}$$

be a Cartesian square of unital k -algebras with f surjective and k -split. Show that if $\text{Ker } f$ is H -unital, then there is a long exact sequence

$$\dots \rightarrow HH_n(A) \rightarrow HH_n(B) \oplus HH_n(C) \rightarrow HH_n(D) \rightarrow HH_{n-1}(A) \rightarrow \dots$$

E.1.4.6. Show that the excision theorem is true under the hypothesis A and A/I are H -unital (cf. Wodzicki [1989]).

E.1.4.7. Show that theorem 1.2.15 is true under the hypothesis A is H -unital (cf. Wodzicki [1989]).

1.5 Hochschild Cohomology, Cotrace, Duality

In this section we give an account of Hochschild cohomology. It is essentially a translation of the definitions and results of the previous sections in the cohomological framework; therefore we omit most of the proofs. On top of that we treat the pairing between homology and cohomology, which gives the most general definition of the residue homomorphism. The last part is concerned with the case of topological algebras, which is easier to deal with in cohomology and which is important for applications.

Note that the seminal article [C] of Connes is written in this framework.

1.5.1 Definition. Let A be a k -algebra and M an A -bimodule. Hochschild homology was shown to be the homology of the complex $M \otimes_{A^e} C_*^{\text{bar}}(A)$, where $C_*^{\text{bar}}(A)$ is the bar resolution of A (cf. 1.1.11 and 1.1.12). So one defines *Hochschild cohomology* of A with coefficients in M as

$$H^n(A, M) = H_n(\text{Hom}_{A^e}(C_*^{\text{bar}}(A), M)).$$

The coboundary map β' in the Hom-complex is given by

$$\beta'(\phi) = -(-1)^n \phi \circ b'$$

for any cochain ϕ in $\text{Hom}_{A^e}(C_n^{\text{bar}}(A), M)$. Explicitly, such a cochain ϕ is completely determined by a k -linear map $f : A^{\otimes n} \rightarrow M$. The relationship is given by

$$\phi(a_0 [a_1 | \dots | a_n] a_{n+1}) = a_0 f(a_1, \dots, a_n) a_{n+1}.$$

Then the formula for the coboundary map is

(1.5.1.1)

$$\begin{aligned} \beta(f)(a_1, \dots, a_{n+1}) &= a_1 f(a_2, \dots, a_{n+1}) \\ &+ \sum_{0 < i < n+1} (-1)^i f(a_1, \dots, a_i a_{i+1}, \dots, a_{n+1}) \\ &+ (-1)^{n+1} f(a_1, \dots, a_n) a_{n+1}. \end{aligned}$$

(Compare with the map b in the homological framework, cf. 1.1.1). Hence $H^n(A, M)$ is the homology of the complex $(C^n(A, M), \beta)$ where $C^n(A, M) = \text{Hom}_k(A^{\otimes n}, M)$.

The cohomological groups (in fact k -modules) $H^n(A, M)$ are $Z(A)$ -modules where $Z(A)$ is the center of A . In particular if A is commutative, then they are A -modules.

For fixed A , $H^n(A, -)$ is a functor from the category of A -bimodules to the category of k -modules (or $Z(A)$ -modules as wished).

Any k -algebra homomorphism $f : A' \rightarrow A$ defines an A' -module structure on M , denoted f^*M , and a map

$$f^* : H^n(A, M) \rightarrow H^n(A', f^*M) .$$

So $f \mapsto f^*$ is contravariant.

1.5.2 Low-dimensional Computations, Derivations. For $n = 0$, $H^0(A, M)$ is the subgroup of invariants of M ,

$$H^0(A, M) = M^A = \{m \in M \mid am = ma \text{ for any } a \text{ in } A\} .$$

For $n = 1$ a 1-cocycle is a k -module homomorphism $D : A \rightarrow M$ satisfying the identity

$$D(aa') = aD(a') + D(a)a', \text{ for } a \text{ and } a' \in A .$$

Such a map is called a *derivation* (or sometimes a *crossed homomorphism*) from A to M and the k -module of derivations is denoted $\text{Der}(A, M)$ (cf. 1.3.1). It is a coboundary if it has the form $ad_m(a) = [m, a] = ma - am$ for some fixed $m \in M$; ad_m is called an *inner derivation* (or sometimes a *principal crossed homomorphism*). Therefore

$$H^1(A, M) = \text{Der}(A, M) / \{\text{inner derivations}\} .$$

It is sometimes called the group of *outer derivations*. In the particular case $M = A$ the module $H^1(A, A)$ is in fact a Lie algebra with Lie bracket given by $[D, D'] = D \circ D' - D' \circ D$. Indeed it is immediate to check that $[D, D']$ is a derivation and that, if $D' = ad_u$ for some $u \in A$, then $[D, ad_u] = ad_{D(u)}$.

1.5.3 Abelian Extensions of Algebras and H^2 . An abelian extension of A by M

$$(E) \quad 0 \rightarrow M \rightarrow E \rightarrow A \rightarrow 0$$

is an extension of associative k -algebras such that the sequence is split over k (i.e. $E \cong M \oplus A$) and $M^2 = 0$. Then M inherits the structure of an A -bimodule. In fact, if we denote by $s : A \rightarrow E$ the section corresponding to the k -splitting of E , then $a \cdot m \cdot a' = s(a)ms(a')$ (product in E).

Two such extensions (E) and (E') with A and M fixed are said to be equivalent if there exists an algebra morphism $\phi : E \rightarrow E'$ which commutes with id_M and id_A ,

$$\begin{array}{ccccccccc} 0 & \rightarrow & M & \rightarrow & E & \rightarrow & A & \rightarrow & 0 \\ & & & & \parallel & & \downarrow & & \parallel \\ 0 & \rightarrow & M & \rightarrow & E' & \rightarrow & A & \rightarrow & 0 \end{array}$$

For a fixed A -bimodule M one considers the set of equivalence classes of extensions of A by M for which the A -bimodule structure of M is the prescribed one.

Any 2-cocycle $f : A^{\otimes 2} \rightarrow M$ gives rise to such an extension (E) by the following procedure. As a k -module $E = M \oplus A$. The product law is given by $(m_1, a_1)(m_2, a_2) = (m_1a_2 + a_1m_2 + f(a_1, a_2), a_1a_2)$. It is a straightforward computation to check that the cocycle condition for f is equivalent to associativity of the product law. The induced A -bimodule structure of M is obviously the former one.

1.5.4 Theorem. *Let A be a unital k -algebra and M be an A -bimodule. The construction described above yields a canonical bijection*

$$H^2(A, M) \cong \mathcal{E}xt(A, M) .$$

Proof. We only sketch the proof since it is to be found in many textbooks (cf. [CE], [ML], Bourbaki [1980], Brown [1982]).

The trivial 2-cocycle gives rise to the semi-direct product $M \rtimes A$ (i.e. $(m_1, a_1)(m_2, a_2) = (m_1a_2 + a_1m_2, a_1a_2)$). Suppose that the 2-cocycle f is modified by a boundary: $f' = f - \beta(g)$ where g is a 1-chain. Then it can easily be shown that the two extensions (E) and (E') , corresponding respectively to f and f' , are equivalent. The equivalence is given by $E \rightarrow E'$, $(m, a) \mapsto (m + g(a), a)$. This shows that the map from H^2 to $\mathcal{E}xt$ is well-defined.

To prove the bijection one constructs a map the other way as follows.

Starting with a k -split extension (E) one computes the product $(0, a_1)(0, a_2)$ which is of the form $(f(a_1, a_2), a_1a_2)$. Associativity in E shows that f is a 2-cocycle. Two equivalent extensions are related by a map $M \oplus A \rightarrow M \oplus A$ of the form

$$d = \begin{bmatrix} id_M & g \\ 0 & id_A \end{bmatrix} ,$$

where $g : A \rightarrow M$ is a 1-chain. One checks that the difference of the two cocycles is precisely $\beta(g)$, so the map which associates $[f]$ to the class of (E) is well-defined. □

An interpretation of $H^3(A, M)$ is given in Exercise E.1.5.1.

1.5.5 The Particular Case $M = A^*$. Notation. For $M = A$ the groups $H^n(A, A)$ have been extensively studied in the literature because they are related to deformation theory. But one should note that they are *not* functors of A . However if $M = A^* = \text{Hom}_k(A, k)$, then the groups $H^n(A, A^*)$ are indeed functors of A . This case is particularly important for our purpose since it will give rise to cyclic cohomology. The A -bimodule structure of A^* is given by $(afa')(c) = f(a'ca)$, $a, a', c \in A$. The cochains can be described as follows. Any cochain $f \in C^n(A, A^*)$ is equivalent to a k -linear map $F : A^{\otimes n+1} \rightarrow k$, $F(a_0, a_1, \dots, a_n) = f(a_1, \dots, a_n)(a_0)$. With this notation the coboundary of F is precisely $\beta(F) = Fob$ (up to sign), where here b is the classical Hochschild boundary. So finally $C^*(A, A^*) = \text{Hom}(C(A), k)$.

When no confusion can arise we write $C^n(A)$ instead of $C^n(A, A^*)$ and $HH^n(A)$ instead of $H^n(A, A^*)$.

When $A = k$ one has $HH^0(k) = k$ and $HH^n(k) = 0$ for $n > 0$.

It will prove useful later to consider more general A -bimodules of the form $A^* \otimes L$ where L is simply a k -module. Any cochain with values in $A^* \otimes L$ is then equivalent to a map $A^{\otimes n+1} \rightarrow L$.

1.5.6 Cotrace Map and Morita Invariance. The functors $H^*(-, -)$ are Morita invariant in the sense of Sect. 1.2. Let us make this explicit in the case of matrices (with notations of Sect. 1.2). The inclusion maps $A \hookrightarrow \mathcal{M}_r(A)$ and $M \hookrightarrow \mathcal{M}_r(M)$ induce a natural map

$$\text{inc}^* : H^n(\mathcal{M}_r(A), \mathcal{M}_r(M)) \rightarrow H^n(A, M)$$

as follows. For $F : \mathcal{M}_r(A)^{\otimes n} \rightarrow \mathcal{M}_r(M)$ we define $\text{inc}^*(F) : A^{\otimes n} \rightarrow M$ by

$$\text{inc}^*(F)(a_1, \dots, a_n) = F(E_{11}^{a_1}, \dots, E_{11}^{a_n})_{11} \in M,$$

(i.e. the $(1, 1)$ -entry of the image in $\mathcal{M}_r(M)$).

There is defined an explicit map the other way round, called the *cotrace map*, as follows. Let $f \in C^n(A, M)$ and let $\alpha_1, \dots, \alpha_n$ be in $\mathcal{M}_r(A)$. Then $F(\alpha_1, \dots, \alpha_n)$ is a matrix in $\mathcal{M}_r(M)$ whose (i, j) -entry is

$$\sum f((\alpha_1)_{i_1 i_2}, (\alpha_2)_{i_2 i_3}, \dots, (\alpha_n)_{i_n j})$$

where the sum is extended over all possible sets of indices (i_2, i_3, \dots, i_n) . The map of complexes $C^*(A, M) \rightarrow C^*(\mathcal{M}_r(A), \mathcal{M}_r(M))$, $f \mapsto F$ induces the cotrace map

$$\text{cotr} : H^*(A, M) \rightarrow H^*(\mathcal{M}_r(A), \mathcal{M}_r(M)).$$

The cotrace map and inc^* are isomorphisms and inverse to each other.

1.5.7 Normalized Complex. Suppose that A is unital. Then the reduced complex $\overline{C}^*(A, M)$ is the subcomplex of $C^*(A, M)$ made up of the maps f which vanish on elements (a_0, \dots, a_n) such that one of the a_i 's ($i \neq 0$) is 1. The inclusion $\overline{C}^* \hookrightarrow C^*$ is a quasi-isomorphism.

1.5.8 Ext-interpretation. If A is unital and projective over k , then Hochschild cohomology can be interpreted in terms of derived functors (cf. [CE]),

$$H^n(A, M) = \text{Ext}_{A^e}^n(A, M) .$$

1.5.9 Duality. Let M and M' be two A -bimodules. The evaluation of cochains on chains is the map

$$C^n(A, M) \times C_n(A, M') \rightarrow M \otimes_{A^e} M' ,$$

given by

$$(f; (m', a_1, \dots, a_n)) \mapsto f(a_1, \dots, a_n) \otimes m' .$$

Since we tensored over A^e in the module range, it is immediate to check that

$$\langle \beta(f), x \rangle = \langle f, b(x) \rangle , \quad f \in C^n(A, M) , \quad x \in C_{n+1}(A, M') .$$

Therefore, restricted to $\{\text{cocycles}\} \times \{\text{cycles}\}$, the evaluation map induces a pairing (called sometimes the *Kronecker product*)

$$(1.5.9.1) \quad \langle -, - \rangle : H^n(A, M) \otimes H_n(A, M') \rightarrow M \otimes_{A^e} M' .$$

Remark that the tensor product on the left can be taken over the center $Z(A)$. For $n = 0$ this pairing is the surjection map $M \otimes_{Z(A)} M' \rightarrow M \otimes_{A^e} M'$.

For $n = 1$ and A commutative, let D be a derivation of A in M and let (D) be its class in $H^1(A, M)$. Then, for $M' = A$, the pairing

$$\begin{aligned} \langle -, - \rangle : H^1(A, M) \otimes_A \Omega_{A|k}^1 &\rightarrow M_A = H_0(A, M) \quad \text{is given by} \\ (D) \otimes adb &\mapsto aDb . \end{aligned}$$

In the particular case $M = \text{Hom}(P, P)$, where P is a finitely generated projective k -module, the composite

$$\langle -, - \rangle : H^n(A, \text{Hom}(P, P)) \otimes_{Z(A)} HH_n(A) \rightarrow (\text{Hom}(P, P))_A \xrightarrow{\text{Tr}} k$$

is called the *residue homomorphism*. Suppose further that A is commutative and that $P = A/I$ for some ideal I . Setting $[(I/I^2)] = \text{Hom}_P(I/I^2, P)$ one sees that there is a natural map

$$\bigoplus_{n \geq 0} [(I/I^2)]^{\otimes n} \rightarrow H^*(A, \text{Hom}(P, P)) .$$

Combining this map with the residue homomorphism and the antisymmetrization map ε_n (cf. 1.3.4) one gets the *residue symbol*:

$$\bigoplus_{n \geq 0} [(I/I^2)]^{\otimes n} \otimes \Omega_{A|k}^n \rightarrow k .$$

The next two results concern the behavior of the Kronecker product under change of algebras. Let $g : A' \rightarrow A$ be a map of unital k -algebras. It induces g_* in homology and g^* in cohomology. For any $f \in H^n(A, M)$, $g^*(f)$ lies in $H^n(A', M)$ and for any $x' \in HH_n(A')$, $g_*(x')$ lies in $HH_n(A)$.

1.5.10 Proposition. *For any g , f and x' as above there is an adjunction formula*

$$\langle g^*(f), x' \rangle = \langle f, g_*(x') \rangle \in M_A = M_{A'} .$$

Proof. Applying the definition of the Kronecker product one gets

$$\langle g^*(f), x' \rangle = f \circ g^{\otimes n}(x') = f(g_*(x')) = \langle f, g_*(x') \rangle . \quad \square$$

This adjunction formula admits the following variation which allows us to extend the previous proposition to the category (k -**ALG**) described in 1.2.9.

1.5.11 Proposition. (*Trace-cotrace adjunction formula*). *Let A be a unital k -algebra and M an A -bimodule. The trace and cotrace maps are related by the following adjunction formula:*

$$\begin{aligned} \langle \text{cotr}(f), x' \rangle &= \langle f, \text{tr}(x') \rangle \in M_A \\ \text{for } f &\in H^n(A, M) \quad \text{and } x' \in HH_n(\mathcal{M}_r(A)) . \end{aligned}$$

Proof. One first remarks that, a priori, the left-hand side of the formula takes values in $\mathcal{M}_r(M)_{\mathcal{M}_r(A)}$. But this last module is isomorphic to M_A via the (ordinary) trace map.

Let $(\alpha_0, \dots, \alpha_n) \in \mathcal{M}_r(M)^{\otimes n+1}$ and let $F = \text{cotr}(f)$ (cf. 1.5.6). By definition one gets

$$\begin{aligned} \text{cotr}(f)(\alpha_0, \dots, \alpha_n) &= \text{tr}(\alpha_0 F(\alpha_1, \dots, \alpha_n)) \\ &= \sum (\alpha_0)_{i_0 i_1} f((\alpha_1)_{i_1 i_2}, \dots, (\alpha_n)_{i_n i_0}) \\ &= f(\text{tr}(\alpha_0, \dots, \alpha_n)) . \end{aligned} \quad \square$$

1.5.12 Hochschild Cohomology of Topological Algebras. Suppose that k is a topological ring (the main examples for applications are $k = \mathbb{R}$ and \mathbb{C}) and let A be a topological k -algebra (for example: a C^* -algebra). Then we restrict ourselves to *continuous* multilinear maps $f : A \times \dots \times A = A^n \rightarrow k$, that we call continuous (or topological) cochains: $f \in C_{\text{top}}^n(A)$. The coboundary map b is as in (1.5.1.1), and obviously $b(f) \in C_{\text{top}}^{n+1}(A)$. Therefore we get a new complex $C_{\text{top}}^*(A)$ and a family of cohomological groups denoted $HH_{\text{top}}^n(A)$. When it is obvious from the context that one is working with the topological algebras and continuous maps, the subscript ‘top’ is very often removed. More information and applications will be treated in Sect. 6 of Chap. 5.

Remark that it is more difficult to define continuous Hochschild homology as this requires to use a topological version of the tensor product.

Exercises

E.1.5.1 Interpretation of $H^3(A, M)$. A *crossed bimodule* is an exact sequence of k -algebras

$$0 \rightarrow M \rightarrow C \xrightarrow{\phi} B \rightarrow A \rightarrow 0$$

together with a B -bimodule structure on C such that

- the sequence of k -algebras is split as a sequence of k -modules,
- B and A are unital and the surjection preserves the unit,
- $\phi(b \cdot c \cdot b') = b\phi(c)b', c \in C, b, b' \in B,$
- $\phi(c) \cdot c' = cc' = c \cdot \phi(c') \forall c, c' \in C.$

(a) Show that $MC = CM = 0$ (in particular $M^2 = 0$) and that there is a well-defined A -bimodule structure on M .

Fix A and the A -bimodule M . A morphism of crossed bimodules is a commutative diagram

$$\begin{array}{ccccccccc} 0 & \rightarrow & M & \rightarrow & C & \xrightarrow{\phi} & B & \rightarrow & A & \rightarrow & 0 \\ & & & & \parallel & & \gamma \downarrow & & \beta \downarrow & & \parallel \\ 0 & \rightarrow & M & \rightarrow & C' & \xrightarrow{\phi'} & B' & \rightarrow & A & \rightarrow & 0 \end{array}$$

such that γ and β are compatible with the B -module structure of C and the B' -module structure of C' . On the set of crossed bimodules with fixed A and M one puts the equivalence relation generated by the existence of a morphism. The set of equivalence classes is denoted $\mathcal{X}\text{mod}(A, M)$.

(b) Prove that there is a canonical bijection $H^3(A, M) \cong \mathcal{X}\text{mod}(A, M)$.

(To construct the map in direction \rightarrow , take $B = T(A)$, the tensor algebra over A . In the other direction, express the associativity in B to construct a 3-cocycle. Compare with Kassel-Loday [1982] in the framework of Lie algebras.)

E.1.5.2. Lie-bracket on $H^*(A, A)$. For $f \in C^m(A, A)$ and $g \in C^n(A, A)$ one defines “composition at the i th place” to be $f \bar{\circ}_i g \in C^{m+n-1}(A, A)$:

$$\begin{aligned} f \bar{\circ}_i g &(a_1, \dots, a_{m+n-1}) \\ &= f(a_1, \dots, a_{i-1}, g(a_i, \dots, a_{i+n-1}), a_{i+n}, \dots, a_{m+n-1}). \end{aligned}$$

Define

$$f \bar{\circ} g := \sum_{i=1}^m (-1)^{(i-1)(n-1)} f \bar{\circ}_i g \quad \text{and} \quad [f, g] := f \bar{\circ} g - (-1)^{(m-1)(n-1)} g \bar{\circ} f.$$

(a) Show that $\beta(f) = -[f, \mu]$, where $\mu : A \otimes A \rightarrow A$ is the product map and β as in 1.5.1.

(b) Show that the bracket $[-, -]$ induces on $H^*(A, A)[1]$ a structure of graded Lie algebra. Check that on $H^1(A, A) = \text{Der}(A)$ it coincides with the

Lie algebra structure of derivations [see M. Gerstenhaber, The cohomology structure of an associative ring, Ann. Math. 78 (1963) 267–288].

E.1.5.3. Let A be a k -algebra which is projective as a k -module. Show that there is a split exact sequence

$$0 \rightarrow \text{Ext}(HH_{n-1}(A), k) \rightarrow HH^n(A) \rightarrow \text{Hom}(HH_n(A), k) \rightarrow 0 .$$

E.1.5.4. Let A be a commutative k -algebra, and M an A -algebra. Show that there exists a graded product on $H^*(A, M)$. Let D_i , $1 \leq i \leq n$, be derivations of A with values in M , and let $(D_1 D_2 \dots D_n)$ be the product of their homology classes (this is an element of $H^n(A, M)$). Show that

$$\langle (D_1 D_2 \dots D_n), \varepsilon_n(dx_1 \dots dx_n) \rangle = \det([D_i(x_j)]) , \quad x_i \in A ,$$

where \det is the determinant function (cf. Lipman [1987, Cor. 1.10.3]).

1.6 Simplicial Modules

When A has a unit element, the family of modules $C_n(A, M)$, $n \geq 0$, is an example of what is called a simplicial module. A large part of what has been done in the previous sections works out perfectly well for simplicial modules. We give other examples and introduce the notion of shuffles. It is used in the computation of the homology of the product of two simplicial modules. This is the Eilenberg-Zilber theorem. More on simplicial theory is done in Appendix B.

1.6.1 Definition. A *simplicial module* M (or simply M) is a family of k -modules M_n , $n \geq 0$, together with k -homomorphisms

$$\begin{aligned} d_i : M_n &\rightarrow M_{n-1} , & i = 0, \dots, n , & \text{ called } \textit{face maps} \text{ and} \\ s_i : M_n &\rightarrow M_{n+1} , & i = 0, \dots, n , & \text{ called } \textit{degeneracy maps} , \end{aligned}$$

satisfying the following identities:

$$(1.6.1.1) \quad \begin{aligned} d_i d_j &= d_{j-1} d_i \quad \text{for } i < j , \\ s_i s_j &= s_{j+1} s_i \quad \text{for } i \leq j , \\ d_i s_j &= \begin{cases} s_{j-1} d_i & \text{for } i < j \\ id_M & \text{for } i = j , \quad i = j + 1 , \\ s_j d_{i-1} & \text{for } i > j + 1 . \end{cases} \end{aligned}$$

A morphism of simplicial modules $f : M \rightarrow M'$ is a family of k -linear maps $f_n : M_n \rightarrow M'_n$ which commute with faces and degeneracies: $f_{n-1} d_i = d_i f_n$ and $f_{n+1} s_i = s_i f_n$ for all i and all n .

A paradigm for simplicial modules is given by $M_n = L \otimes A^{\otimes n}$ where L is an A -bimodule (the particular case $L = A$ gives $M_n = A^{\otimes n+1}$) and the formulas:

$$(1.6.1.2) \quad \begin{aligned} d_i(a_0, \dots, a_n) &= (a_0, \dots, a_i a_{i+1}, \dots, a_n) \quad \text{for } i = 0, \dots, n-1, \\ d_n(a_0, \dots, a_n) &= (a_n a_0, a_1, \dots, a_{n-1}), \\ s_j(a_0, \dots, a_n) &= (a_0, \dots, a_j, 1, a_{j+1}, \dots, a_n) \quad \text{for } j = 0, \dots, n, \end{aligned}$$

where $a_0 \in L$ and $a_i \in A$ for $i = 1, \dots, n$. This simplicial module is denoted $C(A, L)$ or simply $C(A)$ when $L = A$.

One observes that $1 \in A$ is used only in the definition of the degeneracy maps. If we ignore the degeneracies, then M is called a *presimplicial module* (cf. 1.0.6).

From the relations $d_i d_j = d_{j-1} d_i$ it is immediate (cf. 1.0.7) that the simplicial module M gives rise to a chain complex (M_*, d) where

$$d = \sum_{i=0}^n (-1)^i d_i.$$

It will be referred to as the *canonical chain complex* associated to the simplicial module.

1.6.2 Definition. The *homology of the simplicial module* M is

$$H_n(M) := H_n(M_*, d)$$

1.6.3 Examples. (a) Let X be a set and put $M_n = X^{n+1}$ (cartesian product of $n + 1$ copies of X) where X is a set. The formulas

$$d_i(x_0, \dots, x_n) = (x_0, \dots, \hat{x}_i, \dots, x_n), \quad i = 0, \dots, n,$$

where \hat{x}_i means x_i deleted, and

$$s_j(x_0, \dots, x_n) = (x_0, \dots, x_{j-1}, x_j, x_j, x_{j+1}, \dots, x_n), \quad j = 0, \dots, n;$$

put on M the structure of a simplicial set (cf. Appendix B).

Let $k[X^{n+1}]$ be the free k -module over X^{n+1} . Then $n \mapsto k[X^{n+1}]$ is a simplicial module (extend d_i and s_j linearly).

(b) Let G be a group and put $Z_n = G^{n+1}$. There is another simplicial structure on Z which takes care of the group law. It is given by

$$\begin{aligned} d_i(g_0, \dots, g_n) &= (g_0, \dots, g_i g_{i+1}, \dots, g_n) \quad i = 0, \dots, n-1, \\ d_n(g_0, \dots, g_n) &= (g_n g_0, g_1, \dots, g_{n-1}), \\ s_j(g_0, \dots, g_n) &= (g_0, \dots, g_j, 1, g_{j+1}, \dots, g_n), \quad j = 0, \dots, n. \end{aligned}$$

The associated simplicial module $[n] \mapsto k[G^{n+1}]$ is obviously $[n] \mapsto A^{\otimes n+1}$ where A is the group algebra $k[G]$.

(c) Let $Y_n = \{(g_0, \dots, g_n) \in G^{n+1} | g_0 \dots g_n = 1\}$. It is immediate to verify that Y is a subsimplicial set of Z defined above. In fact Y is the nerve of the discrete group G (cf. Appendix B.12).

1.6.4 Normalization. Let M be a simplicial module and let D_n be the submodule of M_n spanned by the degenerate elements, i.e. $D_n = s_0 M_{n-1} + \dots + s_{n-1} M_{n-1}$. The relations between faces and degeneracies (1.6.1.1) show that D_* is a subcomplex of M_* . We will show that this subcomplex does not contribute to the homology of M_* , in other words M_* and its *normalized complex* M_*/D_* have the same homology.

1.6.5 Proposition. *The canonical projection map $M_* \rightarrow M_*/D_*$ onto the normalized complex is a quasi-isomorphism.*

Proof. It suffices to prove that D_* is acyclic. Consider the following filtration of D_n :

$$F_p D_n = \{\text{linear span of } s_0, \dots, s_p : M_{n-1} \rightarrow D_n\} .$$

This filtration satisfies $F_{n-1} D_n = F_n D_n = \dots = D_n$. It determines a spectral sequence whose E^1 -term is the homology of $Gr_* D_*$. Since the abutment of this spectral sequence is the homology of D_* , by appendix D.8 the proposition is an immediate consequence of the following

1.6.6 Lemma. *For any p the complex $Gr_p D_*$ is acyclic.*

Proof. For $n \leq p$, $Gr_p D_n = 0$. So it suffices to prove that, for $n > p$, $(-1)^p s_p$ induces a chain homotopy from id to 0, that is

$$(ds_p + s_p d) \equiv (-1)^p s_p \text{ mod } F_{p-1} .$$

If $i < p$, then $d_i s_p = s_{p-1} d_i$ which is 0 mod F_{p-1} . The middle terms $d_p s_p$ and $d_{p+1} s_p$ cancel with each other. If $i > p+1$, then $d_i s_p = s_p d_{i-1}$, so $d_i s_p s_p$ cancels with $s_p d_{i-1} s_p$ for $p+2 < i \leq n+1$. Hence the only term which is left over in $(ds_p + s_p d) s_p$ is $(-1)^{p+2} d_{p+2} s_p s_p = (-1)^p s_p d_{p+1} s_p = (-1)^p s_p$. \square

There is a simple way to construct a new simplicial module out of a simplicial module: shifting dimensions by one ($N_n = M_{n+1}$) and ignoring part of the structure (that is s_n and d_n). However in a certain sense this new simplicial module is not too interesting because its homology is zero. In fact we will use this fact the other way round, that is to prove that some complexes are acyclic.

1.6.7 Proposition. *Let N be a simplicial module which has an extra degeneracy, that is a map $s_{n+1} : N_n \rightarrow N_{n+1}$ which satisfies formulas (1.6.1.1). Then the complex N_* is endowed with a contracting homotopy, therefore it is acyclic.*

Proof. Formulas (1.6.1.1) for the extra degeneracy are $d_i s_{n+1} = s_n d_i$ if $i \leq n$ and $d_{n+1} s_{n+1} = id$. Therefore we have $ds_{n+1} - s_n d = (-1)^{n+1} id$. Hence $(-1)^n s_n$ is a contracting homotopy from id to 0. \square

1.6.8 Product of Simplicial Modules. Let M and N be two simplicial modules with associated complexes M_* and N_* respectively. The product (in the category of simplicial modules) of M and N is $M \times N$, such that $(M \times N)_n = M_n \otimes N_n$, $d_i(m \otimes n) = d_i(m) \otimes d_i(n)$ and $s_j(m \otimes n) = s_j(m) \otimes s_j(n)$. The Eilenberg-Zilberg theorem (see 1.6.12 below) is a comparison between the complex $(M \times N)_*$ and the tensor product of complexes $M_* \otimes N_*$. In one direction the morphism is given by the Alexander-Whitney map and in the other direction by the shuffle-product map. The particular case of algebras, i.e. $M_n = A^{\otimes n+1}$, is emphasized in Sect. 4.2.

The following notation will be useful. For $x \in M_n$ (or N_n) $\bar{d}(x) = d_n(x)$. So \bar{d} is the “last” face operator. By $(\bar{d})^i$ we mean \bar{d} iterated i times. So, for x in M_n , we have $(\bar{d})^i(x) = d_{n-i+1} \dots d_{n-1} d_n(x)$ for $i > 0$ and $(\bar{d})^0(x) = x$.

1.6.9 Lemma-Definition. *The map $AW : (M \times N)_* \rightarrow M_* \otimes N_*$, given by*

$$AW(a \otimes b) = \sum_{i=0}^n (\bar{d})^{n-i} a \otimes (d_0)^i b, \quad a \in M_n, \quad b \in N_n,$$

is a natural map of complexes called the Alexander-Whitney map.

Proof. Cf. MacLane [ML, Chap. 8, Thm. 8.5]. \square

1.6.10 Shuffles. Let p and q be two non-negative integers. A (p, q) -*shuffle* (μ, ν) is a partition of the set of integers $\{0, \dots, p + q - 1\}$ into two disjoint subsets such that $\mu_1 < \dots < \mu_p$ and $\nu_1 < \dots < \nu_q$. So $\{\mu_1, \dots, \mu_p, \nu_1, \dots, \nu_q\}$ determines a permutation of $\{0, \dots, p + q - 1\}$. By convention $\text{sgn}(\mu, \nu)$ is the sign of this permutation.

1.6.11 Lemma-Definition. *The map $sh : M_* \otimes N_* \rightarrow (M \times N)_*$ given by*

$$sh(a \otimes b) = \sum_{(\mu, \nu)} \text{sgn}(\mu, \nu) (s_{\nu_q} \dots s_{\nu_1}(a) \otimes s_{\mu_p} \dots s_{\mu_1}(b)),$$

for $a \in M_p$ and $b \in M_q$, where (μ, ν) runs over all (p, q) -shuffles, is a natural map of complexes, called the shuffle map. This map is associative and graded commutative.

Proof. Cf. MacLane [ML, Chap. 8, Thm. 8.8]. \square

In this setting graded commutativity means the following. Let $T : M \otimes N \cong N \otimes M$ be the *twisting map* $T(m, n) = (n, m)$. Then one has $T(sh(a, b)) = (-1)^{|a| \cdot |b|} sh(T(a, b))$.

1.6.12 Eilenberg-Zilber Theorem. *The shuffle map and the Alexander-Whitney map are quasi-isomorphisms, which are inverse to each other on homology.*

Proof. Cf. MacLane [ML, Chap. 8, Thm. 8.1] or Cartan-Eilenberg [CE, p. 218, 219]. \square

Exercises

E.1.6.1. Show that on the normalized complexes $AW \circ sh = id$ (cf. MacLane [ML, p. 244]).

E.1.6.2. Let $T : M \otimes N \cong N \otimes M$ and $t : M \times N \cong N \times M$ be the twisting maps. Show that $AW \circ t$ and $T \circ AW$ (resp. $sh \circ T$ and $t \circ sh$) are chain homotopic.

Bibliographical Comments on Chapter 1

Much of the content of this chapter (except Sect. 1.4) is more than thirty years old and can be found in several textbooks, for instance Cartan-Eilenberg [CE], MacLane [ML], Bourbaki [1980]. Originally Hochschild cohomology appeared in Hochschild [1945]. Later on it was recognized that, in the projective case, it is a particular case of the general theory of derived functors. In fact one can also handle the non-projective case through the theory of *relative derived functors* as in Hochschild [1956]. We do not touch this relative theory in this book.

Morita invariance of Hochschild homology seems to be more or less folklore in the matrix case. Proofs under various hypotheses can be found in Connes [C], Lipman [1987], Dennis-Igusa [1982]. The proof of the general case given here, with explicit isomorphisms, is due to McCarthy [1988]. The localization theorem in the non-commutative framework follows from Brylinski [1989]. For the non-flat case, see Geller-Weibel [1991].

Computation of Hochschild homology of triangular matrices (1.2.15) appeared in Kadison [1989] and in Wodzicki [1989]. A particular case was done in Calvo [1988]. See Cibils [1990] for a nice generalization.

The homotopy for an inner derivation (1.3.3) is already in [CE] but has been rediscovered by many people. The comparison of the Chevalley-Eilenberg complex with the Hochschild complex via the antisymmetrization map is due to J.-L. Koszul [1950] (see also [CE]).

The comparison of Hochschild homology with differential forms is studied explicitly in Hochschild-Kostant-Rosenberg [1962]. The use of Hochschild homology as a substitute for differential forms in residue formulas is worked out in detail in Lipman [1987].

Section 4 is entirely due to Wodzicki [1989], who discovered the importance of the notion of H -unitality.

Section 5 is important because several papers in the literature, including Connes' work, are written in this framework. The classification of extensions by H^2 is classical, cf. Hochschild [1945], [CE]. Exercise E.1.5.1 is the analogue of similar results for groups and for Lie algebras, cf. Kassel-Loday [1982]. Hochschild cohomology is an important tool in "Deformation theory", see Gerstenhaber and Schack [1988b].

Simplicial sets were first introduced (under the name semi-simplicial sets) by D.M. Kan. There exist several books or foundational articles on the subject, for instance Gabriel-Zisman [1967], May [1967], Bousfield-Kan [1972]. Shuffles and their fundamental homological properties were introduced by S. Eilenberg and S. MacLane.

Many papers have been devoted to computations of Hochschild homology and cohomology, and only a few of them are listed in the references.

Chapter 2. Cyclic Homology of Algebras

There are at least three ways to construct cyclic homology from Hochschild homology. First, in his search for a non-commutative analogue of de Rham homology theory, A. Connes discovered in 1981 the following striking phenomenon:

- the Hochschild boundary map b is still well-defined when one factors out the module $A \otimes A^{\otimes n} = A^{\otimes n+1}$ by the action of the (signed) cyclic permutation of order $n + 1$.

Hence a new complex was born, whose homology is now called (at least in characteristic zero) *cyclic homology*. As will be seen later (cf. Chap. 10) this is exactly the complex which appears in the computation of the homology of the Lie algebra of matrices (Loday-Quillen and Tsygan).

Second, a slightly different way of looking for a generalization of the de Rham cohomology in the non-commutative framework is to look for a lifting of the differential map d on forms to Hochschild homology. This lifting even exists at the chain level, it is Connes boundary map $B : A^{\otimes n} \rightarrow A^{\otimes n+1}$, whose construction involves the cyclic operator t . From the properties relating b and B one can construct a bicomplex $\mathcal{B}(A)$ whose homology is cyclic homology $HC_*(A)$ (the notation HC stands for “Homologie Cyclique” or for “Homologie de Connes” in French). One should note that the discovery of the lifting B of d was already in a paper by G. Rinehart published in 1963, but apparently forgotten.

It is not at all obvious to relate these two definitions of cyclic homology. The best way to do it is to introduce a third definition which takes advantage of the existence of a periodic resolution of period 2 for the $\mathbb{Z}/(n+1)\mathbb{Z}$ -modules. This gives rise to the so-called cyclic bicomplex $CC(A)$, which

- permits to prove the equivalence, in characteristic zero, of the two previous definitions,
- gives the correct definition of cyclic homology in the characteristic free framework and for not necessarily unital algebras,
- permits us to prove easily the exactness of Connes periodicity exact sequence which relates HH and HC .

In his seminal paper [C] A. Connes was working in the cohomological framework and over the complex number field. In this book we chose to work

instead in the homological framework (under the influence of algebraic K -theory) and over an arbitrary ring k .

Section 2.1 begins with the construction of the cyclic bicomplex $CC(A)$, suggested by the work of B. Tsygan, as done in [LQ]. It takes advantage of the relationship between the simplicial structure of $[n] \mapsto A^{\otimes n+1}$ and the action of the cyclic group. It is proven that HC_n coincides, in characteristic zero, with the original definition of A. Connes denoted H_n^λ as in [C]. In the unital case a suitable modification of $CC(A)$ leads to $\mathcal{B}(A)$ in which, aside from the Hochschild boundary map b , appears the degree +1 differential map B .

Section 2.2 contains the description of the relationship between Hochschild homology and cyclic homology. It takes the form of a long exact sequence (Connes' periodicity exact sequence) :

$$\dots \rightarrow HH_n(A) \xrightarrow{I} HC_n(A) \xrightarrow{S} HC_{n-2}(A) \xrightarrow{B} HH_{n-1}(A) \xrightarrow{I} \dots$$

This shows that, though cyclic homology is not always periodic of period 2, it is endowed with a periodicity map S which plays, in cyclic homology, the role of the Bott periodicity map in topological K -theory. This exact sequence is one of the main tools in the computation of cyclic homology. It is illustrated by the proof of the Morita invariance and the excision property for cyclic homology.

In Sect. 2.3 we compare cyclic homology of a commutative algebra with differential forms and with de Rham cohomology. The correspondence between Connes' boundary map B and the exterior differential operator on forms is the main result of this section.

Section 2.4 is essentially the translation of all the preceding results in the cohomological framework, together with the study of a pairing between cyclic homology and cyclic cohomology.

So far we have concentrated on the case of algebras. However it is easily seen that one can axiomatize the properties of this case to elaborate the notion of a *cyclic module* (and more generally the notion of a *cyclic object* in any category). This generalization will prove to be useful later on, even in the understanding of the algebra case. This is done in Sect. 2.5 and more generally in Chap. 6.

The theory just described is not the only way to extend the notion of differential forms to non-commutative algebras. Section 2.6 describes a different philosophy which is closer to the classical differential calculus (with its notions of connections, curvature and characteristic classes). It consists in working with "non-commutative differential forms" and then abelianizing the corresponding complex before taking the homology. It turns out that the homology groups so obtained are very closely related to cyclic homology.

This chapter follows essentially Loday-Quillen [LQ].

Standing Assumptions. Throughout this chapter k denotes the commutative ground ring and A is an associative algebra over k . The notations

$A^{\otimes n}, b, b'$, etc. are like those in Chap. 1. Note that, when A has no unit, the definition of $HH_n(A)$ involves the b -complex and the b' -complex (cf. 1.4.1 and 1.4.5).

2.1 Definition of Cyclic Homology

First we construct the cyclic bicomplex $CC(A)$ which intertwines the Hochschild complex with the classical 2-periodic resolution coming from the action of the cyclic group $\mathbb{Z}/(n+1)\mathbb{Z}$ on $A^{\otimes n+1}$. Its total homology defines cyclic homology. It is immediate to relate it to the original definition of A. Connes, which is in terms of the quotient of $A^{\otimes n+1}$ by the cyclic group action (Theorem 2.1.5).

A modification of $CC(A)$ gives rise to a new first quadrant bicomplex $\mathcal{B}(A)$ whose vertical differential is b and whose horizontal differential is Connes' boundary map B (cf. 2.1.7). This bicomplex will prove helpful in the comparison with differential forms in Chap. 3.

2.1.0 Cyclic Group Action. The cyclic group $\mathbb{Z}/(n+1)\mathbb{Z}$ action on the module $A^{\otimes n+1}$ is given by letting its generator $t = t_n$ act by

$$t_n(a_0, \dots, a_n) = (-1)^n(a_n, a_0, \dots, a_{n-1})$$

on the generators of $A^{\otimes n+1}$. It is then extended to $A^{\otimes n+1}$ by linearity; it is called the *cyclic operator*. Remark that $(-1)^n$ is the sign of the cyclic permutation on $(n+1)$ letters. Let $N = 1+t+\dots+t^n$ denote the corresponding *norm operator* on $A^{\otimes n+1}$.

2.1.1 Lemma. *The operators t, N, b and b' satisfy the following identities*

$$(1-t)b' = b(1-t), \quad b'N = Nb.$$

Proof. It is immediate to check that

$$(2.1.1.1) \quad d_i t_n = -t_{n-1} d_{i-1} \quad \text{for } 0 < i \leq n \quad \text{and} \quad d_0 t_n = (-1)^n d_n.$$

The first equality can be rewritten $((-1)^i d_i)t = t((-1)^{i-1} d_{i-1})$, from which $(b-d_0)t = tb'$ follows immediately. Then $bt = tb' + (-1)^n d_n$ and therefore $(1-t)b' = b(1-t)$.

The relations (2.1.1.1) imply that

$$\begin{aligned} d_i t^j &= (-1)^j t^j d_{i-j} \quad \text{when } i \geq j, \quad \text{and} \\ d_i t^j &= (-1)^{n-j+1} t^{j-1} d_{n+1+i-j} \quad \text{when } i < j. \end{aligned}$$

Then one can write

$$b'N = \left(\sum_{i=0}^{n-1} (-1)^i d_i \right) \left(\sum_{j=0}^n t^j \right) = \sum_{0 \leq j \leq i \leq n-1} (-1)^{i-j} t^j d_{i-j} + \sum_{0 \leq i < j \leq n} (-1)^{n+1+i-j} t^{j-1} d_{n+1+i-j}.$$

In this summation the coefficient of $(-1)^q d_q$ (for $0 \leq q \leq n$) is

$$\sum_{0 \leq j \leq n-1-q} t^j + \sum_{n-q \leq j-1 \leq n-1} t^{j-1} = N.$$

Therefore we have proved the formula $b'N = Nb$. □

Remark. Note that this lemma is a consequence of the relations (2.1.1.1) alone. In particular the relation $(t_n)^{n+1} = id$ is not used in the proof.

2.1.2 The Cyclic Bicomplex. As an immediate consequence of Lemma 2.1.1, the following is a first quadrant bicomplex denoted $CC(A)$, and called the *cyclic bicomplex*:

$$\begin{array}{ccccccc}
 & \downarrow & & \downarrow & & \downarrow & & \downarrow \\
 A^{\otimes 3} & \xleftarrow{1-t} & A^{\otimes 3} & \xleftarrow{N} & A^{\otimes 3} & \xleftarrow{1-t} & A^{\otimes 3} & \xleftarrow{N} \\
 b \downarrow & & -b' \downarrow & & b \downarrow & & -b' \downarrow & \\
 A^{\otimes 2} & \xleftarrow{1-t} & A^{\otimes 2} & \xleftarrow{N} & A^{\otimes 2} & \xleftarrow{1-t} & A^{\otimes 2} & \xleftarrow{N} \\
 b \downarrow & & -b' \downarrow & & b \downarrow & & -b' \downarrow & \\
 A & \xleftarrow{1-t} & A & \xleftarrow{N} & A & \xleftarrow{1-t} & A & \xleftarrow{N}
 \end{array}$$

By convention the module A , which is in the left-hand corner, is of bidegree $(0, 0)$, so $CC_{pq}(A) = C_q(A) = A^{\otimes q+1}$.

2.1.3 Definition. The *cyclic homology groups* $HC_n(A)$, $n \geq 0$, of the associative (not necessarily unital) k -algebra A are the homology groups of the total complex $\text{Tot } CC(A)$:

$$HC_n(A) := H_n(\text{Tot } CC(A)).$$

Note that we did not assume that A is unital in this definition. A thorough discussion about unitality will be carried out in 2.2.14. As usual

$$HC_*(A) := \bigoplus_{n \geq 0} HC_n(A).$$

We suggest the notation $HC_n(A|k)$ if mentioning k is necessary.

Let $f : A \rightarrow A'$ be a morphism of k -algebras (which need not preserve the unit if any). It induces a morphism of bicomplexes $CC(A) \rightarrow CC(A')$ and therefore a functorial map $HC_n(A) \rightarrow HC_n(A')$.

So HC_n is a functor from the category of associative k -algebras to the category of k -modules. If $k \rightarrow K \rightarrow A$ is a sequence of ring morphisms, there is defined a natural map of k -modules $HC_n(A|k) \rightarrow HC_n(A|K)$.

2.1.4 Connes' Complex. The cokernel $A^{\otimes n+1}/(1-t)$ of the endomorphism $(1-t)$ of $A^{\otimes n+1}$ is the coinvariant space of $A^{\otimes n+1}$ for the action of the cyclic group $\mathbb{Z}/(n+1)\mathbb{Z}$. Following A. Connes we denote it by $C_n^\lambda(A) := A^{\otimes n+1}/(1-t)$. By Lemma 2.1.1 the following is a well-defined complex

$$C_*^\lambda(A) : \dots \xrightarrow{b} C_n^\lambda(A) \xrightarrow{b} C_{n-1}^\lambda(A) \xrightarrow{b} \dots \xrightarrow{b} C_0^\lambda(A)$$

called *Connes complex*, and whose n th homology group is denoted $H_n^\lambda(A)$. The natural surjection $p : \text{Tot } CC(A) \rightarrow C^\lambda(A)$ is the quotient map $A^{\otimes n+1} \rightarrow A^{\otimes n+1}/(1-t)$ on the first column and 0 on the others.

2.1.5 Theorem. *For any algebra A over a ring k which contains \mathbb{Q} the natural map $p_* : HC_*(A) \rightarrow H_*^\lambda(A)$ is an isomorphism.*

Proof. Consider row number n in the bicomplex $CC(A)$. When k contains \mathbb{Q} there is defined a homotopy from id to 0 as follows (cf. Appendix C.4). Let

$$(2.1.5.1) \quad h' := 1/(n+1) \cdot id, \quad h := -(1/(n+1)) \sum_{i=1}^n it^i$$

be maps from $C_n(A)$ to itself. One verifies that

$$(2.1.5.2) \quad h'N + (1-t)h = id, \quad Nh' + h(1-t) = id.$$

Therefore this row is an acyclic augmented complex with $H_0 = C_n^\lambda(A)$.

As a consequence (cf. 1.0.12) the homology of the bicomplex $CC(A)$ is canonically isomorphic to the homology of Connes' complex $C_*^\lambda(A)$. \square

An analogous statement for the reduced Connes' complex $\overline{C}_n^\lambda(A)$ will be proved in 2.2.13.

Remark. By Appendix C.4 the homology of any row in $CC(A)$ is

$$H_* (\mathbb{Z}/(n+1)\mathbb{Z}, A^{\otimes n+1}),$$

i.e. the homology of the discrete group $\mathbb{Z}/(n+1)\mathbb{Z}$ with coefficients in the module $A^{\otimes n+1}$. So the bicomplex $CC(A)$ gives rise to the spectral sequence (cf. Appendix D)

$$E_{pq}^1 = H_p (\mathbb{Z}/(q+1)\mathbb{Z}, A^{\otimes q+1}) \Rightarrow HC_*(A).$$

It shows in particular that the map $HC_i(A) \rightarrow H_i^\lambda(A)$ is an isomorphism for $i \leq n$ provided that $n!$ is invertible in k .

In the proof of 1.1.12 we proved that the b' -complex is contractible when A is unital. So one can expect to simplify the double chain complex $CC(A)$ by getting rid of the contractible complexes (odd degree columns). To do this we use the following easy result.

2.1.6 Lemma (Killing Contractible Complexes). *Let*

$$\dots \rightarrow A_n \oplus A'_n \xrightarrow{d = \begin{bmatrix} \alpha & \beta \\ \gamma & \delta \end{bmatrix}} A_{n-1} \oplus A'_{n-1} \rightarrow \dots$$

be a complex of k -modules such that (A'_, δ) is a complex and is contractible with contracting homotopy $h : A'_n \rightarrow A'_{n+1}$. Then the following inclusion of complexes is a quasi-isomorphism:*

$$(id, -h\gamma) : (A_*, \alpha - \beta h\gamma) \hookrightarrow (A_* \oplus A'_*, d) .$$

Proof. Let us prove that the inclusion $(id, -h\gamma) : A_n \rightarrow A_n \oplus A'_n$ induces a map of complexes $(A_*, \alpha - \beta h\gamma) \rightarrow (A_* \oplus A'_*, d)$.

One one hand we have

$$\begin{bmatrix} \alpha & \beta \\ \gamma & \delta \end{bmatrix} \circ \begin{bmatrix} id \\ -h\gamma \end{bmatrix} = \begin{bmatrix} \alpha - \beta h\gamma \\ \gamma - \delta h\gamma \end{bmatrix} ,$$

and on the other hand

$$\begin{bmatrix} id \\ -h\gamma \end{bmatrix} \circ [\alpha - \beta h\gamma] = \begin{bmatrix} \alpha - \beta h\gamma \\ -h\gamma\alpha + h\gamma\beta h\gamma \end{bmatrix} .$$

From the relations $d^2 = \delta^2 = 0$ one deduces that $\gamma\alpha + \delta\gamma = 0$ and $\gamma\beta = 0$. Hence we only need to show that $\gamma - \delta h\gamma = -h\gamma\alpha$ or equivalently $\gamma = \delta h\gamma - h\gamma\alpha$. Since $\gamma\alpha = -\delta\gamma$ we have $\delta h\gamma - h\gamma\alpha = \delta h\gamma + h\delta\gamma = (\delta h + h\delta)\gamma = \gamma$ because h is a homotopy for δ and we are done.

Since the cokernel of $(id, -h\gamma)$ is isomorphic to (A'_*, δ) , which is acyclic, the inclusion $(id, -h\gamma)$ is a quasi-isomorphism. □

Remark. The case $\gamma = 0$ (resp. $\beta = 0$) is well-known and does not change the differential in A_* .

2.1.7 Connes' Boundary Map B and the Bicomplex $\mathcal{B}(A)$. Now we suppose that A is unital. The first b' -column of $CC(A)$ can be considered as a quotient of $\text{Tot } CC(A)$. Since it is endowed with a contracting homotopy one can apply the 'Killing contractible complexes' lemma. The kernel of this quotient map is deduced from $CC(A)$ as follows: delete the first b' -column and add a map $B : CC_{2q}(A) = A^{\otimes q+1} \rightarrow CC_{0q}(A) = A^{\otimes q+2}$ described as

follows. Sticking to the notation of Lemma 2.1.6 one gets $\alpha = b, \beta = (1 - t), \gamma = N, \delta = -b'$ and $h = -s$ (extra degeneracy). Therefore

$$(2.1.7.1) \quad B = (1 - t)sN .$$

By Proposition 1.1.12 the extra degeneracy is a homotopy for b' , so one can apply Lemma 2.1.6 successively to the odd degree columns of $CC(A)$ to end up with the following diagram

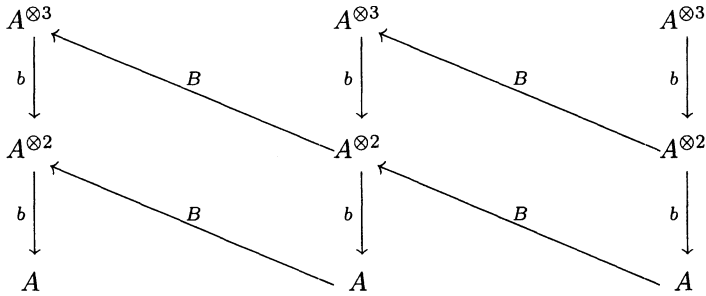

It is customary to rearrange the columns in this diagram (changing the indexing) to get the bicomplex $\mathcal{B}(A)$, where $\mathcal{B}(A)_{pq} = A^{\otimes q-p+1}$ if $q \geq p$ and 0 otherwise:

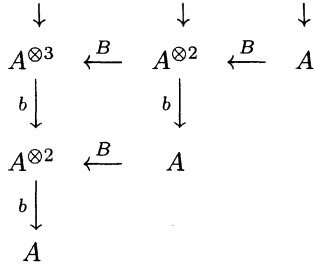

Remark that, as an immediate consequence, we have the formula

$$(2.1.7.2) \quad Bb + bB = 0 .$$

Explicitly $B : A^{\otimes n+1} \rightarrow A^{\otimes n+2}$ is given by

$$\begin{aligned}
 (2.1.7.3) \quad B(a_0, \dots, a_n) &= \sum_{i=0}^n (-1)^{ni} (1, a_i, \dots, a_n, a_0, \dots, a_{i-1}) \\
 &\quad - (-1)^{ni} (a_i, 1, a_{i+1}, \dots, a_n, a_0, \dots, a_{i-1}) .
 \end{aligned}$$

In low dimensions we have

$$B(a_0) = (1, a_0) + (a_0, 1) \quad \text{for } n = 0 ,$$

$$B(a_0, a_1) = ((1, a_0, a_1) - (1, a_1, a_0)) + ((a_0, 1, a_1) - (a_1, 1, a_0)) \quad \text{for } n = 1 .$$

Formula (2.1.7.2) implies that B induces on Hochschild homology a homomorphism denoted

$$(2.1.7.4) \quad B_* : HH_n(A) \rightarrow HH_{n+1}(A).$$

The injective map of complexes $\text{Tot } \mathcal{B}(A) \hookrightarrow \text{Tot } (CC(A))$ sends an element $x \in \mathcal{B}(A)_{pq} = C_{q-p}$ to the element

$$\begin{aligned} x \oplus sN(x) &\in C_{q-p} \oplus C_{q-p+1} \\ &= CC_{2p,q-p} \oplus CC_{2p-1,q-p+1} \subset (\text{Tot } CC(A))_{p+q}. \end{aligned}$$

By Lemma 2.1.6 this map is a quasi-isomorphism and we have proved the following

2.1.8 Theorem ((b, B)-Definition of Cyclic Homology). *For any associative and unital k -algebra A the inclusion map $\text{Tot } \mathcal{B}(A) \rightarrow \text{Tot } CC(A)$ is a quasi-isomorphism and therefore $H_n(\text{Tot } \mathcal{B}(A)) = HC_n(A)$. \square*

Note that the hypothesis, A is unital, is necessary in this statement.

2.1.9 The Bicomplex $\bar{\mathcal{B}}(A)$. The (b, B) -bicomplex $\mathcal{B}(A)$ can be simplified further by replacing the Hochschild complexes by their normalizations (cf. 1.1.15). Let $\bar{A} = A/k$ and consider the new bicomplex $\bar{\mathcal{B}}(A)$:

$$\begin{array}{ccccc} & & \downarrow & & \downarrow & & \downarrow & & \\ & & & \bar{B} & & & \bar{B} & & \\ A \otimes \bar{A}^{\otimes 2} & \xleftarrow{\quad} & A \otimes \bar{A} & \xleftarrow{\quad} & A & & & & \\ & & \downarrow b & & \downarrow b & & & & \\ & & & \bar{B} & & & & & \\ A \otimes \bar{A} & \xleftarrow{\quad} & A & & & & & & \\ & & \downarrow b & & & & & & \\ & & A & & & & & & \end{array}$$

where $\bar{B} = sN : A \otimes \bar{A}^{\otimes n} \rightarrow A \otimes \bar{A}^{\otimes n+1}$ is given by the formula

$$(2.1.9.1) \quad \bar{B}(a_0, \dots, a_n) = \sum_{i=0}^n (-1)^{ni} (1, a_i, \dots, a_n, a_0, \dots, a_{i-1}).$$

(Remark that the sign $(-1)^{ni}$ is exactly the sign of the involved cyclic permutation). In particular

$$\bar{B}(a) = (1, a), \quad \bar{B}(a, a') = (1, a, a') - (1, a', a).$$

If the context is clear we will often write simply B instead of \bar{B} .

By Proposition 1.1.15 the normalization process does not change the homology of the columns. Therefore, by a standard spectral sequence argument (cf. 1.0.12) the surjective map of complexes $\mathcal{B}(A) \rightarrow \bar{\mathcal{B}}(A)$ is a quasi-isomorphism. Thus we have proved the following:

2.1.10 Corollary. *For any unital k -algebra A there is a canonical isomorphism*

$$H_* (\text{Tot } \overline{\mathcal{B}}(A)) \cong HC_*(A) . \quad \square$$

2.1.11 Summary. Finally we have shown that for any k -algebra A there are defined canonical morphisms of complexes

$$\text{Tot } \overline{\mathcal{B}}(A) \leftarrow \text{Tot } \mathcal{B}(A) \hookrightarrow \text{Tot } CC(A) \rightarrow C^\lambda(A) ,$$

the first two being quasi-isomorphisms. The last one is also a quasi-isomorphism when the ground ring k contains \mathbb{Q} .

2.1.12 Elementary Computations. First, if $A = k$, then it is obvious from the $\overline{\mathcal{B}}$ -complex that $HC_{2n}(k) = k$ with generator $1 \in k \cong \overline{\mathcal{B}}(k)_{nn} (n \geq 0)$ and $HC_{2n+1}(k) = 0$.

In the cyclic bicomplex $CC(k)$ the generator of $HC_{2n}(k)$ is the cycle

$$u^n := ((-1)^n(2(n-1))!, \dots, -6, 2, -1, 1) \in (\text{Tot } CC(k))_{2n} ,$$

where $k^{\otimes n}$ is identified with k .

For $H_{2n}^\lambda(k)$ the class of $(1, \dots, 1)$ is a generator. The natural map p sends u^n to $(-1)^n(2(n-1))!(1, \dots, 1)$ for $n > 0$.

So cyclic homology of the ground ring is periodic of period two. This is not true for all k -algebras and the obstruction to being periodic will be analyzed in the next section.

It is also immediate that $HC_0(A) = HH_0(A) = A/[A, A]$. So, if A is commutative, then $HC_0(A) = HH_0(A) = A$.

2.1.13 Remark. Though Hochschild homology groups of A are modules over the center of A , this is not at all true for cyclic homology groups, as it becomes obvious below by looking at $HC_1(A)$.

2.1.14 Proposition. *For any commutative and unital k -algebra A one has*

$$HC_1(A) \cong \Omega_{A|k}^1/dA .$$

Proof. From the complex $\mathcal{B}(A)$ we deduce that the group $HC_1(A)$ is the quotient of $A \otimes A$ by the relations

$$ab \otimes c - a \otimes bc + ca \otimes b = 0 , \quad a, b, c \in A \quad (\text{image of } b) ,$$

$$\text{and } 1 \otimes a - a \otimes 1 = 0 , \quad a \in A \quad (\text{image of } B) .$$

Let us show that the map which sends the class of $a \otimes b$ to $adb \in \Omega_{A|k}^1/dA$ is well-defined. The first relation is a defining relation of $\Omega_{A|k}^1$. The second relation is also fulfilled in $\Omega_{A|k}^1/dA$ because $ad1 = 0$ in $\Omega_{A|k}^1$ and $1da \in dA$. It is an isomorphism because it has an inverse map given by $adb \mapsto a \otimes b$. \square

2.1.15 Relative Cyclic Homology. Let I be a two-sided ideal of A with quotient algebra A/I . Since the map of complexes $CC(A) \rightarrow CC(A/I)$ is surjective one can define $CC(A, I)$ as the kernel. Then $HC_n(A, I)$ is by definition the homology of the complex $\text{Tot } CC(A, I)$. It fits into a long exact sequence

$$(2.1.15.1) \quad \dots \rightarrow HC_n(A, I) \rightarrow HC_n(A) \rightarrow HC_n(A/I) \rightarrow HC_{n-1}(A, I) \rightarrow \dots$$

2.1.16 Change of Ground Ring and Localization. As in Hochschild homology, cyclic homology depends drastically on the ground ring k . If we want to emphasize the choice of k , we write $HC_*(A|k)$ or $HC_*^k(A)$. Let $k \rightarrow K$ be a ring homomorphism (always preserving the unit). Any K -algebra is also a k -algebra. It is immediate that there is defined a canonical map of k -modules

$$HC_*(A|k) \rightarrow HC_*(A|K) .$$

Let S be a multiplicative subset of k and put $K = k_S$ (that is k localized at S) then the above morphism is in fact an isomorphism. In particular if A is a \mathbb{Q} -algebra, then $HC_*(A|\mathbb{Z}) \otimes \mathbb{Q} = HC_*(A|\mathbb{Q})$. These results can be proved either by direct inspection or by using the analogous results for Hochschild homology (cf. 1.1.19) and Connes exact sequence from the next section.

Exercises

E.2.1.1. Let $f_i : A_i \rightarrow A_{i+1}$, $i \in \mathbb{N}$ be an infinite family of k -algebra homomorphisms, whose inductive limit is denoted $\lim_i A_i$. Show that cyclic homology commutes with inductive limits:

$$\lim_i HC_n(A_i) \cong HC_n \left(\lim_i A_i \right) .$$

E.2.1.2. Let I and J be two 2-sided ideals of the unital k -algebra A . Define birelative cyclic homology $HC_*(A; I, J)$ so that there is a long exact sequence

$$\dots \rightarrow HC_n(A, I) \rightarrow HC_n(A/J, (I+J)/J) \rightarrow HC_{n-1}(A; I, J) \rightarrow HC_{n-1}(A, I) \rightarrow \dots .$$

Suppose that $I \cap J = 0$. Show that $HC_0(A; I, J) = 0$ and that $HC_1(A; I, J) = I \otimes_{A^e} J$.

E.2.1.3. Check directly that $HC_1(A) = H_1^\lambda(A)$ (without any characteristic hypothesis). Compute the kernel and the cokernel of the map $HC_2(A) \rightarrow H_2^\lambda(A)$. Find examples for which they are not trivial.

E.2.1.4. Let A^{op} be the opposite algebra of A . Show that there are canonical isomorphisms $HH_n(A) \cong HH_n(A^{op})$ and $HC_n(A) \cong HC_n(A^{op})$. [Use $\omega_n(a_0, \dots, a_n) = (a_0, a_n, a_{n-1}, \dots, a_2, a_1)$.]

2.2 Connes' Exact Sequence, Morita Invariance and Excision

The comparison of cyclic homology with Hochschild homology takes the form of a long exact sequence (2.2.1) involving a “periodicity operator” S . This is Connes' exact sequence which was first discovered by him in the characteristic zero framework. It is an efficient tool to compute cyclic homology from Hochschild homology. It is analogous to the so-called Gysin sequence for the homology of an S^1 -space X (see Appendix D.6), where $H_*(X)$ plays the role of Hochschild homology and $H_*(X/S^1)$ plays the role of cyclic homology. In fact there is more than an analogy and the relationship will be studied extensively in Chap. 7. We study in details the periodicity map S . The following applications are treated: Morita invariance in cyclic homology (2.2.9), computations for triangular matrices (2.2.11), excision properties (2.2.16).

2.2.1 Theorem (Connes' Periodicity Exact Sequence). *For any associative and not necessarily unital k -algebra A there is a natural long exact sequence*

$$\dots \rightarrow HH_n(A) \xrightarrow{I} HC_n(A) \xrightarrow{S} HC_{n-2}(A) \xrightarrow{B} HH_{n-1}(A) \xrightarrow{I} \dots \quad .$$

Proof. Let $CC(A)^{\{2\}}$ be the bicomplex consisting of the first two columns of $CC(A)$. It is clear that the following sequence of bicomplexes is exact

$$0 \rightarrow CC(A)^{\{2\}} \rightarrow CC(A) \rightarrow CC(A)[2, 0] \rightarrow 0 .$$

The notation $[2, 0]$ indicates that degrees are shifted, $(C[2, 0])_{pq} = C_{p-2, q}$.

The expected long exact sequence is the homology sequence associated to the bicomplex sequence. Indeed for unital algebras the b^l -complex is acyclic (cf. 1.1.12) and $CC(A)^{\{2\}}$ is quasi-isomorphic to the Hochschild complex. But more generally the definition of the Hochschild homology of non-unital algebras (cf. 1.4.1) is precisely the homology of $CC(A)^{\{2\}}$ (cf. 1.4.5). \square

The map S is called the *periodicity map*.

2.2.2 Remark. When A is unital Theorem 2.2.1 can be deduced more simply from the bicomplex $\mathcal{B}(A)$ (or equivalently from $\bar{\mathcal{B}}(A)$), by considering the exact sequence of complexes

$$0 \rightarrow C(A) \rightarrow \text{Tot}(\mathcal{B}(A)) \xrightarrow{S} \text{Tot}(\mathcal{B}(A))[2] \rightarrow 0 ,$$

where the first map is the identification of $C(A)$ with the first column of $\mathcal{B}(A)$. Then the periodicity operator S is obtained by factoring out by this first column.

When $A = k$ the map S is an isomorphism which sends the canonical generator $u^n \in HC_{2n}(k)$ to $u^{n-2} \in HC_{2n-2}(k)$, cf. (2.1.12).

In many instances Connes' exact sequence permits us to deduce HC from HH by induction.

2.2.3 Corollary. *Let $f : A \rightarrow A'$ be a k -algebra map (which need not preserve the unit if any). If f induces an isomorphism in Hochschild homology (i.e. for HH_*), then it induces an isomorphism in cyclic homology and conversely.*

Proof. In low dimension Connes' exact sequence takes the form

$$\begin{aligned} \dots \rightarrow HC_1 \rightarrow HH_2 \rightarrow HC_2 \rightarrow HC_0 \rightarrow HH_1 \rightarrow HC_1 \rightarrow 0 \rightarrow HH_0 \\ \rightarrow HC_0 \rightarrow 0, \end{aligned}$$

hence $HH_0 \cong HC_0$ (which we already knew) and therefore $HC_0(A) \cong HC_0(A')$. The k -algebra map f induces a map of bicomplexes $CC(A) \rightarrow CC(A')$ and therefore a commutative diagram

(2.2.3.1)

$$\begin{array}{ccccccc} \dots \rightarrow & HH_n(A) & \xrightarrow{I} & HC_n(A) & \xrightarrow{S} & HC_{n-2}(A) & \xrightarrow{B} & HH_{n-1}(A) & \xrightarrow{I} & \dots \\ & \downarrow & & \downarrow & & \downarrow & & \downarrow & & \\ \dots \rightarrow & HH_n(A') & \xrightarrow{I} & HC_n(A') & \xrightarrow{S} & HC_{n-2}(A') & \xrightarrow{B} & HH_{n-1}(A') & \xrightarrow{I} & \dots \end{array}$$

The isomorphisms for HH_0, HH_1 and HC_0 imply (by the five lemma) an isomorphism for HC_1 . By induction the same procedure yields an isomorphism for HC_n for any $n \geq 0$. The proof in the other direction is similar. \square

2.2.4 Corollary. *For any algebra A over the ring k which contains \mathbb{Q} , there is a natural long exact sequence*

$$\dots \rightarrow HH_n(A) \xrightarrow{I} H_n^\lambda(A) \xrightarrow{S} H_{n-2}^\lambda(A) \xrightarrow{B} HH_{n-1}(A) \xrightarrow{I} \dots$$

Proof. It is a consequence of 2.1.5 and 2.2.1. \square

2.2.5 The Periodicity Map S . It is interesting to make the maps I, S and B explicit in the characteristic zero context. The map I is simply induced by the natural projection $p : A^{\otimes n+1} \rightarrow A^{\otimes n+1}/(1-t) = C_n^\lambda(A)$. The map $B : C_n^\lambda(A) \rightarrow A^{\otimes n+1}$ is as in (2.1.7.3). As for the periodicity map S the computation is a little more elaborate but gives rise to very interesting operators. First some notation is in order:

$$(2.2.5.1) \quad \beta := \sum_{0 \leq i \leq n} (-1)^i d_i : C_n \rightarrow C_{n-1},$$

$$(2.2.5.2) \quad b^{[2]} := \sum_{0 \leq i < j \leq n} (-1)^{i+j} d_i d_j : C_n \rightarrow C_{n-2}.$$

2.2.6 Lemma. *One has $b^{[2]} = [b, \beta] \equiv b\beta + \beta b$ and $[b, b^{[2]}] = 0$.*

Proof. Using the relations $d_i d_j = d_j d_{i+1}$ for $i \geq j$, one shows that

$$\begin{aligned}
 b\beta &= \sum_{0 \leq i < j \leq n} (-1)^{i+j} (j-i) d_i d_j \quad \text{and} \\
 \beta b &= \sum_{0 \leq i < j \leq n} (-1)^{i+j} (i-j+1) d_i d_j
 \end{aligned}$$

from which the first relation follows immediately. The last equality is a consequence of $b^2 = 0$ since

$$[b, b^{[2]}] = bb\beta + b\beta b - b\beta b - \beta b b. \quad \square$$

The relationship between the periodicity map S and $b_*^{[2]}$ is given by the following

2.2.7 Theorem. *Let A be a unital k -algebra, where k contains \mathbb{Q} . Let $x \in C_n(A)$ be such that $p(x) = \bar{x} \in C_n^\lambda(A)$ is a cycle. Then the image of its homology class $[\bar{x}]$ under $S : H_n^\lambda(A) \rightarrow H_{n-2}^\lambda(A)$ is the homology class of $(1/n(n-1))\overline{b^{[2]}(x)} \in C_{n-2}^\lambda(A)$.*

Proof. Since \bar{x} is a cycle there exists an element $\alpha = (x, y, z, \dots) \in C_n \oplus C_{n-1} \oplus C_{n-2} \oplus \dots$ which is a cycle in $\text{Tot } CC(A)$. By construction $S(\alpha) = (z, \dots)$, and its image in $H_{n-2}^\lambda(A)$ is the homology class of $\bar{z} \in C_{n-2}^\lambda$.

$$\begin{array}{ccc}
 x & & \\
 \downarrow & & \\
 -b(x) = (1-t)(y) & \longleftarrow & y \\
 & & \downarrow \\
 & & b'(y) = N(z) \longleftarrow z.
 \end{array}$$

The homotopy (h, h') defined in (2.1.5.1) permits us to choose $y = -hb(x)$ and $z = h'(b'(y)) = -h'b'hb(x)$.

We are interested in the computation of $[\bar{z}]$, hence we can add to z either a boundary (image of b) or any element of the form $(1-t)(u)$, $u \in C_{n-2}$. For instance one can replace $b' = b - (-1)^{n-1}d_{n-1}$ by $(-1)^n d_{n-1}$. Moreover the composite map

$$(-1)^n d_{n-1} h = (-1)^n (-1/n) d_{n-1} \sum_{0 \leq i \leq n-1} it^i$$

can be simplified further by using the relations (2.1.1.1):

$$\begin{aligned} h'b'h &\equiv \frac{1}{n(n-1)} \sum_{i=0}^{n-1} i(-1)^{n-1-i} d_{n-1-i} \\ &\equiv \frac{1}{n(n-1)} \sum_{j=0}^{n-1} (-1)^j j d_j = \frac{1}{n(n-1)} \beta \pmod{(1-t, b)}. \end{aligned}$$

Again, using the fact that one can modify a cycle by adding any boundary, we see that \bar{z} is homologous to $(\beta b + b\beta)(x) = \frac{1}{n(n-1)} b^{[2]}(x)$ in C_{n-2}^λ . \square

We now deal with the Morita invariance of cyclic homology.

2.2.8 Lemma. *The generalized trace map $\text{tr} : \mathcal{M}_r(A)^{\otimes n+1} \rightarrow A^{\otimes n+1}$ (cf. 1.2.1) is compatible with the cyclic action.*

Proof. It suffices to check that $t \circ \text{tr} = \text{tr} \circ t$ on elements of the form $u_0 a_0 \otimes \dots \otimes u_n a_n$ with $u_i \in \mathcal{M}_r(k)$ and $a_i \in A$ for all i . By Lemma 1.2.2 this amounts to verify that $\text{tr}(u_n u_0 \dots u_{n-1}) = \text{tr}(u_0 \dots u_n)$ which is true because k is commutative. \square

2.2.9 Theorem (Morita Invariance for Cyclic Homology). *For any $r \geq 1$ (including $r = \infty$) and any H -unital (e.g. unital) k -algebra A the map $\text{tr}_* : HC_*(\mathcal{M}_r(A)) \rightarrow HC_*(A)$ is an isomorphism, with inverse induced by the inclusion $\text{inc} : A = \mathcal{M}_1(A) \hookrightarrow \mathcal{M}_r(A)$. More generally, if A and A' are Morita equivalent k -algebras, then there is a canonical isomorphism $HC_*(A) \cong HC_*(A')$.*

Proof. We only give the explicit proof for the case of matrices. The general proof is along the same lines (verifying that the maps ϕ and ψ of Theorem 1.2.7 are compatible with the cyclic operator).

By Corollary 1.2.3 and Lemma 2.2.8 the generalized trace map extends to a map of bicomplexes $CC(\mathcal{M}_r(A)) \rightarrow CC(A)$. This map is a quasi-isomorphism on the b -columns (Theorem 1.2.4 for A unital and more generally Theorem 1.4.14 for A H -unital). Let us show that it is also an isomorphism on the b' -columns. It is obvious when A is unital since both complexes are acyclic. When A is H -unital, then $\mathcal{M}_r(A)$ is also H -unital (Theorem 1.4.14) and we are still facing acyclic complexes.

So we have proved that the map of bicomplexes is a quasi-isomorphism, whence the result. \square

2.2.10 Corollary. *For any $r \geq 1$ (including $r = \infty$), the trace map induces an isomorphism $\text{tr}_* : H_n^\lambda(\mathcal{M}_r(A)) \rightarrow H_n^\lambda(A)$ for any unital k -algebra A ($\mathbb{Q} \subset k$). \square*

2.2.11 Functoriality of Cyclic Homology. Let $(k\text{-ALG})$ be the category whose objects are unital k -algebras A and whose morphisms have been defined in 1.2.9. Theorem 2.2.9 implies that HC_n is a functor from $(k\text{-ALG})$ to $(k\text{-Mod})$.

Let A and A' be two k -algebras and let $M = {}_A M_{A'}$ be an A - A' -bimodule which is projective and finite dimensional as A' -module. Denote by M_*^{HH} (resp. M_*^{HC}) the morphism induced by M in Hochschild homology (resp. cyclic homology). Since the maps in Connes' exact sequence are functorial there is a commutative diagram (2.2.3.1) where the vertical maps are either M_*^{HH} or M_*^{HC} . The five lemma applied inductively yields a generalization of Corollary 2.2.3: M_*^{HH} is an isomorphism implies M_*^{HC} is also an isomorphism.

2.2.12 Cyclic Homology of Triangular Matrices. Let A and A' be two k -algebras and M be an A - A' -bimodule. The set of triangular matrices $T = \begin{bmatrix} A & M \\ 0 & A' \end{bmatrix}$ is naturally equipped with a k -algebra structure. Then the two canonical projections from T to A and A' induce an isomorphism in Hochschild homology (cf. 1.2.15), therefore by 2.2.3 they also induce an isomorphism in cyclic homology: $HC_*(T) \cong HC_*(A) \oplus HC_*(A')$.

Before discussing excision in cyclic homology it is necessary to introduce reduced cyclic homology and to clarify some properties of cyclic homology of non-unital algebras.

2.2.13 Reduced Cyclic Homology. Suppose that A is unital and that the homomorphism $k \rightarrow A$ given by the identity is injective. Then reduced cyclic homology $\overline{HC}_*(A)$ is defined as the homology of the bicomplex $\mathcal{B}(A)_{\text{red}}$ given by the exact sequence

$$0 \rightarrow \overline{\mathcal{B}}(k) \rightarrow \overline{\mathcal{B}}(A) \rightarrow \mathcal{B}(A)_{\text{red}} \rightarrow 0 .$$

It follows immediately that the following sequence is exact

$$(2.2.13.1) \quad \dots \rightarrow HC_n(k) \rightarrow HC_n(A) \rightarrow \overline{HC}_n(A) \rightarrow HC_{n-1}(k) \rightarrow \dots .$$

From the definition of reduced Hochschild homology it is also immediate that there is a reduced Connes exact sequence

$$\dots \rightarrow \overline{HH}_n(A) \rightarrow \overline{HC}_n(A) \rightarrow \overline{HC}_{n-2}(A) \rightarrow \overline{HH}_{n-1}(A) \rightarrow \dots .$$

If A is augmented: $A = k \oplus I$, then the exact sequence (2.2.13.1) splits and

$$HC_*(A) = HC_*(k) \oplus \overline{HC}_*(A) .$$

In order to extend Theorem 2.1.5 to reduced cyclic homology one defines $\overline{C}_n^\lambda(A)$ as the quotient of $C_n^\lambda(A)$ by the sub- k -module generated by (a_0, \dots, a_n) such that $a_i = 1$ for at least one index i , $0 \leq i \leq n$. This gives a complex with boundary b , whose homology is denoted $\overline{H}_*^\lambda(A)$.

2.2.14 Proposition. *Assume that k is a direct summand of A as a k -module and that k contains \mathbb{Q} . Then there is a canonical isomorphism*

$$\overline{HC}_*(A) \cong \overline{H}_*^\lambda(A).$$

Proof. Put $\mathcal{B} = \mathcal{B}(A)_{\text{red}}$ and consider the following filtration of \mathcal{B} :

$$F_n \mathcal{B} = \begin{cases} \mathcal{B}_{pq}, & q - p \leq n, \\ k \otimes A^{\otimes n+1}, & q - p = n + 1, \\ 0, & q - p > n + 1. \end{cases}$$

(Recall that $A = k \oplus \overline{A}$ as a k -module.)

Put $\overline{\mathcal{C}} = \overline{\mathcal{C}}^\lambda(A)$ and consider the following filtration of $\overline{\mathcal{C}}$:

$$(F_n \overline{\mathcal{C}})_p = \begin{cases} \overline{\mathcal{C}}_p, & p \leq n, \\ 0, & p > n. \end{cases}$$

The surjection $\phi : \text{Tot } \overline{\mathcal{B}} \rightarrow \overline{\mathcal{C}}$ is compatible with the filtration. So, in order to prove that it is a quasi-isomorphism, it is sufficient to show that it induces an isomorphism on the associated graded modules.

By construction $F_n \mathcal{B}/F_{n-1} \mathcal{B}$ is the bicomplex $\overline{A}^{\otimes n+1}$

$$\begin{array}{ccc} & \overline{A}^{\otimes n+1} & \xleftarrow{N} \overline{A}^{\otimes n+1} \\ & \downarrow 1-t & \\ \overline{A}^{\otimes n+1} & \xleftarrow{N} & \overline{A}^{\otimes n+1} \\ \downarrow 1-t & & \\ \overline{A}^{\otimes n+1} & & \end{array}$$

whose total complex is a resolution of $\overline{\mathcal{C}}_n = F_n \overline{\mathcal{C}}/F_{n-1} \overline{\mathcal{C}}$ (recall that k contains \mathbb{Q}). This shows that ϕ induces an isomorphism at the graded level. \square

2.2.15 Cyclic Homology of Non-unital Algebras Revisited. Cyclic homology was defined in 2.1.2 without any hypothesis on the existence of a unit. On the other hand the general procedure described in 1.4.1 gives a definition for non-unital algebras from the definition for unital algebras. The following shows that these two definitions agree:

2.2.16 Proposition. *For any non-unital k -algebra I , the complexes $CC(I)$ and $\mathcal{B}(I_+)_{\text{red}}$ are canonically isomorphic, hence $HC_*(I) = \overline{HC}_*(I_+)$.*

Proof. This assertion follows almost immediately from the computation made in the proof of Proposition 1.4.5. The only point to check is the compatibility of the decomposition $I^{\otimes n+1} \oplus I^{\otimes n} \cong I_+ \otimes I^{\otimes n}$ with N and B , which follows from:

$$B(1, u_1, \dots, u_n) = 0,$$

$$\begin{aligned}
 B(u_0, \dots, u_n) &= \sum_{i=0}^n (-1)^{in} (1, u_i, \dots, u_n, u_0, \dots, u_{i-1}) \\
 &= 1 \otimes N(u_0, \dots, u_n). \quad \square
 \end{aligned}$$

Remark that there is no difference between “naive” cyclic homology and cyclic homology.

The general problem of excision was posed in 1.4.9. Its solution for cyclic homology is given by the following

2.2.17 Theorem (Excision in Cyclic Homology). *Let $0 \rightarrow I \rightarrow A \rightarrow A/I \rightarrow 0$ be an extension of k -algebras with A and A/I unital. If I is H -unital, then there is a long exact sequence*

$$\dots \rightarrow HC_n(I) \rightarrow HC_n(A) \rightarrow HC_n(A/I) \rightarrow HC_{n-1}(I) \rightarrow \dots$$

Proof. As for Hochschild homology there is a well-defined functorial map

$$HC_n(I) \rightarrow HC_n(A, I).$$

On the other hand, from the construction of $HC_n(I)$ it is immediate that there is a long Connes exact sequence in the framework of non-unital algebras.

Considering the commutative diagram of exact rows (using 2.2.1 and its immediate relative version):

$$\begin{array}{ccccccc}
 \dots \rightarrow & HH_n(I) & \rightarrow & HC_n(I) & \rightarrow & HC_{n-2}(I) & \rightarrow & HH_{n-1}(I) & \rightarrow & \dots \\
 & \downarrow & & \downarrow & & \downarrow & & \downarrow & & \\
 \dots \rightarrow & HH_n(A, I) & \rightarrow & HC_n(A, I) & \rightarrow & HC_{n-2}(A, I) & \rightarrow & HH_{n-1}(A, I) & \rightarrow & \dots
 \end{array}$$

the five lemma and Theorem 1.4.10. (i.e. $HH_n(I) \rightarrow HH_n(A, I)$ is an isomorphism when I is H -unital) imply that $HC_n(I) \rightarrow HC_n(A, I)$ is an isomorphism for all n . The theorem now follows from the exact sequence (2.1.15.1). □

Exercises

E.2.2.1. Let A and A' be two unital k -algebras. Show that there is a canonical isomorphism

$$HC_*(A \times A') \cong HC_*(A) \oplus HC_*(A').$$

E.2.2.2. Show that the following are equivalent (A is unital):

- (a) $k \rightarrow A/[A, A]$ is injective,
- (b) $HC_*(k) \rightarrow HC_*(A)$ is injective.

[Use functoriality of the periodicity map S .]

E.2.2.3. Dual Numbers. Suppose that $A = k \oplus I$ is a ring of dual numbers, that is $uv = 0$ for $u, v \in I$. Show that $\overline{HC}_n(A) = HC_n(I) \cong \bigoplus_{p=0}^n H_{n-p}(\mathbb{Z}/(p+1)\mathbb{Z}, I^{\otimes p+1})$, where the generator of the cyclic group acts by t on $I^{\otimes p+1}$. Deduce that, if k contains \mathbb{Q} , then $HC_n(I) = I^{\otimes n+1}/(1-t)$. (cf. Loday-Quillen [LQ, 4.3]).

E.2.2.4. Let I be a two-sided ideal of A . Show that there is a long exact sequence

$$\dots \rightarrow HH_n(A, I) \rightarrow HC_n(A, I) \rightarrow HC_{n-2}(A, I) \rightarrow HH_{n-1}(A, I) \rightarrow \dots$$

Show the existence of a similar exact sequence in the birelative framework.

E.2.2.5. Show that if I is excisive for cyclic homology, then I is H -unital (cf. Wodzicki [1989]).

E.2.2.6. Let $\beta' = \sum_{0 \leq i \leq n-1} (-1)^i d_i$ and $b'^{[2]} = \sum_{0 \leq i < j \leq n-1} (-1)^{i+j} d_i d_j$. Show that $b'^{[2]} = [\beta', \beta']$ and that

$$b^{[2]}(1-t) = (1-t)b'^{[2]} - 2bb'$$

Deduce from this formula that $b_n^{[2]} : H_n^\lambda(A) \rightarrow H_{n-2}^\lambda(A)$ is well-defined without any hypothesis on the characteristic. Show that $H_{2n}^\lambda(\mathbb{Z}) = \mathbb{Z}$ and that $b_{2n}^{[2]}$ is multiplication by $-n$.

E.2.2.7. Hyper-Boundaries. The hyperboundary $b^{[r]}$ is a degree r map defined by the formula

$$b^{[r]} = \sum_{0 \leq i_1 < \dots < i_r \leq n} (-1)^{i_1 + \dots + i_r} d_{i_1} \dots d_{i_r} : C_n \rightarrow C_{n-r}$$

In particular $b^{[1]} = b$. Show that $(b^{[2]})^p = (p-1)!b^{[2p]}$ and that $b^{[2p+1]} = b^{[2p]}b$. Deduce from these equalities that $b^{[2p+1]}$ is a boundary map (i.e. $b^{[2p+1]}b^{[2p+1]} = 0$). [Use Lemma 2.2.6.]

2.3 Differential Forms, de Rham Cohomology

The comparison of Hochschild homology with differential forms done in Sect. 1.3 gave rise to a natural map $\varepsilon_n : \Omega_{A|k}^n \rightarrow HH_n(A)$. For differential forms there is defined a differential operator $d : \Omega_{A|k}^n \rightarrow \Omega_{A|k}^{n+1}$ and so it is natural to ask for the existence of a map (dotted arrow) which would make the following diagram commutative:

$$\begin{array}{ccc} \Omega_{A|k}^n & \xrightarrow{d} & \Omega_{A|k}^{n+1} \\ \downarrow & & \downarrow \\ HH_n(A) & \longrightarrow & HH_{n+1}(A) \end{array}$$

It turns out that this map exists and is precisely B_* , that is the map induced on Hochschild homology by Connes boundary map B (in fact this lifting was already discovered by Rinehart in 1963). Hence it is not surprising that cyclic homology is strongly related to de Rham cohomology.

In characteristic zero this relationship takes the form of the existence of a natural map:

$$HC_n(A) \rightarrow \Omega_{A|k}^n / d\Omega_{A|k}^{n-1} \oplus H_{DR}^{n-2}(A) \oplus H_{DR}^{n-4}(A) \oplus \dots ,$$

which turns out to be an isomorphism when A is smooth (cf. Sect. 3.4).

Standing Assumption. In this section A is a unital commutative k -algebra.

2.3.1 De Rham Cohomology. Let $\Omega_{A|k}^n$ be the A -module of differential n -forms (cf. 1.3.11). The exterior differential operator $d : \Omega_{A|k}^n \rightarrow \Omega_{A|k}^{n+1}$ is defined by

$$d(a_0 da_1 \dots da_n) := da_0 da_1 \dots da_n .$$

Since $d1 = 0$ it is immediate that $d \circ d = 0$, and the following sequence

$$A = \Omega_{A|k}^0 \xrightarrow{d} \Omega_{A|k}^1 \rightarrow \dots \rightarrow \Omega_{A|k}^n \xrightarrow{d} \Omega_{A|k}^{n+1} \rightarrow \dots$$

is a complex called the *de Rham complex* of A over k . Remark that $(\Omega_{A|k}^*, d)$ is a DG-algebra (cf. Appendix A.8) for the product

$$a_0 da_1 \dots da_n \wedge a'_0 da'_1 \dots da'_m = a_0 a'_0 da_1 \dots da_n da'_1 \dots da'_m .$$

The homology groups of the de Rham complex are denoted $H_{DR}^n(A)$ and are called the *de Rham cohomology groups* of A over k . These groups should really be thought of as cohomology groups of the spectrum $\text{Spec } A$. If we wanted to be coherent with our previous notation we should denote them by $H_{-n}^{DR}(A)$ or $H_{DR}^n(\text{Spec } A)$ since these functors are covariant in A and contravariant in $\text{Spec } A$. We adopt the latter notation, but delete Spec for the sake of simplicity.

2.3.2 Differential Forms and Cyclic Homology. Recall from Sect. 1.3 that for any commutative k -algebra A there exists a functorial map $\pi_n : C_n(A) \rightarrow \Omega_{A|k}^n$ inducing $\pi_n : HH_n(A) \rightarrow \Omega_{A|k}^n$ and there exists the antisymmetrisation map $\varepsilon_n : \Omega_{A|k}^n \rightarrow HH_n(A)$, which satisfy $\pi_n \circ \varepsilon_n = n!id$. The following propositions show that Connes boundary map B and the classical differential operator d on forms are compatible.

2.3.3 Proposition. *For any unital and commutative k -algebra A the following diagram is commutative*

$$\begin{array}{ccc}
 \Omega_{A|k}^n & \xrightarrow{d} & \Omega_{A|k}^{n+1} \\
 \varepsilon_n \downarrow & & \downarrow \varepsilon_{n+1} \\
 HH_n(A) & \xrightarrow{B_*} & HH_{n+1}(A)
 \end{array}$$

Proof. The commutativity of the diagram

$$(2.3.3.1) \quad \begin{array}{ccc}
 A \otimes \Lambda^n(A) & \xrightarrow{d} & A \otimes \Lambda^{n+1}(A) \\
 \varepsilon_n \downarrow & & \downarrow \varepsilon_{n+1} \\
 C_n(A) & \xrightarrow{B} & C_{n+1}(A)
 \end{array}$$

follows from the formula $\varepsilon_n(a_0 da_1 \dots da_n) = \sum_{\sigma \in S_n} \text{sgn}(\sigma) \sigma.(a_0, \dots, a_n)$ and from the fact that B consists in summing over the cyclic group $\mathbb{Z}/(n+1)\mathbb{Z}$. The bijection $S_{n+1} = (\mathbb{Z}/(n+1)\mathbb{Z}) \times S_n$ implies that

$$B \circ \varepsilon_n(a_0 da_1 \dots da_n) = \varepsilon_{n+1}(1, a_0, \dots, a_n) = \varepsilon_{n+1} \circ d(a_0 da_1 \dots da_n).$$

The diagram of 2.3.3 is obtained by taking the homology groups. □

2.3.4 Proposition. *For any unital and commutative k -algebra A the following diagram is commutative*

$$\begin{array}{ccc}
 HH_n(A) & \xrightarrow{B_*} & HH_{n+1}(A) \\
 \pi_n \downarrow & & \downarrow \pi_{n+1} \\
 \Omega_{A|k}^n & \xrightarrow{(n+1)d} & \Omega_{A|k}^{n+1}
 \end{array}$$

Proof. The commutativity of the diagram

$$(2.3.4.1) \quad \begin{array}{ccc}
 C_n(A) & \xrightarrow{B} & C_{n+1}(A) \\
 \pi_n \downarrow & & \downarrow \pi_{n+1} \\
 \Omega_{A|k}^n & \xrightarrow{(n+1)d} & \Omega_{A|k}^{n+1}
 \end{array}$$

is a consequence of the formula

$$\begin{aligned}
 \pi_{n+1} B(a_0, \dots, a_n) &= \sum_{i=0}^n (-1)^{in} da_i \dots da_n da_0 \dots da_{i-1} = \sum_{i=0}^n da_0 \dots da_n \\
 &= (n+1) da_0 \dots da_n = (n+1) d\pi_n(a_0, \dots, a_n).
 \end{aligned}$$

Since π is a morphism of complexes (differential b for $C(A)$ and 0 for $\Omega_{A|k}^*$) the commutativity of the diagram follows by taking the homology groups in (2.3.4.1). □

2.3.5 Corollary. *For any unital and commutative k -algebra A there is a functorial map*

$$\varepsilon_n : \Omega_{A|k}^n / d\Omega_{A|k}^{n-1} \rightarrow HC_n(A)$$

which is split injective when k contains \mathbb{Q} and which makes the following diagram commutative:

$$\begin{array}{ccccccc} \dots \rightarrow & \Omega^{n-1} / d\Omega^{n-2} & \xrightarrow{d} & \Omega^n & \longrightarrow & \Omega^n / d\Omega^{n-1} & \xrightarrow{0} & \Omega^{n-2} / d\Omega^{n-3} & \rightarrow \dots \\ & \downarrow & & \downarrow & & \downarrow & & \downarrow & \\ \dots \rightarrow & HC_{n-1} & \xrightarrow{B} & HH_n & \xrightarrow{I} & HC_n & \xrightarrow{S} & HC_{n-2} & \xrightarrow{B} \dots \end{array}$$

Proof. The map $B_* : HH_{n-1} \rightarrow HH_n$ factors through HC_{n-1} and the composite $I \circ B : HC_{n-1} \rightarrow HC_n$ is zero. Then Proposition 2.3.3 shows that $\text{coker}(d)$ maps canonically to HC_n .

When k contains \mathbb{Q} the projection map π_n is a splitting on HH (cf. 1.3.16). Hence by Proposition 2.3.3 it induces a splitting on HC . The rest of the proposition follows by inspection of the diagram

$$\begin{array}{ccccccc} \Omega^{n-1} & \longrightarrow & \Omega^n & \longrightarrow & \Omega^n / d\Omega^{n-1} & & \\ \downarrow & & \downarrow & & \downarrow & & \\ HH_{n-1} & \rightarrow & HC_{n-1} & \rightarrow & HH_n & \rightarrow & HC_n . \quad \square \end{array}$$

2.3.6 The Characteristic Zero Case. Under the hypothesis k contains \mathbb{Q} , the analysis of the situation is far easier. Indeed $(1/n!)\pi_n$ induces a map of bicomplexes from $\mathcal{B}(A)$ (cf. 2.1.7) to the *bicomplex of truncated de Rham complexes*

$$\mathcal{D}(A) : \begin{array}{ccccc} & & 0\downarrow & & 0\downarrow & & 0\downarrow & & \\ & & \Omega_{A|k}^2 & \xleftarrow{d} & \Omega_{A|k}^1 & \xleftarrow{d} & \Omega_{A|k}^0 & & \\ & & 0\downarrow & & 0\downarrow & & & & \\ & & \Omega_{A|k}^1 & \xleftarrow{d} & \Omega_{A|k}^0 & & & & \\ & & 0\downarrow & & & & & & \\ & & \Omega_{A|k}^0 & & & & & & \end{array}$$

[this follows from 1.3.14 and (2.3.4.1)]. The complex $\text{Tot}\mathcal{D}(A)$ is sometimes called the *reduced Deligne complex*. In other words $(1/n!)\pi_n$ induces a map of mixed complexes (c.f. 2.5.13):

$$(C(A), b, B) \rightarrow (\Omega_{A|k}^*, 0, d) .$$

Since in $\mathcal{D}(A)$ the vertical differential is zero, the homology groups of the total complex are easy to compute. This gives the following

2.3.7 Proposition. *When k contains \mathbb{Q} and A is unital and commutative the projection map π induces a canonical map*

$$HC_n(A) \rightarrow \Omega_{A|k}^n / d\Omega_{A|k}^{n-1} \oplus H_{DR}^{n-2}(A) \oplus H_{DR}^{n-4}(A) \oplus \dots$$

The last summand is H^0 or H^1 depending on n being even or odd.

Proof. The spectral sequence associated to the bicomplex $\mathcal{D}(A)$ degenerates at the E^1 -level since the vertical differential is trivial. Hence $E_{pq}^1 = H_{DR}^{q-p}(A)$ for $p \neq 0$ and $E_{0n}^1 = \Omega^n / d\Omega^{n-1}$, whence the result. \square

Remark. We will show in 4.6.10 that this map is in fact a direct sum of maps, one for each component of the right-hand side.

2.4 Cyclic Cohomology

This section is mainly a translation of the preceding sections into the cohomological framework. We only give the definitions, the notation and the statements. Proofs are omitted when they are immediate translation of their homological analogues.

The reasons for adding such a section are the following: firstly, several papers are written in this framework, including the seminal paper by A. Connes; secondly, there is an interesting pairing between cyclic homology and cyclic cohomology (2.4.8); finally topological algebras are easier to handle in the cohomological framework, but this will be dealt with in Sect. 5.6.

Hochschild cohomology was treated in Sect. 1.5, from which we adopt the notation.

2.4.1 Definition. Let A be an associative and unital k -algebra. The dual $A^* = \text{Hom}(A, k)$ of A is also denoted $C^0(A)$. More generally we put $C^n(A) = \text{Hom}(A^{\otimes n+1}, k)$.

Dualizing the bicomplex $CC_{**}(A)$ gives a bicomplex of cochains $CC^{**}(A)$ such that $CC^{pq}(A) = C^q(A)$. It has vertical differential maps b^* or b'^* : $CC^{pq} \rightarrow CC^{p+1q}$ and horizontal differential maps $(1-t)^*$ or N^* : $CC^{pq} \rightarrow CC^{p+1q}$.

By definition *cyclic cohomology* of A is the homology of the cochain complex $\text{Tot } CC^{**}(A)$:

$$HC^n(A) := H^n(\text{Tot } CC^{**}(A)).$$

2.4.2 Connes' Definition. A cochain f in $C^n(A)$ is said to be *cyclic* if it satisfies the relation

$$(2.4.2.1) \quad f(a_0, \dots, a_n) = (-1)^n f(a_n, a_0, \dots, a_{n-1}), \quad a_i \in A.$$

These *cyclic cochains* form a sub- k -module of $C^n(A)$ denoted $C_\lambda^n(A)$. The important discovery of A. Connes is that the image under b^* (also denoted

β in Sect.1.5) of cyclic cochains is still a cyclic cochain. This is the cohomological analogue of statement 2.1.1. Hence $(C_\lambda^*(A), b^*)$ is a well-defined sub-complex of $(C^*(A), b^*)$ whose homology is denoted $H_\lambda^*(A)$.

If k contains \mathbb{Q} , then the inclusion map $C_\lambda^*(A) \hookrightarrow C^*(A)$ induces an isomorphism

$$H_\lambda^n(A) \rightarrow HC^n(A), \quad n \geq 0.$$

2.4.3 The $\mathcal{B}^*(A)$ -Complex. In the bicomplex of cochains $CC^{**}(A)$ one can get rid of the acyclic b^* -columns. As a result it becomes quasi-isomorphic to the following bicomplex of cochains

$$\begin{array}{ccccc} \mathcal{B}^*(A) : & & \uparrow & & \uparrow & & \uparrow \\ & & C^2(A) & \xrightarrow{B^*} & C^1(A) & \xrightarrow{B^*} & C^0(A) \\ & & b^* \uparrow & & b^* \uparrow & & \\ & & C^1(A) & \xrightarrow{B^*} & C^0(A) & & \\ & & b^* \uparrow & & & & \\ & & C^0(A) & & & & \end{array}$$

The normalized version of $\mathcal{B}^*(A)$ is a subcomplex $\overline{\mathcal{B}}^*(A)$ made of $\overline{C}^n(A)$. This latter group consists of cochains $f : A^{\otimes n+1} \rightarrow k$ which vanish on elements (a_0, \dots, a_n) for which at least one entry $a_i, i \geq 1$, is equal to 1.

In conclusion, there are quasi-isomorphisms of complexes of cochains

$$\text{Tot } \overline{\mathcal{B}}^*(A) \hookrightarrow \text{Tot } \mathcal{B}^{**}(A) \leftarrow \text{Tot } CC^{**}(A),$$

and therefore canonical isomorphisms of k -modules

$$H_n(\text{Tot } \overline{\mathcal{B}}^*(A)) \cong H_n(\text{Tot } \mathcal{B}^{**}(A)) \cong HC_n(A).$$

We leave to the reader the task of defining cyclic cohomology of non-unital algebras.

2.4.4 Connes Periodicity Exact Sequence (Cohomological Form).

Any associative k -algebra A gives rise to a long exact sequence

$$\dots \rightarrow HH^n(A) \xrightarrow{B} HC^{n-1}(A) \xrightarrow{S} HC^{n+1}(A) \xrightarrow{I} HH^{n+1}(A) \xrightarrow{B} \dots$$

As a corollary, if k contains \mathbb{Q} , then there is a long exact sequence

$$\dots \rightarrow HH^n(A) \xrightarrow{B} H_\lambda^{n-1}(A) \xrightarrow{S} H_\lambda^{n+1}(A) \xrightarrow{I} HH^{n+1}(A) \xrightarrow{B} \dots,$$

which is the original exact sequence discovered by A. Connes.

2.4.5 Elementary Computations. For any unital k -algebra A , one has $HC^0(A) = HH^0(A) = H^0(A, A^*) = (A^*)^A = \{f : A \rightarrow k \mid f(aa') = f(a'a)\}$ for any $a, a' \in A$. Such an element is called a *trace* on A .

For $A = k$, it is immediate from the (B^*, b^*) -complex that

$$HC^{2n}(k) = k \quad \text{and} \quad HC^{2n+1}(k) = 0, \quad n \geq 0.$$

It will be shown later that $HC^*(A)$ can be equipped with a graded commutative algebra structure when A is unital and commutative (cf. Sect. 4.2). In particular for $A = k$, if we denote by u the canonical generator of $HC^2(k)$, then $HC^*(k)$ can be identified with the polynomial algebra $k[u]$ with u in degree 2.

2.4.6 Morita Invariance. Let $\mathcal{M}_r(A)$ be the associative k -algebra of $r \times r$ -matrices with entries in the unital k -algebra A . The cotrace map induces an isomorphism

$$\text{cotr}^* : HC^*(A) \cong HC^*(\mathcal{M}_r(A)).$$

This is an immediate translation of the homological statement.

2.4.7 Cycles Over an Algebra. By definition an *abstract cycle* of degree n is a DG-algebra $\Omega = \Omega^0 \oplus \Omega^1 \oplus \dots \oplus \Omega^n$ with a differential d of degree $+1$ and a closed graded trace $\int : \Omega^n \rightarrow k$. In other words the data (Ω, d, \int) is supposed to verify

- (a) $d(\omega\omega') = (d\omega)\omega' + (-1)^{|\omega|} \omega d\omega'$,
- (b) $d^2 = 0$,
- (c) $\int \omega_2\omega_1 = (-1)^{|\omega_1||\omega_2|} \int \omega_1\omega_2$,
- (d) $\int d\omega = 0$ for $\omega \in \Omega^{n-1}$.

Let A be a k -algebra. By definition a *cycle over A* is an abstract cycle (Ω, d, \int) and a morphism $\varrho : A \rightarrow \Omega^0$. This cycle is said to be *reduced* if

- (1) Ω is generated by $\varrho(A)$ as a DG-algebra,
- (2) if $\omega \in \Omega$ and $\int \omega\omega' = 0$ for any $\omega' \in \Omega$, then $\omega = 0$.

From any reduced cycle over A one can construct its *character*, which is the multilinear functional $\tau : A^{\otimes n+1} \rightarrow k$ given by

$$\tau(a_0, \dots, a_n) = \int \varrho(a_0) d\varrho(a_1) \dots d\varrho(a_n).$$

One can show that τ is a cyclic cocycle and that any cyclic cocycle is the character of some reduced cycle. This gives rise to numerous examples of non-trivial cyclic cohomology classes (cf. Connes [C, p. 114] and [1990, p.88]).

2.4.8 Pairing, Duality. In 1.5.9 we defined a Kronecker product pairing Hochschild homology with Hochschild cohomology. In the particular case

$M = A^*$ and $M' = A$ one can compose the Kronecker product with the evaluation map to get

$$(2.4.8.1) \quad \langle \cdot, \cdot \rangle : HH^n(A) \times HH_n(A) \rightarrow A^* \otimes_{A^e} A \xrightarrow{ev} k ,$$

where $ev(f, a) = f(a)$. This product is obviously extendable to the cyclic theory (and still called the Kronecker product)

$$(2.4.8.2) \quad \langle \cdot, \cdot \rangle_{HC} = \langle \cdot, \cdot \rangle : HC^n(A) \times HC_n(A) \rightarrow k ,$$

since at the chain level one can verify that $\langle B^*(f), x \rangle = \langle f, B(x) \rangle$ for any $f \in C^n(A)$ and $x \in C_{n-1}(A)$.

The resulting map $HC^n(A) \rightarrow \text{Hom}(HC_n(A), k)$ is sometimes an isomorphism, for instance if $A = k$ or, if k is a field.

It is clear that the Kronecker product also exists for the H^λ - H_λ -theories:

$$(2.4.8.3) \quad \langle \cdot, \cdot \rangle : H^\lambda_n(A) \times H_\lambda_n(A) \rightarrow k .$$

The comparison of the trace and the cotrace morphisms with the Kronecker product gives rise to an *adjunction formula*

$$(2.4.8.4) \quad \langle \text{cotr}(f), x' \rangle = \langle f, \text{tr}(x') \rangle \text{ for } f \in HC^n(A) \text{ and } x' \in HC_n(\mathcal{M}_r(A)).$$

Exercises

E.2.4.1. Extend cyclic cohomology to the non-unital case.

E.2.4.2. Let k be a field. Assume that the k -algebra A is finite-dimensional as a k -vector space. Show that the map $HC^*(A) \rightarrow \text{Hom}(HC_*(A), k)$ is an isomorphism.

E.2.4.3. Let $k = \mathbb{Z}$ and $A = \mathbb{Q}$. Show that $HC_{2n}(\mathbb{Q}|\mathbb{Z}) = \mathbb{Q}$, $HC_{2n+1}(\mathbb{Q}|\mathbb{Z}) = 0$, but that $HC^n(\mathbb{Q}|\mathbb{Z}) = 0$ for all $n \geq 0$.

2.5 Cyclic Modules

In this section we axiomatize the properties of the simplicial module $C(A)$ (defined by $[n] \longmapsto A^{\otimes n+1}$) with respect to the action of the cyclic group $\mathbb{Z}/(n+1)\mathbb{Z}$ on $A^{\otimes n+1}$. It gives rise to the notion of *cyclic module*, first described by A. Connes in [1983]. Almost all the constructions and theorems of the previous sections can be carried over to this context. In fact most of them do not even require to start with a cyclic module, but only with an intermediate structure called a *mixed complex* that we introduce in (2.5.13). Several useful mixed complexes do not come from cyclic modules.

More generally there is defined a notion of cyclic object in a category. This aspect will be treated in full generality in Sect. 6.1. When the category is abelian all the constructions done in the k -module case can be carried over.

Notation. The standard generator of $\mathbb{Z}/(n+1)\mathbb{Z}$ is denoted by t_n or simply t (image of $1 \in \mathbb{Z}$).

2.5.1 Definition. A *cyclic module* C is a simplicial k -module endowed for all $n \geq 0$ with an action of the cyclic group $\mathbb{Z}/(n+1)\mathbb{Z}$ on C_n subject to the following relations

$$(2.5.1.1) \quad \begin{cases} t_n^{n+1} = id, \\ d_i t_n = -t_{n-1} d_{i-1} & \text{and } s_i t_n = -t_{n+1} s_{i-1} \text{ for } 1 \leq i \leq n, \\ d_0 t_n = (-1)^n d_n & \text{and } s_0 t_n = (-1)^n t_{n+1}^2 s_n \end{cases}$$

for $d_i : C_n \rightarrow C_{n-1}$ and $s_i : C_n \rightarrow C_{n+1}$.

A *morphism of cyclic modules* $f : C \rightarrow C'$ is a morphism of simplicial modules which commutes with the cyclic structure, i.e. $f_n t_n = t_n f_n$ for all n .

The *product of two cyclic modules* C and C' is the cyclic module $C \times C'$ such that

$$(2.5.1.2) \quad \begin{aligned} (C \times C')_n &= C_n \otimes C'_n, \\ d_i &= d_i \otimes d_i, \quad s_j = s_j \otimes s_j, \quad t_n = (-1)^n t_n \otimes t_n. \end{aligned}$$

2.5.2 Notation. Since there will be several types of homology associated with a cyclic module C we will often write $HH_*(C)$ for the homology $H_*(C, b)$ of the underlying simplicial module. This is consistent with our convention of replacing C by A when $C = C(A)$.

2.5.3 Cyclic Objects in Abelian Categories. In this section we concentrate on the category of k -modules, but it is clear how to define a cyclic object in any abelian category \mathcal{E} : it is a simplicial object $(E_n)_{n \geq 0}$ in \mathcal{E} (cf. Appendix B) together with a morphism $t_n : E_n \rightarrow E_n$ for all $n \geq 0$ satisfying formulas (2.5.1.1) (see Sect. 6.1 for a definition in terms of functors). In particular one can work out cyclic homology of cyclic chain complexes as follows. Any simplicial chain complex (C, d) determines a bicomplex (C_{**}, d, b) , with homology $HH_*(C, d) := H_*(\text{Tot } C_{**})$ (sometimes called *hyperhomology*). If this is a cyclic chain complex, then the cyclic operators permit us to construct a B -map, whence a tri-complex (C_{***}, d, b, B) , whose homology $HC_*(C, d) := H_*(\text{Tot } C_{***})$ is, by definition, *cyclic homology of the cyclic chain complex*.

We put signs depending on n in formulas (2.5.1.1) only because then they disappear in the computations (cf. 2.1.1). It is also possible to give definitions of abelian cyclic objects without signs so that then we can define cyclic sets, cyclic spaces, etc. This will be done in Chap. 6.

2.5.4 Proposition. *Let A be an associative and unital k -algebra. The simplicial module $[n] \mapsto A^{\otimes n+1}$ equipped with the action of the cyclic group $\mathbb{Z}/(n+1)\mathbb{Z}$ given by*

$$t_n(a_0, \dots, a_n) = (-1)^n(a_n, a_0, \dots, a_{n-1})$$

is a cyclic module that we denoted by $C(A)$.

Proof. The formulas were checked in 2.1.1. □

Most of the results concerning the cyclic module $C(A)$ and proved in the previous sections are valid for any cyclic module. The proofs are all strictly the same because we only used the simplicial structure and formulas (2.5.1.1).

2.5.5 The Cyclic Bicomplex. To any cyclic module C there is associated the cyclic bicomplex CC :

$$\begin{array}{cccc}
 \downarrow & & \downarrow & & \downarrow & & \downarrow \\
 C_2 & \xleftarrow{1-t} & C_2 & \xleftarrow{N} & C_2 & \xleftarrow{1-t} & C_2 & \xleftarrow{N} \\
 b \downarrow & & -b' \downarrow & & b \downarrow & & -b' \downarrow \\
 C_1 & \xleftarrow{1-t} & C_1 & \xleftarrow{N} & C_1 & \xleftarrow{1-t} & C_1 & \xleftarrow{N} \\
 b \downarrow & & -b' \downarrow & & b \downarrow & & -b' \downarrow \\
 C_0 & \xleftarrow{1-t} & C_0 & \xleftarrow{N} & C_0 & \xleftarrow{1-t} & C_0 & \xleftarrow{N}
 \end{array}$$

where $b = \sum_{i=0}^n (-1)^i d_i$, $b' = \sum_{i=0}^{n-1} (-1)^i d_i$, and $N = \sum_{i=0}^n t^i$.

The commutation relations $b(1-t) = (1-t)b'$, $b'N = Nb$ follow from (2.5.1.1) as in the proof of Lemma 2.1.1.

2.5.6 Definition. *Cyclic homology* of the cyclic module C is the homology of the total complex $\text{Tot } CC$:

$$HC_n(C) := H_n(\text{Tot } CC).$$

It is immediate to check that HC_n (resp. HC_*) is a functor from the category of cyclic modules to the category of k -modules (resp. graded k -modules).

Remark that the definition of CC , and so the definition of cyclic homology, does not require the existence of the degeneracy operators. Therefore we call *precyclic module* a presimplicial module with cyclic operators satisfying the relations involving only t_n and d_i in (2.5.1.1). Then HC_n is well-defined on the category of precyclic modules. The main example of such a precyclic module is $C_n(A) = A^{\otimes n+1}$ where A is a (non-unital) k -algebra.

A morphism of (pre)cyclic modules $f : C \rightarrow C'$ induces a morphism of graded modules $f_* : HC_*(C) \rightarrow HC_*(C')$.

2.5.7 The Extra Degeneracy. The operator $s = s_{n+1} = (-1)^{n+1}t_{n+1}s_n : C_n \rightarrow C_{n+1}$ satisfies all the relations of the degeneracy operators except that d_0s_{n+1} is in general different from s_nd_0 . It is a good reason to call it the *extra degeneracy*. Its properties make it into a homotopy in the b' -complex: $sb' + b's = id$. In the particular case of $C = C(A)$ it takes the form $s(a_0, \dots, a_n) = (1, a_0, \dots, a_n)$ (cf. 1.1.12).

2.5.8 Theorem (Connes' Periodicity Exact Sequence). *For any cyclic module C there is a long exact sequence*

$$\dots \rightarrow HH_n(C) \xrightarrow{I} HC_n(C) \xrightarrow{S} HC_{n-2}(C) \xrightarrow{B} HH_{n-1}(C) \xrightarrow{I} \dots$$

Proof. Cf. 2.2.1. □

2.5.9 Connes' Complex. The formula $b(1 - t_n) = (1 - t_{n-1})b'$ proves that b is still well-defined on $C_n^\lambda(C) = C_n/(1 - t_n)$ and we denote by $H_n^\lambda(C)$ the homology of Connes' complex

$$(C_*^\lambda) \quad \dots \rightarrow C_n^\lambda \xrightarrow{b} C_{n+1}^\lambda \rightarrow \dots \rightarrow C_0^\lambda .$$

If k contains \mathbb{Q} , then the natural map $p : HC_n(C) \rightarrow H_n^\lambda(C)$ is an isomorphism (same proof as in 2.1.5). More generally there is a first-quadrant spectral sequence $E_{pq}^1 = H_p(\mathbb{Z}/(q + 1)\mathbb{Z}, C_q) \Rightarrow HC_{p+q}(C)$. Remark that formulas of 2.2.6 and 2.2.7 are still valid in this general framework.

2.5.10 The Bicomplexes \mathcal{BC} and $\overline{\mathcal{BC}}$. From the acyclicity of the b' -complex, Lemma 2.1.6 permits us to get rid of the b' -columns in CC . What is left is the bicomplex

$$\begin{array}{ccccc} & & \downarrow & & \downarrow & & \downarrow & & \\ & & C_2 & \xleftarrow{B} & C_1 & \xleftarrow{B} & C_0 & & \\ & & b \downarrow & & b \downarrow & & & & \\ & & C_1 & \xleftarrow{B} & C_0 & & & & \\ & & b \downarrow & & & & & & \\ & & C_0 & & & & & & \end{array}$$

where $B = (-1)^{n+1}(1 - t_{n+1})sN : C_n \rightarrow C_{n+1}$ is called *Connes' boundary map*. The relations

$$b^2 = B^2 = bB + Bb = 0$$

are proved as in Sect. 2.1. Each column can be replaced by its normalized version (cf. 2.1.9) and we get a new bicomplex $\overline{\mathcal{BC}}$ with \overline{C}_n in place of C_n . The horizontal differential has the form $\overline{B} = sN$. The bicomplex \mathcal{BC} (and similarly $\overline{\mathcal{BC}}$) gives rise to an exact sequence of complexes

$$0 \rightarrow C \rightarrow \text{Tot } \mathcal{BC} \xrightarrow{S} \text{Tot } \mathcal{BC}[2] \rightarrow 0$$

from which one can also deduce Connes' exact sequence.

2.5.11 Theorem. *For any cyclic complex C the maps of complexes*

$$\text{Tot } CC \leftarrow \text{Tot } \mathcal{BC} \rightarrow \text{Tot } \overline{\mathcal{BC}}$$

are quasi-isomorphisms and therefore

$$HC_*(C) = H_*(\text{Tot } CC) \cong H_*(\text{Tot } \mathcal{BC}) \cong H_*(\text{Tot } \overline{\mathcal{BC}}) . \quad \square$$

2.5.12 Definition-proposition. An *equivalence of cyclic modules* is a morphism of cyclic modules $f : C \rightarrow C'$ which induces an isomorphism on the homology of the underlying simplicial modules $HH_*(C) \cong HH_*(C')$. An equivalence of cyclic modules induces an isomorphism in cyclic homology $f_* : HC_*(C) \cong HC_*(C')$ and conversely.

Proof. Cf. 2.2.3. □

2.5.13 Mixed Complexes. These latter results show that some basic properties of cyclic homology can be derived from the bicomplex \mathcal{BC} alone. Hence it is helpful to introduce the following notion. By definition a *mixed complex* (C, b, B) is a family of modules $C_n, n \geq 0$, equipped with a chain map of degree $-1, b : C_n \rightarrow C_{n-1}$, and a chain map of degree $+1, B : C_n \rightarrow C_{n+1}$, satisfying

$$(2.5.13.1) \quad b^2 = B^2 = bB + Bb = 0 .$$

Of course any cyclic module gives rise to a mixed complex, but there are other examples.

Any mixed complex determines a first-quadrant bicomplex \mathcal{BC} (cf. 2.5.10). The *ordinary homology of the mixed complex* (C, b, B) is the homology of the first column of \mathcal{BC} , that is the homology of the complex $(C, b) : HH_*(C) = H_*(C, b)$. By definition *cyclic homology of the mixed complex* (C, b, B) is the homology of the bicomplex \mathcal{BC} , that is $HC_*(C) := H_*(\text{Tot } \mathcal{BC})$. As already seen in 2.5.10, there is an exact sequence of complexes

$$0 \rightarrow (C, b) \rightarrow \text{Tot } \mathcal{BC} \xrightarrow{S} \text{Tot } \mathcal{BC}[2] \rightarrow 0$$

where S is factoring out by the first column. This short exact sequence gives rise to a long (periodicity) exact sequence

$$\begin{aligned} \dots \rightarrow HC_{n-1}(C) \xrightarrow{B} HH_n(C) \xrightarrow{I} HC_n(C) \xrightarrow{S} HC_{n-2}(C) \\ \rightarrow HH_{n-1}(C) \rightarrow \dots \end{aligned}$$

Of course there is an immediate notion of *morphism of mixed complexes*: it is a sequence of maps $f_n : C_n \rightarrow C'_n$, $n \geq 0$, such that f_n commutes with b and B . However there is a larger class of morphisms defined as follows.

2.5.14 Definition. An *S-morphism* of mixed complexes $f : (C, b, B) \rightarrow (C', b, B)$ is a morphism of complexes $f : \text{Tot } \mathcal{B}C \rightarrow \text{Tot } \mathcal{B}C'$ which commutes with S .

Explicitly, $(\text{Tot } \mathcal{B}C)_n = C_n \oplus C_{n-2} \oplus C_{n-4} \oplus \dots$ and therefore a morphism from $\text{Tot } \mathcal{B}C$ to $\text{Tot } \mathcal{B}C'$ can be represented as a matrix of morphisms (from C_{n-2i} to C'_{n-2j}). The condition of commutation with S implies that this matrix is of the form

$$f^{(-)} = \begin{bmatrix} f^{(0)} & f^{(1)} & \dots & & \\ f^{(-1)} & f^{(0)} & f^{(1)} & \dots & \\ \dots & f^{(-1)} & f^{(0)} & f^{(1)} & \dots \\ & & & \dots & \dots \end{bmatrix}$$

with $f^{(i)} : C_{*-2i} \rightarrow C'_*$. The condition “ f is a morphism of complexes” is equivalent to

$$(2.5.14.1) \quad [B, f^{(i)}] + [b, f^{(i+1)}] = 0.$$

Conversely a sequence of complex maps $f^{(i)}$ (of degree $2i$), $i \in \mathbb{Z}$, satisfying (2.5.14.1) determines an *S-morphism* (a morphism of mixed complexes is a particular case with $f^{(i)} = 0$ for $i \neq 0$).

An *S-morphism* induces a map $f_* : HC_*(C) \rightarrow HC_*(C')$. The commutation condition with S implies the commutativity of the diagram

$$\begin{array}{ccccccc} 0 & \rightarrow & C & \rightarrow & \text{Tot } \mathcal{B}C & \xrightarrow{S} & \text{Tot } \mathcal{B}C[2] \rightarrow 0 \\ & & \downarrow f^{(0)} & & \downarrow f & & \downarrow f[2] \\ 0 & \rightarrow & C' & \rightarrow & \text{Tot } \mathcal{B}C' & \xrightarrow{S} & \text{Tot } \mathcal{B}C'[2] \rightarrow 0. \end{array}$$

Taking the homology and applying the five lemma inductively proves the following generalization of proposition 2.5.12:

2.5.15 Proposition. Let $f : (C, b, B) \rightarrow (C', b, B)$ be an *S-morphism* of mixed complexes. Then $f_*^{(0)} : HH_*(C) \rightarrow HH_*(C')$ is an isomorphism if and only if $f_* : HC_*(C) \rightarrow HC_*(C')$ is an isomorphism. \square

2.5.16 Remark. In most cases the *S-morphisms* that we will have to deal with are such that $f^{(i)} = 0$ if $i \neq 0$ and 1. Hence conditions (2.5.14.1) reduce to

$$(2.5.16.1) \quad [b, f^{(0)}] = 0.$$

$$(2.5.16.2) \quad [B, f^{(0)}] + [b, f^{(1)}] = 0 .$$

$$(2.5.16.3) \quad [B, f^{(1)}] = 0 .$$

2.5.17 Extreme Cases of Comodule Structure. For any cyclic module C the graded group $HC_*(C)$ is a $k[u]$ -comodule:

$$HC_*(C) \rightarrow k[u] \otimes HC_*(C) , x \mapsto \sum_{i \geq 0} u^i \otimes S^i(x) .$$

There are two extreme cases: the free case and the trivial case.

a) *Free Comodule Case.* When $HC_*(C)$ is free as a $k[u]$ -comodule, there are isomorphisms of graded modules

$$HC_*(C) \cong HC_*(k) \otimes HH_*(C) \cong k[u] \otimes HH_*(C) ,$$

where $|u| = 2$. Under this hypothesis the map B is 0 and Connes exact sequence splits into short exact sequences

$$0 \rightarrow HH_n(C) \rightarrow HC_n(C) \rightarrow HC_{n-2}(C) \rightarrow 0 .$$

This happens when the mixed complex (C, b, B) is quasi-isomorphic to some mixed complex $(C', \partial, 0)$ for instance. An example is given by the cyclic module associated to the nerve of a discrete group (cf. 7.3.9).

b) *Trivial Comodule Case.* The forgetful functor from cyclic modules to simplicial modules admits a left adjoint F (see 7.1.5 for more details). Suppose that $C \cong F(D)$ for some simplicial module D . Then one can show that the S -map is trivial and so the $k[u]$ -comodule structure is trivial. Then Connes exact sequence splits into short exact sequences:

$$0 \rightarrow HC_{n-1}(C) \rightarrow HH_n(C) \rightarrow HC_n(C) \rightarrow 0 .$$

In fact there are isomorphisms $HC_n(C) \cong HH_n(D)$ and $HH_n(C) \cong HH_n(D) \oplus HH_{n-1}(D)$.

Topologically these two cases correspond to trivial S^1 -spaces and S^1 -spaces of the form $S^1 \times Y$ with S^1 -action only on the S^1 component, respectively (cf. also 4.4.7).

Exercises

E.2.5.1. Show that an exact sequence of cyclic modules

$$0 \rightarrow C' \rightarrow C \rightarrow C'' \rightarrow 0$$

induces a long exact sequence in homology

$$\dots \rightarrow HC_n(C') \rightarrow HC_n(C) \rightarrow HC_n(C'') \rightarrow HC_{n-1}(C') \rightarrow \dots$$

E.2.5.2. Cyclic Homology of Small Categories. Let \mathcal{A} be a small category such that for any objects A and A' the set $\text{Hom}(A, A')$ is endowed with a k -module structure and composition of morphisms is a k -bilinear map. Let $C_n(\mathcal{A}) = \oplus [\text{Hom}(A_n, A_0) \otimes \text{Hom}(A_0, A_1) \otimes \dots \otimes \text{Hom}(A_{n-1}, A_n)]$ where the direct sum is over all sequences (A_0, \dots, A_n) of objects of \mathcal{A} . Show that there is defined a cyclic k -module structure on the simplicial module $[n] \mapsto C_n(\mathcal{A})$. Denote its cyclic homology by $HC_*(\mathcal{A})$. Check that the particular case where \mathcal{A} has only one object $*$, with morphisms $\text{Hom}(*, *) = A$ (composition being multiplication in A) is our classical example. Let $\mathcal{P}(A)$ be the category of finitely generated projective modules over A (made small). Show that there is a canonical isomorphism $HC_*(A) \cong HC_*(\mathcal{P}(A))$. Deduce a new proof of Morita invariance (cf. McCarthy [1992a]).

E.2.5.3. Let (C, b, B) and (C', b, B) be two mixed complexes and let $f : (C, b) \rightarrow (C', b)$ be a map of complexes. Show that for any map $h : C \rightarrow C'$ of degree one (i.e. $h : C_n \rightarrow C'_{n+1}$) the following are equivalent:

- (a) $f + [h, b]$ is a map of mixed complexes,
- (b) $f = f^{(0)}$ and $f^{(1)} = [h, B]$ form an S -morphism (in the sense of 2.5.16, i.e. $f^{(i)} = 0$ otherwise).

E.2.5.4. Poisson Algebras. By definition a *Poisson algebra* is a commutative k -algebra S equipped with a bilinear map $\{-, -\} : S \otimes S \rightarrow S$ (Poisson bracket) satisfying:

- (i) $\{-, -\}$ is a Lie bracket,
- (ii) $\{-, -\}$ is a derivation in each variable.
- (a) Let \mathfrak{g} be a Lie algebra (cf. Sect. 10.1). Show that the symmetric algebra $S(\mathfrak{g})$ is a Poisson algebra with Poisson bracket $\{g, h\} = [g, h]$ for $g, h \in S^1(\mathfrak{g})$.
- (b) Let $S = S(\mathfrak{g})$ and let $\Omega_{S|k}^n$ be the module of n -forms on the Poisson algebra S and let d denote, as usual, the exterior differentiation operator. Define $\delta : \Omega_{S|k}^n \rightarrow \Omega_{S|k}^{n-1}$ by the formula

$$\begin{aligned} \delta(s_0 ds_1 \dots ds_n) &:= \sum_{1 \leq i \leq n} (-1)^i \{s_0, s_i\} ds_1 \dots \widehat{ds}_i \dots ds_n \\ &+ \sum_{1 \leq i < j \leq n} (-1)^{i+j-1} s_0 d\{s_i, s_j\} ds_1 \dots \widehat{ds}_i \dots \widehat{ds}_j \dots ds_n. \end{aligned}$$

Show that $(\Omega_{S|k}^*, \delta, d)$ is a mixed complex (cf. Koszul [1985], Brylinski [1988], Kassel [1988]).

2.6 Non-commutative Differential Forms

For a commutative algebra A the module of n -differential forms is defined as the n th exterior power of the module of 1-forms. This construction gives a symmetric A -bimodule and works only when A is commutative. For a non-commutative algebra A , A. Connes [C] and M. Karoubi [1987] define the module of n -forms by taking the iterated tensor product of the (non-symmetric) bimodule of 1-forms. This, together with b , gives a differential graded algebra whose abelianization yields a complex. Non-commutative de Rham homology is defined as the homology of this complex.

It turns out that this new module of n -forms is nothing but the module $\overline{C}_n(A)$ of the normalized Hochschild complex. This permits them to relate non-commutative de Rham homology to cyclic homology (Theorem 2.6.7).

This point of view has the advantage of yielding almost the same formalism as for ordinary forms, and so it permits them to extend the classical differential calculus (connections, curvature, characteristic classes, etc.) to non-commutative algebras.

Our exposition follows essentially Karoubi [1987].

2.6.1 Non-commutative 1-Forms. Let $\mu : A \otimes A \rightarrow A$ be the product map of the k -algebra A . In the commutative case it was shown (cf. 1.3.9) that the derivation functor is representable by I/I^2 where $I = \text{Ker } \mu$. In the non-commutative case the derivation functor $\text{Der}_k(A, M)$ where M is an A -bimodule is also representable: $\text{Der}_k(A, M) \cong \text{Hom}_{A^e}(I, M)$, $D \mapsto (1 \otimes x - x \otimes 1 \mapsto Dx)$ since $1 \otimes ab - ab \otimes 1 = (1 \otimes a - a \otimes 1)b + a(1 \otimes b - b \otimes 1)$. So it is natural to take I as the bimodule of 1-forms.

In fact we have already met this bimodule under a different guise in 1.1.14.

2.6.2 Lemma. *The map $(x, y) \mapsto x \otimes y - xy \otimes 1$ is an isomorphism of A -bimodules*

$$\overline{C}_1(A) = A \otimes \overline{A} \cong I .$$

Proof. One first remarks that $x \otimes y - xy \otimes 1$ depends only on the class of y in \overline{A} , so the map is well-defined and obviously its image is in I . The quotient of $A \otimes A$ by the relations $x \otimes y - xy \otimes 1 = 0$ for $x, y \in A$ maps isomorphically to A (with inverse map given by $x \mapsto \text{class of } x \otimes 1$). Therefore the kernel of this factor map is isomorphic to the kernel of μ . \square

2.6.3 Bimodule Structure of $\overline{C}_1(A)$ and Notation. The kernel I is a sub- A -bimodule of $A \otimes A$. So, by the isomorphism of Lemma 2.6.2, $\overline{C}_1(A)$ becomes an A -bimodule. In order to write down this structure in a more familiar way, let us introduce the following notation: an element $(x, y) \in \overline{C}_1(A)$ (or equivalently $x \otimes y - xy \otimes 1$ in I) is written xdy . The left module

structure is simply $a(xdy) = (ax)dy$. However the right module structure is more subtle. The equalities

$$\begin{aligned} (x \otimes y - xy \otimes 1)a &= x \otimes ya - xy \otimes a \\ &= x \otimes ya - xya \otimes 1 - (xy \otimes a - xya \otimes 1) \end{aligned}$$

in $A \otimes A$, written with the new notation, give $(xdy)a = xd(ya) - xyda$. So we have the classical formula

$$d(uv) = udv + (du)v, \quad \text{for any } u, v \in A,$$

which describes the right A -module structure of I .

2.6.4 Differential Algebra of Non-commutative Forms $(\overline{C}(A), d)$. In the commutative case the space of n -forms was defined by taking the exterior power on 1-forms. In the non-commutative case we simply take the tensor power of non-commutative 1-forms, that is $\overline{C}_1(A) \otimes_A \dots \otimes_A \overline{C}_1(A)$. It turns out that this module is simply $\overline{C}_n(A)$ with the identification $a_0 da_1 \dots da_n = (a_0, \dots, a_n)$. So, from now on, $\overline{C}(A) = \bigoplus_{n \geq 0} \overline{C}_n(A)$ (with $\overline{C}_0(A) = A$) is considered as a graded algebra and the element (a_0, \dots, a_n) of $\overline{C}_n(A)$ will be written $a_0 da_1 \dots da_n$. The product in this algebra is performed by using the rules of d , for instance $(dx)(ydz) = (d(xy) - xdy)dz = d(xy)dz - xdydz$. There is obviously defined a differential map

$$d : \overline{C}_n(A) \rightarrow \overline{C}_{n+1}(A), a_0 da_1 \dots da_n \mapsto da_0 da_1 \dots da_n$$

which makes $(\overline{C}(A), d)$ into a differentiable graded algebra (DG-algebra for short). Commutators in this DG-algebra and the map b are related by the following formula.

2.6.5 Lemma. *For any $\omega \in \overline{C}_n(A)$ and any $a \in \overline{C}_0(A) = A$ one has*

$$b(\omega da) = (-1)^{|\omega|} [\omega, a] = (-1)^{|\omega|} (\omega a - a \omega),$$

where b is the Hochschild boundary.

Proof. Let $\omega = a_0 da_1 \dots da_{n-1}$ and $a = a_n$. One first checks that

$$d_n(a_0 da_1 \dots da_n) = a_n a_0 da_1 \dots da_{n-1} = a \omega.$$

So it suffices to check that $b'(\omega da) = (-1)^{|\omega|} \omega a$. This is a consequence of the rule $(dx)y = d(xy) - xdy$ applied several times. \square

2.6.6 Non-commutative de Rham Homology. Recall that in a graded algebra the (graded) commutator is given by $[\omega, \omega'] = \omega \omega' - (-1)^{|\omega||\omega'|} \omega' \omega$. The abelianization of $\overline{C}(A)$ is $\overline{C}(A)_{\text{ab}} = \overline{C}(A) / [\overline{C}(A), \overline{C}(A)]$. The differential d is well-defined on the abelianization and so $(\overline{C}(A)_{\text{ab}}, d)$ is a complex.

By definition the *non-commutative de Rham homology* of A is $HDR_*(A) := H_*(\overline{C}(A)_{\text{ab}}, d)$. This theory is closely related to cyclic homology as will be seen below.

Suppose that (Ω, ∂) is a DG-algebra over k and let $\varrho : A \rightarrow \Omega^0$ be a k -algebra map. As $(\overline{C}(A), d)$ is universal among DG-algebras whose 0th term is A , there is a unique extension of ϱ to a DG-map: $a_0 da_1 \dots da_n \mapsto \varrho(a_0) \partial \varrho(a_1) \dots \partial \varrho(a_n)$. So for any such data there is defined a map

$$H_*(\overline{C}(A)_{\text{ab}}, d) \rightarrow H_*(\Omega_{\text{ab}}, d).$$

An interesting example is, when A is commutative, $\Omega = \Omega_{A|k}^*$ with $\varrho = id_A$. It gives a map from non-commutative de Rham homology to ordinary de Rham homology (compare with 2.3.7).

It will be shown later that for smooth algebras there is an isomorphism $HDR_n(A) \cong \bigoplus_{0 \leq i < n/2} H_{DR}^{n-2i}(A)$ for $n > 0$.

There is defined a reduced *non-commutative de Rham homology* by

$$\overline{HDR}_n(A) := H_n(\overline{C}(A)/(k + [\overline{C}(A), \overline{C}(A)]), d).$$

As usual this reduced theory fits into an exact sequence

(2.6.6.1)

$$\dots \rightarrow HDR_n(k) \rightarrow HDR_n(A) \rightarrow \overline{HDR}_n(A) \rightarrow HDR_{n-1}(k) \rightarrow \dots$$

Since $HDR_n(k) = 0$ for $n > 0$, there is an isomorphism $HDR_n(A) \cong \overline{HDR}_n(A)$ for $n \geq 1$.

2.6.7 Theorem. *Assume that k contains \mathbb{Q} and let A be a unital k -algebra. Then non-commutative de Rham homology and cyclic homology are related by the exact sequence*

$$0 \rightarrow \overline{HDR}_n(A) \rightarrow \overline{HC}_n(A) \xrightarrow{B} \overline{HH}_{n+1}(A), \quad n \geq 0.$$

In other words, non-commutative de Rham homology is the kernel of Connes map B or equivalently the image of the periodicity map S . Note that this can be taken as a definition of \overline{HDR} if one does not want to introduce non-commutative differential forms but wishes to work with cyclic homology instead.

We begin the proof of the theorem with two lemmas explaining the behavior of b and B under abelianization. Recall that the component of degree n in $\overline{C}(A)_{\text{ab}}$ is the quotient of $\overline{C}(A)$ by the submodule generated by the commutators $[\omega, \omega']$ with $\omega \in \overline{C}_i(A)$, $\omega' \in \overline{C}_j(A)$, $i + j = n$. We denote this quotient by $\overline{C}_n(A)_{\text{ab}}$ for $n > 0$. For $n = 0$ we define $\overline{C}_0(A)_{\text{ab}} := A/(k + [A, A])$ in order to work with \overline{HDR} .

2.6.8 Lemma. *For any unital k -algebra A there is a commutative diagram*

$$\begin{array}{ccc} \overline{C}_n(A) & \xrightarrow{b} & \overline{C}_{n-1}(A) \\ \downarrow & & \downarrow \\ \overline{C}_n(A)_{ab} & \xrightarrow{0} & \overline{C}_{n-1}(A)_{ab} \end{array}$$

and the induced map $\overline{HH}_n(A) \rightarrow \overline{C}_n(A)_{ab}$ is injective when k contains \mathbb{Q} .

Proof. The first assertion is a direct consequence of Lemma 2.6.5.

In order to prove the second assertion, we introduce the endomorphism σ of $\overline{C}_n(A)$ given by $\sigma(\omega da) := (-1)^{|\omega|} da \omega$ for $n \geq 1$ and by $\sigma(a_0) = a_0$ for $n = 0$. From the definition of b and d it comes immediately

$$(2.6.8.1) \quad 1 - \sigma = bd + db .$$

Though σ is not of finite order, it is of order n modulo $b \overline{C}_{n+1}(A)$. Indeed the following formula holds on $\overline{C}_n(A)$:

$$(2.6.8.2) \quad \sigma^n = 1 + b\sigma^n d .$$

The proof of this formula is as follows:

$$\begin{aligned} \sigma^n(a_0 da_1 \dots da_n) &= da_1 \dots da_n a_0 \\ &= a_0 da_1 \dots da_n + [da_1 \dots da_n, a_0] \\ &= a_0 da_1 \dots da_n + (-1)^n b(da_1 \dots da_n da_0) \\ &= a_0 da_1 \dots da_n + b\sigma^n d(a_0 da_1 \dots da_n) . \end{aligned}$$

By (2.6.8.1) σ commutes with b and therefore $\overline{HH}_n(A)$ is a submodule of the module of invariants $(\overline{C}_n(A)/\text{Im } b)^\sigma$. By (2.6.8.2) σ is of order n on $\overline{C}_n(A)/\text{Im } b$, so, since k contains \mathbb{Q} , the module of invariants coincides with the module of coinvariants $\overline{C}_n(A)/\text{Im } b + \text{Im } (1 - \sigma)$. Let us show that this is in fact $\overline{C}_n(A)_{ab}$ for $n \geq 1$. The submodule of commutators in $\overline{C}_n(A)$ is linearly generated by the commutators $[\omega, a]$ and $[\omega', dx]$, $\omega \in \overline{C}_n(A)$, $\omega' \in \overline{C}_{n-1}(A)$, a and $x \in A$. By Lemma 2.6.5 the first type corresponds to $\text{Im } b$. The second type corresponds to factoring out by the action of σ .

Summarizing: $\overline{HH}_n(A)$ is a submodule of $(\overline{C}_n(A)/\text{Im } b)^\sigma = \overline{C}_n(A)/\text{Im } b + \text{Im } (1 - \sigma) = \overline{C}_n(A)_{ab}$. For $n = 0$ $\overline{HH}_0(A)$ is precisely equal to $A/(k + [A, A]) = \overline{C}_0(A)_{ab}$. \square

2.6.9 Lemma. For any unital k -algebra A there is a commutative diagram

$$\begin{array}{ccc} \overline{C}_n(A) & \xrightarrow{B} & \overline{C}_{n+1}(A) \\ \downarrow & & \downarrow \\ \overline{C}_n(A)_{ab} & \xrightarrow{(n+1)d} & \overline{C}_{n+1}(A)_{ab} . \end{array}$$

Proof. It suffices to check that in $\overline{C}_{n+1}(A)_{ab}$ the equality $da_n da_0 \dots da_{n-1} - da_0 \dots da_n = 0$ holds. This is immediate since the right-hand part of this equality is the commutator $[da_n, da_0 \dots da_{n-1}]$. □

2.6.10 End of the Proof of Theorem 2.6.7. Let $\overline{C}_n^\lambda(A)$ be the module $C_n^\lambda(A)$ (cf. 2.1.4) quotiented by the submodule generated by the elements (a_0, \dots, a_n) such that at least one of the entries a_i is 1. Then $\overline{C}_n(A)_{ab}/\text{Im } d$ is isomorphic to $\overline{C}_n^\lambda(A)/\text{Im } b$ as they are equal to $C_n(A)$ quotiented by the same set of relations (cf. 2.6.5 and the last sentence in the proof of 2.6.8).

Consider now the following diagram

$$\begin{array}{ccc} \overline{C}_n(A)_{ab}/\text{Im } d \cong \overline{C}_n^\lambda(A)/\text{Im } b & \longrightarrow & \overline{C}_{n+1}(A)/\text{Im } b \\ & & \downarrow b \\ & & \overline{C}_n(A) \\ \overline{C}_{n-1}^\lambda(A) & \xrightarrow{B} & \overline{C}_n(A) \end{array}$$

By Lemma 2.6.8 $\overline{HH}_{n+1}(A)$ can be considered as a submodule of

$$\overline{C}_{n+1}(A)_{ab}.$$

Then, for $\omega \in \overline{C}_n(A)_{ab}/\text{Im } d$, one has

$$\begin{aligned} (n+1)d(\omega) \in \overline{HH}_{n+1}(A) &\Leftrightarrow B(\omega) \in \overline{HH}_{n+1}(A) \\ &\Leftrightarrow bB(\omega) = 0 \Leftrightarrow Bb(\omega) = 0 \Leftrightarrow db(\omega) = 0. \end{aligned}$$

Consequently the n th homology group of the complex

$$\overline{C}_0(A)_{ab} \rightarrow \dots \rightarrow \overline{C}_n(A)_{ab} \rightarrow \overline{C}_{n+1}(A)/\overline{HH}_{n+1}(A)$$

is $H_n(\overline{C}_*^\lambda(A), b)$. The equality $H_n(\overline{C}_*^\lambda(A), b) = \overline{HC}_n(A)$ (cf. 2.2.15) permits us to finish the proof. □

Finally the comparison with de Rham homology in the commutative case is given by the following

2.6.11 Proposition. *Let A be a unital commutative k -algebra (and $k \supset \mathbb{Q}$). Then the following diagram is commutative for $n \geq 1$,*

$$\begin{array}{ccc} \overline{HDR}_n(A) & \hookrightarrow & \overline{HC}_n(A) \\ e_* \downarrow & & \downarrow \\ H_{DR}^n(A) & \hookrightarrow & \Omega_{A|k}^n/d\Omega_{A|k}^{n-1}. \end{array} \quad \square$$

Exercises

E.2.6.1. Show that HDR is a homotopy invariant functor: $HDR_*(A[t]) \cong HDR_*(A)$ [cf. Sect. 4.1].

E.2.6.2. Let $A * A$ be the coproduct of two copies of A in the category of unital associative k -algebras. Show that there is an algebra isomorphism $A * A \cong \overline{C}(A)$ provided that $\overline{C}(A)$ is equipped with the Fedosov product \circ given by

$$\omega \circ \omega' = \omega\omega' + (-1)^{|\omega|} d\omega d\omega'.$$

[For x in the first copy of A (resp. y in the second), send x to $x + dx$ (resp. y to $y - dy$) cf. Cuntz-Quillen [1992].]

Bibliographical Comments on Chapter 2

Historically, the lifting of the differential operator d on forms as the operator B on Hochschild chains was first discovered by G. Rinehart (a student of G. Hochschild) and published in the second part of his paper [1963, §9 and 10]. His notation for B is simply d (see loc.cit. p. 221). Moreover he discovered most of the properties of this operator: relationship with b , with the derivation operators, with the product structure. There is no mention of the (b, B) -bicomplex, nor cyclic homology though everything is at hand. It seems that this part of the paper was not very well understood and forgotten. C. Kassel drew it to my attention. The cyclic complex C_*^λ for a tensor algebra is hinted in a paper by Hsiang and Staffeldt [1982], see Chap. 10.BC for more.

The cyclic complex C_*^λ was invented (in the cohomological framework) by A. Connes [C] and appeared independently in B. Tsygan's work on homology of Lie algebras [1983]. A. Connes rediscovered the operator B . The relationship between the (b, B) -bicomplex and the C_*^λ -complex was made clear in Loday-Quillen [LQ] through the construction of the cyclic bicomplex (inspired by Tsygan's work). In Kassel [1989a] it is proved that the complexes $\mathcal{B}(A)$ and $C^\lambda(A)$ are retract by deformation of $CC(A)$.

Connes periodicity exact sequence was first proved by him in characteristic zero (cf. Connes [C]), but also appeared in Tsygan's announcement [1983]. The characteristic free proof appeared in Loday-Quillen [LQ] and independently in Connes [1983]. The Morita invariance can be found in several places: Connes [C, Cor. 24], Loday-Quillen [LQ, Cor. 1.7], of the general case the proof is in McCarthy [1988] and in Kassel [1989a]. The explicit formula for S (Theorem 2.2.7) can be found in Connes [C, p. 323] and Karoubi [1987, p. 27].

The abstract notion of cyclic modules and cyclic objects appeared first in Connes [1983]. The notion of a mixed complex is probably present in many places in the literature before cyclic homology was discovered (see for instance André [1974]). It was introduced by D. Burghelea [1986, p. 93] under the name algebraic S^1 -chain complex and studied systematically by Kassel [1987]. The present terminology was coined by C. Kassel [1987] who introduced also the notion of S -morphism.

The framework of non-commutative differential forms is present in A. Connes [C], and also in early work of M. Karoubi [1983, 1987] on the subject. The idea of taking the kernel of μ as a substitute for the module of 1-forms is already in Quillen [1970, p. 70]. For a recent development see Cuntz-Quillen [1992].

Most of the results of this chapter are also dealt with in Feigin-Tsygan [FT]. This (sort of) monograph contains a definition of cyclic homology (called additive K -theory) by means of derived functors on a non-abelian category (see also Feigin-Tsygan [1985]). This tool gives different proofs of many results in the cyclic theory. In Quillen [1988] a different approach to the cyclic bicomplex is treated by means of the DG-coalgebra structure of the bar construction.

Chapter 3. Smooth Algebras and Other Examples

This chapter is devoted to the computation of Hochschild and cyclic homologies of some particular types of algebras: tensor algebras, symmetric algebras, universal enveloping algebras of Lie algebras and, finally, smooth algebras, on which we put some emphasis. One more important example, the case of group algebras, will be treated later, in Sect. 7.4. It is also shown in this chapter that Hochschild and cyclic homology are related to many other theories such as the homology of Lie algebras, André-Quillen homology of commutative algebras, and Deligne cohomology.

Most of the time the computation of the Hochschild homology of a specific algebra consists in constructing an ad hoc resolution. In order to compute the cyclic homology the game consists in figuring out what plays the role of Connes boundary map B . This gives rise to a smaller complex from which it is easier to compute the cyclic homology (for a systematic treatment, see Exercise E.3.1.3).

In Sect. 3.1 we consider tensor algebras. The result for Hochschild is well-known, but the proof given here, which is slightly different from the classical one, works without the hypothesis of a projective property.

In Sect. 3.2 we deal with polynomial algebras. This is the first step of many computations. It will be generalized (with a slightly different proof) to smooth algebras in Sect. 3.4. We show that the case of polynomial (versus smooth) algebras has some particular features (see Remark 3.2.3).

Section 3.3 contains an application of the preceding section to the computation of HH and HC of filtered algebras whose associated graded algebra is polynomial. The main example is the universal enveloping algebra of a Lie algebra. In this case Hochschild homology is precisely the homology of the Lie algebra. The computation of cyclic homology gives rise to a simple mixed complex.

In Sect. 3.4 the important case of smooth algebras is dealt with. The main point is the Hochschild-Kostant-Rosenberg (HKR) theorem which asserts that for smooth algebras, Hochschild homology coincides with differential forms:

$$HH_n(A) = \Omega_{A|k}^n .$$

In fact this result was (and is) used quite often the other way round: in order to generalize some results on forms to non-smooth algebras, or even to non-commutative algebras, one can substitute Hochschild homology groups for the

module of forms. The next important point is that, in Hochschild homology, Connes boundary map B plays the role of the exterior differential operator d (cf. 2.3). Then cyclic homology can be compared with de Rham homology. For a smooth algebra A , in characteristic zero, one has an isomorphism

$$HC_n(A) \cong \Omega_{A|k}^n / d\Omega_{A|k}^{n-1} \oplus H_{DR}^{n-2}(A) \oplus H_{DR}^{n-4}(A) \oplus \dots$$

There are several ways of defining a smooth algebra. Our choice is based on the notion of regular sequence so that the proof given here is close to the original proof of HKR. In the next section another proof is sketched starting with a different definition of smoothness (equivalent with the first one in the noetherian case). Appendix E is devoted to a comprehensive comparison of the different definitions of smoothness.

Section 3.5 is devoted to André-Quillen homology theory of commutative algebras. We introduce the important notion of a cotangent complex, which gives rise to this homology theory. This is the right framework in which to deal with smooth algebras.

In Sect. 3.6 we give a short account of Deligne cohomology theory in the affine case. This theory is important because of its modified version called Deligne-Beilinson cohomology theory. It is closely related to cyclic homology in the smooth case and this comparison is interesting because of the product structures (see 3.6.6).

The case of a group algebra $k[G]$ of a group G is very similar to the universal enveloping algebra case and would perfectly fit in this chapter. However, because of its importance in the relationship of cyclic homology with S^1 -spaces and with algebraic K -theory (Chern character), its treatment is postponed to Sect. 7.4.

For the notation and terminology of tensor, symmetric and exterior algebras, see Appendix A.

3.1 Tensor Algebra

In this section we compute the Hochschild homology and cyclic homology of a tensor algebra. For the former, one can introduce a particular resolution to get a small complex. In fact one can show that this complex is quasi-isomorphic to the Hochschild complex by providing explicit homotopies. This permits us to get rid of the flatness hypothesis used in Loday-Quillen [LQ, p. 582].

3.1.1 The Small Complex of a Tensor Algebra. Let V be any k -module and let $A = T(V) = k \oplus V \oplus V^{\otimes 2} \oplus \dots$ be its tensor algebra. The element $(v_1, \dots, v_n) \in V^{\otimes n}$ is denoted by $v_1 \dots v_n$ and is said to be of length n . The product in $T(V)$ is concatenation: $(v_1 \dots v_n)(v'_1 \dots v'_n) = v_1 \dots v_n v'_1 \dots v'_n$. We denote by $\tau : V^{\otimes n} \rightarrow V^{\otimes n}$ the cyclic permutation, $\tau(v_1 \dots v_n) = (v_n v_1 \dots v_{n-1})$.

Let $C^{\text{small}}(T(V))$ be the complex

$$\dots \longrightarrow 0 \longrightarrow A \otimes V \longrightarrow A$$

where the module A is in degree 0 and where the non-trivial map is given by $(a, v) \mapsto av - va$.

3.1.2 Proposition. *Let $\phi : A \otimes A \rightarrow A \otimes V$ be defined by*

$$\phi(a, v_1 \dots v_n) = \sum_{i=1}^n v_{i+1} \dots v_n a v_1 \dots v_{i-1} \otimes v_i \text{ for } n \geq 1, \text{ and } \phi(a, 1) = 0.$$

The map $\Phi : \overline{C}(A) \rightarrow C^{\text{small}}(A)$, which is the identity in degree 0 and ϕ in degree 1, is a quasi-isomorphism of complexes.

Proof. There is an obvious inclusion of complexes $\iota : C^{\text{small}}(A) \rightarrow \overline{C}(A)$ such that $\Phi \circ \iota = id$. Let us prove that $\iota \circ \Phi$ is homotopic to $id_{C(A)}$.

Let $h_n : \overline{C}_n(A) \rightarrow \overline{C}_{n+1}(A)$ be defined inductively (according to the length of the last entry) by

$$\begin{aligned} h_0 &= 0, \\ h_n(a_0, \dots, a_{n-1}, v) &= 0 \quad \text{and} \\ h_n(a_0, \dots, a_{n-1}, a_n v) &= h_n(v a_0, \dots, a_n) + (-1)^n (a_0, \dots, a_n, v) \text{ for } n \geq 1. \end{aligned}$$

A straightforward computation shows that

$$\begin{aligned} b h_n + h_{n-1} b &= id_{C_n(A)} \quad \text{when } n \geq 2, \\ b h_1 + h_0 b &= id_{C_1(A)} - \iota \circ \phi \quad \text{for } n = 1. \end{aligned}$$

Hence h is a homotopy from $id_{C(A)}$ to $\iota \circ \Phi$ and the complexes $\overline{C}(T(V))$ and $C^{\text{small}}(T(V))$ are quasi-isomorphic. \square

3.1.3 Remarks. Suppose that V is free of rank 1 over k with generator x . Then $T(V)$ is the polynomial algebra $k[x]$. The composite $A \otimes A \xrightarrow{\phi} A \otimes V \cong A$ is given by $p(x) \otimes q(x) \mapsto p(x)q'(x)$ where $q'(x)$ denotes the derivative of the polynomial $q(x)$. Note that $C^{\text{small}}(T(V))$ can be thought of as $T(V) \otimes_{T(V) \otimes T(V)^{\text{op}}} C^{\text{sm}}(T(V))$ where $C^{\text{sm}}(T(V))$ is the resolution

$$\dots \rightarrow 0 \rightarrow 0 \rightarrow T(V) \otimes V \otimes T(V) \rightarrow T(V) \otimes T(V) \xrightarrow{\mu} T(V) \rightarrow 0.$$

3.1.4 Theorem. *For any k -module V Hochschild homology of $A = T(V)$ is*

$$\begin{aligned} HH_0(A) &= \bigoplus_{m \geq 0} V^{\otimes m} / (1 - \tau) = \bigoplus_{m \geq 0} (V^{\otimes m})_{\tau} \quad (\text{coinvariants}), \\ HH_1(A) &= \bigoplus_{m \geq 1} (V^{\otimes m})^{\tau} \quad (\text{invariants}), \\ HH_n(A) &= 0 \quad \text{for } n \geq 2. \end{aligned}$$

Proof. One checks that b restricted to $V^{\otimes m-1} \otimes V$ is precisely $(1-\tau) : V^{\otimes m} \rightarrow V^{\otimes m}$ for $m \geq 1$:

$$b(v_1 \dots v_{m-1} \otimes v_m) = v_1 \dots v_m - v_m v_1 \dots v_{m-1} = (1-\tau)(v_1 \dots v_m). \quad \square$$

Note that $\text{sgn}(\tau)$ is not involved here.

In order to compute cyclic homology of $A = T(V)$, we replace, in the bicomplex $\overline{B}(A)$, every vertical Hochschild complex by a copy of the length-one complex $C^{\text{small}}(A)$. We need to know what plays the role of Connes' map B . The answer is given by the following

3.1.5 Proposition. *Let $\gamma : A \rightarrow A \otimes V$ be defined by*

$$\gamma(v_1 \dots v_n) = \sum_{i=1}^n v_{i+1} \dots v_n v_1 \dots v_{i-1} \otimes v_i.$$

The cyclic homology of the tensor algebra $A = T(V)$ is the homology of the (periodic) complex

$$\dots \xrightarrow{\gamma} A \otimes V \xrightarrow{b} A \xrightarrow{\gamma} A \otimes V \xrightarrow{b} \dots \xrightarrow{b} A.$$

Proof. Remark that $\gamma(a) = \phi(1, a)$. The following diagram

$$\begin{array}{ccc} & & \downarrow \\ & & A \otimes V \xleftarrow{\gamma} A \\ & & \downarrow b \\ A \otimes V & \xleftarrow{\gamma} & A \\ \downarrow b & & \\ A & & \end{array}$$

can be considered as a bicomplex since $b\gamma = \gamma b = 0$ by the following argument: $b\gamma(a) = b\phi(1, a) = b(1, a) = 0$ and $\gamma b(a, v) = \gamma(av - va) = \phi(1, av) - \phi(1, va) = \phi(a, v) + \phi(v, a) - \phi(a, v) - \phi(v, a) = 0$.

Its total complex is the complex described in the statement. The morphism of complexes Φ extends to a morphism from $\overline{B}(A)$ to this new complex since $\gamma \circ id = \phi \circ \overline{B}$. By 3.1.2 this is a quasi-isomorphism of bicomplexes, whence the assertion. \square

3.1.6 Theorem. *Cyclic homology of a tensor algebra is given by*

$$HC_n(T(V)) = HC_n(k) \oplus \bigoplus_{m>0} H_n(\mathbb{Z}/m\mathbb{Z}, V^{\otimes m}),$$

where the generator of $\mathbb{Z}/m\mathbb{Z}$ acts by τ on $V^{\otimes m}$ (so for $n \geq 1$ it is periodic of period 2). In particular, if k contains \mathbb{Q} , then $HC_n(T(V)) = HC_n(k)$ for $n > 0$ and $HC_0(T(V)) = S(V)$ (symmetric algebra).

Proof. Since $T(V) = \bigoplus_{m \geq 0} V^{\otimes m}$ the complex of Proposition 3.1.5 can be identified with the direct sum of $C(k)$ with the complexes which compute the homology of $\mathbb{Z}/m\mathbb{Z}$ with coefficients in $V^{\otimes m}$ (cf. Appendix C.4). Since $\mathbb{Z}/m\mathbb{Z}$ is a finite group, these homology groups are trivial in positive degree when k contains \mathbb{Q} . \square

3.1.7 Example $A = k[x]$. If V is of dimension 1 and $k = \mathbb{Z}$, then $T(V) = \mathbb{Z}[x]$. So $HC_0(\mathbb{Z}[x]) = \mathbb{Z}[x]$ and for $n > 0$, $HC_{2n}(\mathbb{Z}[x]) = \mathbb{Z}$, $HC_{2n+1}(\mathbb{Z}[x]) = \bigoplus_{m > 0} \mathbb{Z}/m\mathbb{Z}$ (the torsion group $\mathbb{Z}/m\mathbb{Z}$ comes from the fact that the derivative of x^m is mx^{m-1}). On the other hand if k contains \mathbb{Q} , then $HC_*(k[x]) = HC_*(k) \oplus xk[x]$, where $xk[x]$ is concentrated in degree 0.

3.1.8 Remark. In the decomposition of $HC_n(T(V))$ given by Theorem 3.1.6 the periodicity map S corresponds to the periodicity isomorphisms for the homology of cyclic groups (cf. Appendix C.4).

Exercises

E.3.1.1. Let $F : (k\text{-Alg}) \rightarrow (k\text{-Mod})$ be the forgetful functor. Show that the tensor algebra functor T is left adjoint to F .

E.3.1.2. Suppose that V is projective over k . Give a non-computational proof of Proposition 3.1.2.

(Show that there is a projective resolution of A of length one which yields $C^{\text{small}}(A)$, cf. Loday-Quillen [LQ, p. 582].)

E.3.1.3. Perturbation Lemma. A *perturbation* of the complex (A, d_A) is a graded homomorphism $\varrho : A \rightarrow A$ of degree -1 such that $(d_A + \varrho)^2 = 0$ (Show that, for a mixed complex (C, b, B) , B can be considered as a perturbation).

Let $(A, d_A) \xrightleftharpoons[f]{g} (B, d_B)$ be complexes and maps of complexes such that $fg = id_B$. In this situation, a *reduction* is a graded homomorphism $h : A \rightarrow A$ of degree $+1$ such that $fh = 0$, $hg = 0$, $hd_A + d_Ah = id_A - gf$ and $hh = 0$.

Suppose that $h\varrho$ is locally nilpotent (i.e. $\forall a \in A, \exists n \geq 0$ such that $(h\varrho)^n(a) = 0$) and define $\Sigma_\infty := \sum_{i=0}^\infty (-1)^i (h\varrho)^i$. Show that $h_\infty := \Sigma_\infty h$ is a reduction for

$$(A, d_A + \varrho) \xrightleftharpoons[f_\infty]{g_\infty} (B, d_\infty), \quad \text{where } d_\infty := d_B + f\varrho\Sigma_\infty g,$$

$$f_\infty := f(1 - \varrho\Sigma_\infty h), \quad g_\infty := \Sigma_\infty g.$$

Apply this result to give (different) proofs of some of the computations of this chapter (cf. Brown [1967], Kassel [1990]).

E.3.1.4. Weyl Algebra. The Weyl algebra A_n is the associative k -algebra generated by $p_1, \dots, p_n, q_1, \dots, q_n$ subject to the relations

$$[p_i, p_j] = [q_i, q_j] = 0 \quad \text{for all } i, j,$$

$$[p_i, q_j] = \delta_{ij} \quad \text{for all } i, j.$$

(Note that the endomorphisms of $k[x_1, \dots, x_n]$ given by $p_i =$ multiplication by x_i and $q_i = \partial/\partial x_i$ satisfy these relations.) Show that if k contains \mathbb{Q} , then

$$HH_i(A_n) = \begin{cases} k & \text{for } i = 2n, \\ 0 & \text{otherwise,} \end{cases}$$

$$HC_i(A_n) = \begin{cases} k & \text{for } i = 2j, \quad j \geq n, \\ 0 & \text{otherwise.} \end{cases}$$

[Do $n = 1$ first.]

3.2 Symmetric Algebras

The example of polynomial algebras is of course fundamental in the computation of HH and HC of commutative algebras. It will be exploited in Sect. 5.4 where we use differential graded models over polynomial algebras to perform computations.

Hochschild homology of a polynomial algebra is simply the module of differential forms of this algebra (Theorem 3.2.2). This result will be generalized in Sect. 3.4 to smooth algebras. However symmetric algebras are peculiar among smooth algebras since the isomorphism $\Omega_{S(V)|k}^* \cong HH_*(S(V))$ is induced by a chain map.

Cyclic homology is then computable in terms of de Rham homology (Theorem 3.2.5).

3.2.1 Symmetric and Polynomial Algebras. Let V be a module over k and let $S(V)$ be the symmetric algebra over V . Explicitly $S^0(V) = k$, $S^1(V) = V$, $S^n(V) = V^{\otimes n}/\approx$, where the equivalence relation \approx is $(v_1, \dots, v_n) \approx (v_{\sigma(1)}, v_{\sigma(2)}, \dots, v_{\sigma(n)})$ for any permutation $\sigma \in S_n$. We will simply write $v_1 v_2 \dots v_n$ in place of (v_1, v_2, \dots, v_n) . The product is given by concatenation. If V is free of dimension one generated by x , then $S(V)$ is the polynomial algebra $k[x]$. More generally if V is free of dimension n generated by x_1, \dots, x_n then $S(V)$ is the polynomial algebra $k[x_1, \dots, x_n]$.

3.2.2 Theorem. *Let V be a flat k -module. Then there are isomorphisms*

$$\varepsilon_n : \Omega_{S(V)|k}^n \cong S(V) \otimes \Lambda^n V \cong HH_n(S(V)).$$

Proof. The first isomorphism was already proved in 1.3.10 for $n = 1$ and 1.3.11 for all n . For the second isomorphism the proof is divided into two parts.

a) Let us prove the second isomorphism in the particular case of a finite-dimensional free k -module V . For this we introduce the following commutative differential graded algebra $C_*^{\text{sm}}(S(V)) = (S(V) \otimes \Lambda^*V \otimes S(V), \delta)$, where

$$\delta(x \otimes v \otimes y) = xv \otimes y - x \otimes vy, \quad x, y \in S(V), \quad v \in V,$$

and where the product is given (for $u, u' \in \Lambda^*V$) by

$$(x \otimes u \otimes y)(x' \otimes u' \otimes y') = (xx' \otimes u \wedge u' \otimes yy').$$

Let W be another k -module. Then there is an obvious isomorphism of CDG-algebras $C_*^{\text{sm}}(S(V)) \otimes C_*^{\text{sm}}(S(W)) \cong C_*^{\text{sm}}(S(V \oplus W))$. Since V is a finite-dimensional free k -module one can write $V = V_1 \oplus \dots \oplus V_r$ where each V_i is free of dimension 1. It is immediately seen that the complex $C_*^{\text{sm}}(S(V_i))$ is a resolution of $S(V_i)$, that is the following sequence is exact:

$$0 \rightarrow S(V_i) \otimes V_i \otimes S(V_i) \xrightarrow{\delta} S(V_i) \otimes S(V_i) \xrightarrow{\mu} S(V_i) \rightarrow 0$$

(Since V_i is 1-dimensional $S(V_i) = T(V_i)$ and this is the resolution described in Remark 3.1.3.) Therefore $C_*^{\text{sm}}(S(V)) = \otimes_i C_*^{\text{sm}}(S(V_i))$ is a resolution of $\otimes_i S(V_i) = S(V)$. As a consequence $HH_*(S(V))$ is the homology of the complex $C_*^{\text{sm}}(S(V)) \otimes_{S(V) \otimes S(V)} S(V)$ which is

$$(3.2.2.1) \quad \dots \xrightarrow{0} S(V) \otimes \Lambda^n V \xrightarrow{0} S(V) \otimes \Lambda^{n-1} V \xrightarrow{0} \dots \rightarrow S(V).$$

This ends the proof of the case V free and finite-dimensional.

b) If V is flat over k , then there exists a filtered ordered set J and an inductive system of free and finite-dimensional k -modules L_j such that

$$V \cong \varinjlim_{j \in J} L_j$$

(cf. Bourbaki [1980]). Since HH_* and S commute with inductive limits over a filtered ordered set, the flat case follows from the finite-dimensional case. \square

3.2.3 Remark. The composite

$$\Omega_{S(V)|k}^n \rightarrow S(V) \otimes \Lambda^n V \rightarrow HH_n(S(V))$$

is easily seen to be the antisymmetrisation map ε_n (cf. 1.3.4). Indeed the composite of complex maps

$$(S(V) \otimes \Lambda^*V, 0) \rightarrow (\Omega_{S(V)|k}^*, 0) \xrightarrow{\varepsilon} (C_*(S(V)), b)$$

induces on homology the isomorphism given by the proof of Theorem 3.2.2. In other words the map ε_* is induced by a chain map. Note that this is not true in general since ε_n is not a well-defined map from $\Omega_{A|k}^n$ to $C_n(A)$.

3.2.4 Remark. No particular assumption has been made on k in Theorem 3.2.2. For instance k may be equal to \mathbb{Z} . For V finite-dimensional of dimension n , Theorem 3.2.2 gives a computation of $HH_*(k[x_1, \dots, x_n])$. A generalization of Theorem 3.2.2 to smooth algebras will be treated in the next section.

The following result computes cyclic homology of a polynomial algebra. It is a consequence of Theorem 3.2.2 and of Sect. 2.3.

3.2.5 Theorem. *For any flat module V over k there is a canonical isomorphism*

$$HC_*(S(V)) \cong \Omega_{S(V)|k}^* / d\Omega_{S(V)|k}^{*-1} \oplus H_{\text{DR}}^{*-2}(S(V)) \oplus H_{\text{DR}}^{*-4}(S(V)) \oplus \dots$$

Consequently if k contains \mathbb{Q} , then $HC_n(S(V)) = HC_n(k) \oplus \Omega_{S(V)|k}^n / d\Omega_{S(V)|k}^{n-1}$ for $n > 0$.

Proof. The commutativity of the square 2.3.3.1 for $A = S(V)$ implies that there is a mixed complex map (cf. 2.5.13) $(\Omega_{S(V)|k}^*, 0, d) \rightarrow (C_*(S(V)), b, B)$ which is an isomorphism on HH . So, by 2.2.3, it is an isomorphism on HC . The bicomplex deduced from the mixed complex $(\Omega_{S(V)|k}^*, 0, d)$ is

$\mathcal{D}(S(V)) :$

$$\begin{array}{ccccc}
 & & \downarrow & & \downarrow & & \downarrow \\
 & & \Omega^2 & \xleftarrow{d} & \Omega^1 & \xleftarrow{d} & \Omega^0 \\
 & & 0 \downarrow & & 0 \downarrow & & \\
 & & \Omega^1 & \xleftarrow{d} & \Omega^0 & & \\
 & & 0 \downarrow & & & & \\
 & & \Omega^0 & & & &
 \end{array}$$

Since the vertical differential is trivial it is immediate that the homology of the total complex is the right-hand term of Theorem 3.2.5.

When k contains \mathbb{Q} and V is finite-dimensional, then $H_{\text{DR}}^n(S(V)) = 0$ for $n > 0$ (homotopy invariance of de Rham homology). \square

Remark. A computation for $k = \mathbb{Z}$ is indicated in Exercise E.3.2.3

Exercises

E.3.2.1. Give an elementary proof of

$$HH_n(\mathbb{Z}[x]) = \begin{cases} \mathbb{Z}[x] & \text{for } n = 0 \text{ and } 1, \\ 0 & \text{for } n > 1, \end{cases}$$

and deduce the computation of $HC_n(\mathbb{Z}[x])$ (cf. 3.1.7) by using Connes' exact sequence.

E.3.2.2. Compute $HC_*(k[x_1, \dots, x_n])$ when k contains \mathbb{Q} . [Use Theorem 3.2.5, see also Sect. 4.4.]

E.3.2.3. Let $P(n) = \mathbb{Z}[x_1, \dots, x_n]$ be the polynomial algebra over \mathbb{Z} in n variables. Let T (for torsion) be the abelian group $T = \bigoplus_{m \geq 2} \mathbb{Z}/m\mathbb{Z}$. Show that

$$H_{\text{DR}}^0(P(n)) = \mathbb{Z} \oplus nT \oplus 2 \binom{n}{2} T^{\otimes 2} \oplus \dots \oplus 2^{k-1} \binom{n}{k} T^{\otimes k} \oplus \dots \oplus 2^{n-1} \binom{n}{n} T^{\otimes n},$$

and that

$$H_{\text{DR}}^k(P(n)) = \bigoplus_{i=k}^n \binom{n}{i} \binom{i-1}{i-k} T^{\otimes i}, \quad \text{for } k \geq 1.$$

Deduce from this a computation of $HC_*(P(n))$. Compare with the result obtained in Exercise E.3.2.2. (Use Theorem 3.2.5, cf. Lodder [1991].)

E.3.2.4. Give a different proof of $HH_n(S(V)) \cong \Omega_{S(V)|k}^n$ by showing that the cokernel of $S(V) \otimes \Lambda^* V \rightarrow C_*(S(V))$ is acyclic.

[First show that the cokernel splits according to the length. Then filter each piece by the length of the first entry (i.e. a_0 in $a_0 \otimes \dots \otimes a_n$). The associated graded complex is

$$0 \rightarrow \Lambda^n V \xrightarrow{\varepsilon} V^{\otimes n} \rightarrow \dots \rightarrow \bigoplus_{k_1 + \dots + k_i = n} S^{k_1} V \otimes \dots \otimes S^{k_i} V \rightarrow \dots \rightarrow S^n V \rightarrow 0$$

which is acyclic when V is flat over k .]

E.3.2.5. Let L be a flat A -module and $S_A(L)$ the corresponding symmetric algebra (viewed as a k -algebra). Show that there is an isomorphism of graded k -modules,

$$H_*(S_A(L), A) \cong HH_*(A) \otimes_A \Lambda^* L.$$

3.3 Universal Enveloping Algebras of Lie Algebras

Though the universal enveloping algebra $U(\mathfrak{g})$ of a Lie algebra \mathfrak{g} is not commutative in general, it is close to being so since it is endowed with a filtration whose associated graded algebra is commutative. But more than that, this graded algebra is in fact a *symmetric* algebra. This will permit us to relate Hochschild homology of $U(\mathfrak{g})$ to the homology of \mathfrak{g} and then, thanks to the previous section, to derive a “small” complex to compute its cyclic homology. The proof proposed in this section works for any algebra endowed with such a filtration.

3.3.1 Universal Enveloping Algebra of a Lie Algebra. Let \mathfrak{g} be a Lie algebra over k (always assumed to be free as a k -module) and let $U(\mathfrak{g})$ be its universal enveloping algebra (cf. Sect. 10.1). For any $U(\mathfrak{g})$ -bimodule M we denote by M^{ad} the k -module M equipped with the following structure as a right \mathfrak{g} -module:

$$(m \cdot g) = mg - gm, \quad m \in M, \quad g \in \mathfrak{g}.$$

For any \mathfrak{g} -module V the Chevalley-Eilenberg complex is denoted $C_*(\mathfrak{g}, V)$ with boundary map δ (cf. 1.3.4.2). See also Sect. 10.1 in which δ is denoted by d . By definition the homology of \mathfrak{g} with coefficients in V is

$$H_*(\mathfrak{g}, V) := H_*(C_*(\mathfrak{g}, V), \delta).$$

3.3.2 Theorem. *Let \mathfrak{g} be a Lie k -algebra which is free as a k -module and let M be a $U(\mathfrak{g})$ -bimodule. Then there is a canonical isomorphism*

$$H_*(U(\mathfrak{g}), M) \cong H_*(\mathfrak{g}, M^{\text{ad}}).$$

This is a classical result which can be found for instance in Cartan-Eilenberg [CE, Chap. XIII Theorem 7.1]. The proof given here is slightly modified in order to be easily generalizable to certain filtered algebras whose associated graded algebras are symmetric. Moreover this pattern of proof simplifies the computation of cyclic homology. Before starting the proof of the theorem we recall the following result.

3.3.3 Lemma. *The following diagram is commutative*

$$\begin{array}{ccc} U(\mathfrak{g})^{\text{ad}} \otimes \Lambda^n \mathfrak{g} & \xrightarrow{\varepsilon} & \overline{C}_n(U(\mathfrak{g})) \\ \delta \downarrow & & \downarrow b \\ U(\mathfrak{g})^{\text{ad}} \otimes \Lambda^{n-1} \mathfrak{g} & \xrightarrow{\varepsilon} & \overline{C}_{n-1}(U(\mathfrak{g})) \end{array}$$

Proof. The map ε is the composition

$$U(\mathfrak{g})^{\text{ad}} \otimes \Lambda^n \mathfrak{g} \rightarrow U(\mathfrak{g})^{\text{ad}} \otimes \Lambda^n U(\mathfrak{g}) \rightarrow U(\mathfrak{g})^{\otimes n+1},$$

where the first map is induced by the inclusion of \mathfrak{g} in $U(\mathfrak{g})$ and the second one is the antisymmetrization map (cf. 1.3.4). The commutativity of this diagram follows from Proposition 1.3.5 applied to $A = U(\mathfrak{g})$ and $M = U(\mathfrak{g})^{\text{ad}}$. \square

Proof of Theorem 3.3.2. In order to simplify the notation in the proof we treat only the case $M = U(\mathfrak{g})$, denoted U hereafter. The canonical filtration on U (coming from the filtration of the tensor algebra) induces a filtration on $\overline{C}_n(U(\mathfrak{g}))$:

$$F_p \overline{C}_n(U(\mathfrak{g})) = \sum_{k_0 + \dots + k_n = p} F_{k_0} U \otimes \dots \otimes F_{k_n} U .$$

Similarly $F_p(U \otimes \Lambda^n \mathfrak{g}) = F_{p-n} U \otimes \Lambda^n \mathfrak{g}$ is a filtration of $U \otimes \Lambda^n \mathfrak{g}$ and the map of complexes ε respects the filtration.

We are now ready to compare the spectral sequences associated to these two filtered complexes (cf. Appendix D). On the left-hand side the E^1 -term is $S^{p-n}(\mathfrak{g}) \otimes \Lambda^n \mathfrak{g}$ since the differential δ maps $F_{p-n} U \otimes \Lambda^n \mathfrak{g}$ into $F_{p-n} U \otimes \Lambda^{n-1} \mathfrak{g} = F_{p-1}(U \otimes \Lambda^{n-1} \mathfrak{g})$. On the right-hand side the E^1 -term is $HH_*(S(\mathfrak{g}))$ since $\text{gr } F_* C_*(U) = C_*(\text{gr } U) = C_*(S(\mathfrak{g}))$.

By Theorem 3.2.2 the induced map $S(\mathfrak{g}) \otimes \Lambda^n \mathfrak{g} \rightarrow HH_n(S(\mathfrak{g}))$ is an isomorphism. By the comparison theorem of spectral sequences, an isomorphism at the E^1 -level implies an isomorphism on the abutment, that is

$$H_*(\mathfrak{g}, U(\mathfrak{g})^{\text{ad}}) \cong HH_*(U(\mathfrak{g})) . \quad \square$$

3.3.4 The Poincaré-Birkhoff-Witt Theorem and the Poisson Bracket.

From now on, and till the end of the section, we assume that k contains \mathbb{Q} and that the Lie algebra \mathfrak{g} is a free k -module. In order to compute the cyclic homology of $U(\mathfrak{g})$ we need to make explicit the *Poincaré-Birkhoff-Witt (PBW) theorem* as follows. The map

$$\begin{aligned} \eta : S(\mathfrak{g}) &\rightarrow U(\mathfrak{g}) , \\ \eta(x_1 \dots x_n) &= (1/n!) \sum_{\sigma \in S_n} x_{\sigma(1)} \dots x_{\sigma(n)} , \quad x_i \in \mathfrak{g} , \end{aligned}$$

is an isomorphism of k -modules.

The *Poisson bracket* in $S(\mathfrak{g})$ is a bilinear map

$$\{-, -\} : S(\mathfrak{g}) \times S(\mathfrak{g}) \rightarrow S(\mathfrak{g})$$

completely determined by the following two properties:

- a) $\{x, y\} = [x, y]$, for $x, y \in \mathfrak{g}$,
- b) $\{-, -\}$ is a derivation in each variable.

It is easily verified that $\{-, -\}$ is antisymmetric and verifies the Jacobi identity. Hence it is a Lie bracket. One can use this bracket to define a right \mathfrak{g} -module structure on $S(\mathfrak{g})$ as follows:

$$a \cdot g = \{a, g\} , \quad a \in S(\mathfrak{g}) , \quad g \in \mathfrak{g} .$$

This module structure is compatible with the PBW isomorphism, as shown by the following

3.3.5 Lemma. *The PBW isomorphism is \mathfrak{g} -equivariant, that is*

$$\eta(\{a, g\}) = [\eta(a), g] .$$

Proof. It is a purely combinatorial statement. Put $a = x_1 \dots x_n$, $x_i \in \mathfrak{g}$, then the expansion of $n\eta(\{a, g\})$ is a sum of monomials of the form $\pm y_1 \dots y_i g y_{i+1} \dots y_n$ where y_1, \dots, y_n is a permutation of $x_1 \dots x_n$. The signs are such that after simplification, only the monomials with g at the very beginning or at the very end remain alive. And this is precisely $n![\eta(a), g]$. \square

3.3.6 The Mixed Complex $(\Omega_{S(\mathfrak{g})|k}^*, \delta, d)$. As a consequence of the preceding lemma $(U(\mathfrak{g})^{\text{ad}} \otimes \Lambda^* \mathfrak{g}, \delta)$ is canonically isomorphic to $(S(\mathfrak{g}) \otimes \Lambda^* \mathfrak{g}, \delta)$, which is isomorphic to $(\Omega_{S(\mathfrak{g})|k}^*, \delta)$. So Theorem 3.3.2 can be rewritten (when k contains \mathbb{Q}) as:

$$H_*(U(\mathfrak{g}), U(\mathfrak{g})) \cong H_*(\Omega_{S(\mathfrak{g})|k}^*, \delta).$$

One should remark that this new differential map δ on $\Omega_{S(\mathfrak{g})|k}^*$ is of degree -1 and is given by

$$\begin{aligned} \delta(a_0 da_1 \dots da_n) &= \sum_{i=1}^n (-1)^i \{a_0, a_i\} \otimes da_1 \dots \widehat{da}_i \dots da_n \\ &+ \sum_{1 \leq i < j \leq n} (-1)^{i+j} a_0 d\{a_i, a_j\} da_1 \dots \widehat{da}_i \dots \widehat{da}_j \dots da_n. \end{aligned}$$

On the other hand, there is a differential operator of degree $+1$ on $\Omega_{S(\mathfrak{g})|k}^*$, the classical differential operator d . Since $d\delta + \delta d = 0$ (as is easily checked) there is defined a mixed complex $(\Omega_{S(\mathfrak{g})|k}^*, \delta, d)$ whose homology is denoted $HC_*(\Omega_{S(\mathfrak{g})|k}^*, \delta, d)$ (cf. 2.5.13).

3.3.7 Theorem. *Suppose that k contains \mathbb{Q} and let \mathfrak{g} be a Lie k -algebra which is free as a k -module. Then there is a canonical isomorphism*

$$HC_*(U(\mathfrak{g})) \cong HC_*(\Omega_{S(\mathfrak{g})|k}^*, \delta, d).$$

Sketch of the proof. A complete proof of this theorem along the following lines can be found in Kassel [1988b].

The point is to compare the following two mixed complexes :

$$(\Omega_{S(\mathfrak{g})|k}^*, \delta, d) \quad \text{and} \quad (C(U(\mathfrak{g})), b, B).$$

By a method similar to the acyclic model method, one constructs degree 2 maps $\phi^{(i)}$ such that $\phi^{(0)} = \epsilon\eta$ and

$$b\phi^{(i)} - \phi^{(i)}d = \phi^{(i-1)}d - B\phi^{(i-1)}, \quad \text{for } i \geq 1.$$

Then, one can show that this data induces an isomorphism on cyclic homology of the mixed complexes. \square

3.3.8 Almost Symmetric Algebras. Let A be a non-negatively filtered k -algebra. By definition A is *almost symmetric* if its associated graded algebra $\text{gr}(A)$ is isomorphic to the symmetric algebra $S(V)$, where $V = F_1(A)/F_0(A)$. So in particular one asks that $F_0(A) = k$. Then $S(V)$ becomes a Poisson algebra (cf. Exercise E.2.5.4), and there is a well-defined mixed complex $(\Omega_{S(V)|k}^*, \delta, d)$.

3.3.9 Theorem. *If k contains \mathbb{Q} and A is an almost symmetric algebra, then there are isomorphisms*

$$\begin{aligned} HH_*(A) &\cong H_*(\Omega_{S(V)|k}^*, \delta) \quad \text{and} \\ HC_*(A) &\cong HC_*(\Omega_{S(V)|k}^*, \delta, d) . \end{aligned}$$

Proof. A result of Sridharan shows that an almost symmetric algebra is close to a universal enveloping algebra of a Lie algebra. In fact, it is close enough so that the proof for $U(\mathfrak{g})$ extends to almost symmetric algebras (cf. Kassel [1988b]). □

Remark. One could wonder rather Theorem 3.3.9 is extendable to smooth algebras since, as will be shown in the next section, $\Omega_{A|k}^* \cong HH_*(A)$ when A is smooth. The proof given here does not extend as such because we used the fact (not true for smooth algebras in general) that this isomorphism is induced by a chain map (cf. 3.2.3).

Exercise

E.3.3.1. Give a proof of Theorems 3.3.7 and 3.3.9 by using the Perturbation Lemma (Exercise E.3.1.3).

3.4 Smooth Algebras

In this section we introduce the notions of étale algebras and of smooth algebras. Then we prove the Hochschild-Kostant-Rosenberg (HKR) theorem which asserts that in the smooth case Hochschild homology coincides with differential forms:

$$\Omega_{A|k}^n \cong HH_n(A) .$$

In particular Hochschild homology of an étale algebra is trivial.

We apply this result to the computation of cyclic homology to get the isomorphism (at least when k contains \mathbb{Q})

$$HC_n(A) \cong \Omega_{A|k}^n / d\Omega_{A|k}^{n-1} \oplus H_{\text{DR}}^{n-2}(A) \oplus H_{\text{DR}}^{n-4}(A) \oplus \dots .$$

Since $HC_n(A)$ is defined even when A is non-commutative, one may think of cyclic homology as a generalization of de Rham cohomology to the non-commutative setting. In cyclic homology a similar computation for the algebra of C^∞ -functions was first carried out by A. Connes in [C]. This algebraic version is taken out of Loday-Quillen [LQ].

3.4.1 Smooth and Étale Algebras. Let S be a commutative k -algebra with unit element. A sequence (x_1, \dots, x_m) of elements of S is called *regular* if multiplication by x_i in $S/(x_1S + \dots + x_{i-1}S)$ is injective (i.e. x_i is regular in the quotient) for $i = 1, \dots, m$.

The commutative and unital algebra A is *smooth* over k if it is flat over k and if, for any maximal ideal \mathcal{M} of A , the kernel J of the localized map

$$\mu_{\mathcal{M}} : (A \otimes_k A)_{\mu^{-1}(\mathcal{M})} \rightarrow A_{\mathcal{M}}$$

is generated by a regular sequence in $(A \otimes_k A)_{\mu^{-1}(\mathcal{M})}$.

If in the definition of smooth it turns out that the kernel J is 0, then A is said to be *étale* over k .

The following proposition relates these definitions of smooth and étale to other ones used in literature. It will be proved in Appendix E (Proposition 2).

3.4.2 Proposition. *Let k be a Noetherian ring and A a commutative k -algebra which is essentially of finite type. If moreover $\text{Tor}_n^k(A, A) = 0$ for $n > 0$ (e.g. A flat over k), then the following assertions are equivalent and A is said to be ‘smooth’ over k :*

- (a) *The kernel of the map $\mu : A \otimes_k A \rightarrow A$ is a locally complete intersection.*
- (b) *The canonical homomorphism $M \otimes_A \Omega_{A|k}^2 \rightarrow \text{Tor}_2^{A \otimes_k A}(A, M)$ is a surjection for any A -module M and $\Omega_{A|k}^1$ is a projective A -module.*
- (c) *“Jacobian criterion”: let $P = k[X_1, \dots, X_n]_{\mathfrak{m}}$ be a polynomial algebra over k localized at some ideal \mathfrak{m} , and $\phi : P \rightarrow A$ a surjective k -algebra map. Let \mathfrak{p} be a prime ideal in A and \mathfrak{q} its inverse image in P . Then there exist $p_1, \dots, p_r \in P$ which generate $I_{\mathfrak{q}} = \text{Ker}(\phi)$ such that dp_1, \dots, dp_r are linearly independent in $\Omega_{P_{\mathfrak{q}}|k}^1 \otimes_{P_{\mathfrak{q}}} A_{\mathfrak{p}}$ (by linearly independent we understand that the image of this matrix in $A_{\mathfrak{p}}/\mathfrak{p}A_{\mathfrak{p}}$ has rank r).*
- (d) *“Factorization via an étale map”: for any prime ideal \mathfrak{p} of A there is an element $f \notin \mathfrak{p}$ such that there exists a factorization*

$$k \hookrightarrow k[X_1, \dots, X_m] \xrightarrow{\phi} A_f$$

with ϕ étale.

- (e) *For any pair (C, I) , where C is a k -algebra and I an ideal of C such that $I^2 = 0$, the map $\text{Hom}_k(A, C) \rightarrow \text{Hom}_k(A, C/I)$ is surjective (here Hom_k means k -algebra homomorphisms). □*

3.4.3 Examples. If k is a perfect field (e.g. a field of characteristic zero) any finite extension is smooth over k .

The ring of algebraic functions on a non-singular variety over an algebraically closed field k is smooth, e.g. $k[x]$, $k[x_1, \dots, x_n]$, $k[x, x^{-1}]$, $k[x, y, z, t]/(xt - yz = 1)$ are smooth. However $k[x, y]/(x^2 = y^3)$ is not smooth.

3.4.4 Theorem (Hochschild-Kostant-Rosenberg). *For any smooth algebra A over k , the antisymmetrisation map (cf. 1.3.4 and 1.3.12):*

$$\varepsilon_* : \Omega_{A|k}^* \rightarrow HH_*(A)$$

is an isomorphism of graded algebras.

Remark that since A is flat over k , then $HH_n(A) = \text{Tor}_n^{A \otimes A}(A, A)$ (cf. 1.1.13) and this result can be expressed as an isomorphism $\Omega_{A|k}^* \cong \text{Tor}_*^{A \otimes A}(A, A)$.

The pattern of the proof is first to use the local to global principle to reduce the proof to local rings. Then a specific resolution is constructed out of a Koszul complex. The computation using this resolution gives the answer.

Remark that we already proved a particular case of HKR-theorem. Indeed if V is flat over k , then the symmetric algebra $S(V)$ is smooth and the isomorphism $\Omega_{S(V)|k}^n \cong HH_n(S(V))$ was proved in 3.2.2.

3.4.5 Local to Global Principle. In order to check that an A -module homomorphism $\alpha : M \rightarrow N$ is an isomorphism, it suffices to check that, for all maximal ideals \mathcal{M} of A , the localized map $\alpha_{\mathcal{M}} : M_{\mathcal{M}} \rightarrow N_{\mathcal{M}}$ is an isomorphism. In fact, for $x \in \text{Ker } \alpha$ (or $\text{Coker } \alpha$), let $\text{Ann } x$ be the annihilator of x in A and let \mathcal{M} be a maximal ideal containing $\text{Ann } x$. If $x \neq 0$, then its image in $(\text{Ker } \alpha)_{\mathcal{M}}$ is also different from 0, but this is in contradiction with the hypothesis.

3.4.6 Koszul Complex. Let R be a commutative ring, V an R -module and $x : V \rightarrow R$ a linear form on V . Then there is a unique differential map d_x on the exterior algebra $\Lambda_R^* V$ which extends x and which makes $(\Lambda_R^* V, d_x)$ into a DG -algebra. Explicitly $d_x : \Lambda_R^{n+1} V \rightarrow \Lambda_R^n V$ is given by

$$d_x(v_0 \wedge \dots \wedge v_n) = \sum_{i=0}^n (-1)^i x(v_i) v_0 \wedge \dots \wedge \widehat{v}_i \wedge \dots \wedge v_n,$$

so that for $n = 0$, $d_x = x$. The associated complex $\mathcal{K}(x)$ is called a *Koszul complex*.

Koszul complexes will enable us to construct free resolutions in a context slightly more general than needed to prove HKR-theorem.

3.4.7 Proposition. *Let R be a commutative ring and let I be an ideal of R which is generated by a regular sequence in R . Then the morphism $\varepsilon_* :$*

$\Lambda_{R/I}^*(I/I^2) \rightarrow \text{Tor}_*^R(R/I, R/I)$ deduced from $\varepsilon_1 : I/I^2 \cong \text{Tor}_1^R(R/I, R/I)$ is an isomorphism of graded algebras.

Proof. Let $x = (x_1, \dots, x_m)$ be the regular sequence of elements of R which generate I . The linear form $x : R^m \rightarrow R$ given by $x(r_1, \dots, r_m) = \sum x_i r_i$ gives rise to the Koszul complex $\mathcal{K}(x)$, which is a resolution by the following

3.4.8 Lemma. $H_n(\mathcal{K}(x)) = 0$ if $n > 0$ and $H_0(\mathcal{K}(x)) = R/I$.

Proof. By induction on m . For $m = 1$, $\mathcal{K}(x) = \mathcal{K}(x_1)$ is the complex

$$\dots \rightarrow 0 \rightarrow R \xrightarrow{x_1} R.$$

Since by hypothesis the element x_1 generates I , one has $H_0(\mathcal{K}(x_1)) = R/I$. Since (x_1) is assumed to be a regular sequence, it means that multiplication by x_1 is injective and so $H_1(\mathcal{K}(x_1)) = 0$, whence $H_n(\mathcal{K}(x_1)) = 0$ for $n > 0$.

Suppose now that the lemma is true for $m - 1$ and let us prove it for m . The length-one complex $\mathcal{K}(x_m)$ can be considered as an extension of complexes

$$0 \rightarrow \mathcal{K}_0 \rightarrow \mathcal{K}(x_m) \rightarrow \mathcal{K}_1 \rightarrow 0$$

where \mathcal{K}_0 is concentrated in degree 0 (and this module is R) and \mathcal{K}_1 is concentrated in degree 1 (and again is R). The tensor product of this exact sequence of complexes by the Koszul complex $\mathcal{L} = \mathcal{K}(x_1, \dots, x_{m-1})$ is still an exact sequence of complexes. Moreover the middle term is $\mathcal{L} \otimes \mathcal{K}(x_m) = \mathcal{K}(x)$. The associated long exact sequence in homology reads as follows

$$\begin{aligned} K_1 \otimes_R H_n(\mathcal{L}) \xrightarrow{\delta} K_0 \otimes_R H_n(\mathcal{L}) &\rightarrow H_n(\mathcal{K}(x)) \\ &\rightarrow K_1 \otimes_R H_{n-1}(\mathcal{L}) \xrightarrow{\delta} K_0 \otimes_R H_{n-1}(\mathcal{L}). \end{aligned}$$

Since $K_0 = K_1 = R$, it is easy to check that δ is simply multiplication by x_m . In other words the following sequence is exact:

$$\begin{aligned} 0 \rightarrow \text{Coker}(H_n(\mathcal{L}) \xrightarrow{x_m} H_n(\mathcal{L})) &\rightarrow H_n(\mathcal{K}(x)) \\ &\rightarrow \text{Ker}(H_{n-1}(\mathcal{L}) \xrightarrow{x_m} H_{n-1}(\mathcal{L})) \rightarrow 0. \end{aligned}$$

The inductive hypothesis is $H_n(\mathcal{L}) = 0$ for $n > 0$ and $H_0(\mathcal{L}) = R/(x_1 R + \dots + x_{m-1} R)$, therefore we have $H_n(\mathcal{K}(x)) = 0$ for $n > 1$.

For $n = 1$, $H_1(\mathcal{K}(x))$ is the kernel of the multiplication by x_m in $R/(x_1 R + \dots + x_{m-1} R)$. As, by hypothesis, x_m is regular in this ring, we get $H_1(\mathcal{K}(x)) = 0$.

For $n = 0$, $H_0(\mathcal{K}(x))$ is the cokernel of the multiplication by x_m in $R/(x_1 R + \dots + x_{m-1} R)$, that is R/I . \square

End of the Proof of Proposition 3.4.7. Lemma 3.4.8 shows that the Koszul complex $\mathcal{K}(x) = (\Lambda_R^*(R^m), d_x)$ is a free resolution of the R -module R/I .

Upon tensoring by R/I over R , the homology of $(\Lambda_R^*(R^m) \otimes_R R/I, d_x \otimes 1)$ is $\text{Tor}_*^R(R/I, R/I)$. Since the image of x is (by definition) in I , it is immediate that $d_x \otimes 1 = 0$. Therefore these homology groups are $\Lambda_R^*(R^m) \otimes_R R/I = \Lambda_R^*((R/I)^m)$. So we have proved that $\text{Tor}_*^R(R/I, R/I)$ is an exterior R/I -algebra over $\text{Tor}_1^R(R/I, R/I) \cong (R/I)^m = I/I^2$.

It remains to check that the canonical product on the Tor-groups is identical to the exterior algebra product. Indeed this follows from the fact that the exterior algebra product $\mathcal{K}(x) \otimes_R \mathcal{K}(x) \rightarrow \mathcal{K}(x)$ is a homomorphism of complexes lifting $id_{R/I}$. \square

3.4.9 End of the Proof of HKR-Theorem. Since A is flat over k we can work with the Tor-definition of Hochschild homology (cf. 1.1.13): $H_n(A, M) = \text{Tor}_n^{A \otimes A}(A, M)$. By applying the local to global principle to the A -module map ε , HKR-theorem reduces to proving that the map

$$(3.4.9.1) \quad (\Omega_{A|k}^n)_{\mathcal{M}} \rightarrow (\text{Tor}_n^{A \otimes A}(A, M))_{\mathcal{M}}$$

is an isomorphism.

First one notes that $(\Omega_{A|k}^n)_{\mathcal{M}} \cong \Omega_{A_{\mathcal{M}}|k}^n$. Second, the map

$$\theta_n : (\text{Tor}_n^{A \otimes A}(A, M))_{\mathcal{M}} \rightarrow \text{Tor}_n^{(A \otimes A)_{\mu^{-1}(\mathcal{M})}}(A_{\mathcal{M}}, M_{\mathcal{M}})$$

is a natural map relating two homological functors in M . For $n = 0$, θ_0 is an isomorphism (both modules are $M_{\mathcal{M}}$), so by a classical homological argument, θ_n is an isomorphism for all n .

Hence, (3.4.9.1) being an isomorphism is equivalent to

$$(3.4.9.2) \quad (\Omega_{A|k}^n)_{\mathcal{M}} \rightarrow \text{Tor}_n^{(A \otimes A)_{\mu^{-1}(\mathcal{M})}}(A_{\mathcal{M}}, M_{\mathcal{M}})$$

being an isomorphism.

This latter result is Proposition 3.4.7 applied to the case

$$R = (A \otimes A)_{\mu^{-1}(\mathcal{M})} \quad \text{and} \quad R/I = A_{\mathcal{M}}$$

since A is smooth over k . \square

3.4.10 Cyclic Homology of Smooth and Étale Algebras. We are now in position to compute cyclic homology of smooth algebras in terms of differential forms and de Rham homology. Remark that for étale algebras $HH_*(A) = HH_*(k) = 0$ and therefore $HC_*(A) \cong HC_*(k) \otimes_k A$ by Corollary 2.2.3.

3.4.11 Theorem. *If A is smooth over k , then there is a spectral sequence abutting to cyclic homology:*

$$E_{pq}^2 = \left\{ \begin{array}{ll} \Omega_{A|k}^q / d\Omega_{A|k}^{q-1}, & p = 0, \\ H_{\text{DR}}^{q-p}(A), & p > 0. \end{array} \right\} \Rightarrow HC_{p+q}(A).$$

Proof. Consider the spectral sequence associated to the bicomplex $\mathcal{B}(A)$ (cf. 2.1.7). Since A is smooth, by the HKR-theorem $E_{pq}^1 = HH_{q-p}(A) = \Omega_{A|k}^{q-p}$ if $q \geq p \geq 0$ and 0 otherwise. Moreover by Proposition 2.3.3 the d^1 map, which is induced by B , is the exterior differential operator d (or 0), whence the computation of the E^2 -term. \square

3.4.12 Theorem. *If A is smooth over k and if k contains \mathbb{Q} , then there is a canonical isomorphism*

$$HC_n(A) \cong \Omega_{A|k}^n / d\Omega_{A|k}^{n-1} \oplus H_{DR}^{n-2}(A) \oplus H_{DR}^{n-4}(A) \oplus \dots$$

The last summand is H^0 or H^1 depending on n being even or odd.

Proof. The spectral sequence of Theorem 3.4.11 degenerates at E^2 since there is a splitting. In fact, without spectral sequences, one simply compares the bicomplex $\mathcal{B}(A)$ with the bicomplex $\mathcal{D}(A)$ (cf. 2.3.6) of truncated de Rham complexes via the maps π_n . Since rationally π_n induces an inverse of ε_n in homology, this map of bicomplexes is an isomorphism in homology of the columns (thanks to smoothness of A and HKR-theorem). Hence it is an isomorphism for the homology of the total complex (cf. 1.0.12).

The homology of $\text{Tot } \mathcal{B}(A)$ is $HC_*(A)$ (cf. 2.1.8) and the homology of $\text{Tot } \mathcal{D}(A)$ is precisely the right-hand part of the isomorphism in 3.4.12. \square

3.4.13 Remark. It is easy to see how Connes' periodicity exact sequence decomposes in the smooth case:

$$\begin{array}{ccccccc} \dots \rightarrow & HH_n & \xrightarrow{I} & HC_n & \xrightarrow{S} & HC_{n-2} & \xrightarrow{B} & HH_{n-1} & \rightarrow & \dots \\ & \parallel & & \parallel & & \parallel & & \parallel & & \\ \dots \rightarrow & \Omega^n & \rightarrow & \Omega^n / d\Omega^{n-1} & \rightarrow & 0 & & & & \\ & & & \oplus & & & & & & \\ & 0 & \rightarrow & H_{DR}^{n-2} & \rightarrow & \Omega^{n-2} / d\Omega^{n-3} & \rightarrow & \Omega^{n-1} & \rightarrow & \dots \\ & & & \oplus & & \oplus & & & & \\ & & & H_{DR}^{n-4} & = & H_{DR}^{n-4} & & & & \\ & & & \oplus & & \oplus & & & & \\ & & & \dots & = & \dots & & & & \end{array}$$

This decomposition will be generalized later to any commutative algebra (cf. Sect. 4.6).

3.4.14 Remark. Recall that Theorem 3.4.12 is also true for $A = S(V)$, where V is flat over k , without any characteristic hypothesis on k (cf. 3.2.5).

3.4.15 Corollary. *Let HDR_* be the non-commutative de Rham homology as defined in 2.6.6. If A is smooth over k , then*

$$H\mathrm{DR}_n(A) \cong \bigoplus_{0 \leq i \leq n/2} H_{\mathrm{DR}}^{n-2i}(A)$$

(with H_{DR}^0 replaced by H_{DR}^0/k). □

Exercise

E.3.4.1. Let k be a field and let $R = k[X, Y, Z]$ be a polynomial algebra in three variables. Show that the sequence $(a_1, a_2, a_3) = (X(Y-1), Y, Z(Y-1))$ is regular, though (a_1, a_3, a_2) is not (cf. Matsumura [1986]).

3.5 André-Quillen Homology

Still another homology theory for commutative algebras! There are two reasons for giving an account of this theory here. First it is the right tool to analyze the notion of smoothness of an algebra (and more generally of an algebraic variety). Second it is intimately related to Hochschild homology and, in characteristic zero, it permits us to give a splitting of the latter.

We first introduce simplicial resolutions and the cotangent complex which lead to the definition of André-Quillen (AQ-) homology and cohomology theory (together with the higher versions). Then we state their principal properties: Jacobi-Zariski exact sequence, flat base change, localization. The second definition of smooth (and étale) algebras gives rise to an HKR-type theorem. These results are used in appendix E on smooth algebras. Finally the relationship of AQ-theory and HH -theory is exploited to describe a decomposition (in the rational framework) of Hochschild homology of a commutative algebra (Theorem 3.5.9, see Sects. 4.5 and 4.6 for more).

3.5.1 Simplicial Resolutions of Commutative Algebras. By definition a simplicial resolution of the commutative k -algebra A is an A -augmented simplicial commutative k -algebra P_* which is acyclic. It is called a *free resolution* if P_* is a free commutative algebra, i.e. a symmetric algebra over some free k -module. Any commutative k -algebra A possesses a free resolution which can be constructed as follows.

Let $k[i] = k[x_1, \dots, x_i]$ denote the polynomial k -algebra in i variables. Let $\mathcal{P}(A)$ denote the (small) category of polynomial k -algebras over A . An object of $\mathcal{P}(A)$ is an algebra $k[i]$ together with a k -algebra map $\alpha : k[i] \rightarrow A$. A morphism in $\mathcal{P}(A)$ from α to $\alpha' : k[i'] \rightarrow A$ is a k -algebra map $f : k[i] \rightarrow k[i']$ such that $\alpha' = \alpha \circ f$. Consider the forgetful functor $\mathcal{U}(A) : \mathcal{P}(A) \rightarrow (k\text{-Alg})$ which sends α to its source $k[i]$. The idea is to apply the Bousfield-Kan construction (cf. Appendix B.13) to the forgetful functor $\mathcal{U}(A)$ to get a simplicial k -algebra.

So let $\mathcal{C}_{\mathcal{U}(A)}$ be the category associated to $\mathcal{U}(A)$ as follows: an object is a pair (α, x) where $\alpha : k[i] \rightarrow A$ is an object of $\mathcal{P}(A)$ and x is an element of

$\mathcal{U}(A)(\alpha) = k[i]$. A morphism $(\alpha, x) \rightarrow (\alpha', x')$ in $\mathcal{C}_{\mathcal{U}(A)}$ is simply a morphism f in $\mathcal{P}(A)$ such that $f(x) = x'$.

Let P_* be the algebra generated by the nerve of $\mathcal{C}_{\mathcal{U}(A)}$. It is a free resolution of A . Explicitly, its n th term can be described as follows:

$$P_n = \bigotimes_{(f_0, \dots, f_n)} k[i_0]$$

where the tensor product is over all strings of maps

$$k[i_0] \xrightarrow{f_0} k[i_1] \rightarrow \dots \xrightarrow{f_{n-1}} k[i_n] \xrightarrow{f_n} A.$$

The 0th face sends the factor $k[i_0]$ corresponding to (f_0, \dots, f_n) to the factor $k[i_1]$ corresponding to (f_1, \dots, f_n) by f_0 and the i th face ($i > 0$) sends the factor $k[i_0]$ corresponding to (f_0, \dots, f_n) to the factor $k[i_0]$ corresponding to $(f_1, \dots, f_i f_{i-1}, \dots, f_n)$ by the identity. Obviously the augmentation to A is simply the composite $f_n f_{n-1} \dots f_0$.

3.5.2 Lemma. *Any k -algebra A admits a free resolution and any two such resolutions are homotopy equivalent.*

Proof. The existence of a free resolution follows from 3.5.1.

Let P_* and Q_* be two such resolutions. One constructs a map $f_* : P_* \rightarrow Q_*$ by induction on the degree. It suffices to define f_n on the generators $x \in P_n$. Since Q_* is an acyclic simplicial module, it is a Kan complex (cf. Appendix B.9) with trivial homotopy. So there exists $y \in Q_n$ whose faces are $f_{n-1}(d_i x)$, $i = 0, \dots, n$. Then one puts $f_n(x) = y$. A similar argument shows that any other choice f'_* is homotopic to f_* . \square

3.5.3 The Cotangent Complex. Let P_* be a free resolution of A . By definition the *cotangent complex* of A is the complex $\mathbb{L}_*(A)$ deduced from P_* by

$$\mathbb{L}_n(A|k) = \Omega_{P_n|k}^1 \otimes_{P_n} A.$$

(In fact it is the class of \mathbb{L}_* in the derived category of complexes which should be called the cotangent complex. Hence the choice of a free resolution does not matter).

3.5.4 André-Quillen Homology of a Commutative Algebra. By definition *André-Quillen homology* of the commutative k -algebra A with coefficients in the A -module M is

$$D_n(A|k, M) := H_n(\mathbb{L}_*(A|k) \otimes_A M), \quad n \geq 0.$$

Other notations in the literature are $D_n(A/k, M)$ in Quillen [1970], $H_n(k, A, M)$ in André [1974]. If $M = A$ one simply writes $D_n(A|k)$ instead of $D_n(A|k, A)$.

One can also define *higher André-Quillen homology* $D^{(q)}$ for $q \geq 1$ by putting

$$D_n^{(q)}(A|k, M) := H_n(\mathbb{L}_*^{(q)}(A|k) \otimes_A M),$$

where $\mathbb{L}_n^{(q)}(A|k) = \Omega_{P_n|k}^q \otimes_{P_n} A$. So for $q = 1$ one has $D_n = D_n^{(1)}$.

André-Quillen cohomology is defined by

$$D^n(A|k, M) := H_{-n}(\text{Hom}_A(\mathbb{L}_*(A|k), M)).$$

It is immediate from Lemma 3.5.2 that any free resolution \mathbb{L}_* can be used to compute all these theories. Note that for $n = 0$, $D_0(A|k, M) = \Omega_{A|k}^1 \otimes_A M$ and $D^0(A|k, M) = \text{Der}_k(A, M)$.

3.5.5 Properties of AQ-Homology Theory. We will only state these properties and refer to Quillen [1970] or André [1974] for the proofs.

3.5.5.0 Homological Functors. Let $0 \rightarrow M' \rightarrow M \rightarrow M'' \rightarrow 0$ be an exact sequence of A -modules. Then there is a long exact sequence of homology groups

$$\begin{aligned} \dots \rightarrow D_{n+1}(A|k, M'') \rightarrow D_n(A|k, M') \rightarrow D_n(A|k, M) \\ \rightarrow D_n(A|k, M'') \rightarrow \dots \end{aligned}$$

3.5.5.1 Jacobi-Zariski Exact Sequence. Let $k \rightarrow K \rightarrow A$ be rings and homomorphisms of rings. Then there is a long exact sequence

$$\begin{aligned} \dots \rightarrow D_{n+1}(A|K) \rightarrow D_n(K|k) \otimes_K A \rightarrow D_n(A|k) \rightarrow D_n(A|K) \rightarrow \dots \\ \rightarrow \Omega_{K|k}^1 \otimes_K A \rightarrow \Omega_{A|k}^1 \rightarrow \Omega_{A|K}^1 \rightarrow 0. \end{aligned}$$

3.5.5.2 Flat Base Change. Let A and B be two k -algebras. If B is flat over k , then

$$D_*(A \otimes_k B|B, -) \cong D_*(A|k, -).$$

3.5.5.3 Localization. Let S be a multiplicative system in the ring A . Then $D_*(A_S|A) = 0$.

We stated these results in terms of D_* , however as usual they are just consequences of statements about the cotangent complex. For instance the localization property reads: $\mathbb{L}(A_S|A)$ is acyclic.

3.5.6 Theorem. *Suppose that A is smooth over k in the sense of hypothesis d) in 3.4.2. Then*

$$D_0(A|k, M) = M \otimes_A \Omega_{A|k}^1 \quad \text{and} \quad D_n(A|k, M) = 0 \quad \text{for} \quad n > 0.$$

More generally

$$D_0^{(q)}(A|k) = M \otimes_A \Omega_{A|k}^q \quad \text{and} \quad D_p^{(q)}(A|k) = 0 \quad \text{for } p > 0 .$$

Proof. This is an immediate consequence of the results of Sect. 2 (see also Appendix E). □

3.5.7 Comparison of AQ-Homology Theory with Hochschild Homology Theory. This relationship is given by the next theorem which is sometimes called the *fundamental spectral sequence for André-Quillen homology*. It leads to a decomposition of Hochschild homology in the rational case and to an HKR-type theorem under the smoothness assumption (d) of 3.4.2.

3.5.8 Theorem. *For any commutative and flat k -algebra A there is a canonical spectral sequence abutting to Hochschild homology:*

$$E_{pq}^2 = D_p^{(q)}(A|k) \Rightarrow HH_{p+q}(A) .$$

If k contains \mathbb{Q} this spectral sequence is degenerate and there is a canonical decomposition

$$HH_n(A) \cong \bigoplus_{p+q=n} D_p^{(q)}(A|k) .$$

Proof. Consider the following bicomplex \mathbb{L}_{**} :

$$\begin{array}{ccccccc}
 \downarrow & & \downarrow & & \downarrow & & \\
 L_0^{\otimes 3} & \leftarrow & L_1^{\otimes 3} & \leftarrow & L_2^{\otimes 3} & \leftarrow & \\
 b \downarrow & & -b \downarrow & & b \downarrow & & \\
 L_0^{\otimes 2} & \leftarrow & L_1^{\otimes 2} & \leftarrow & L_2^{\otimes 2} & \leftarrow & \\
 b \downarrow & & -b \downarrow & & b \downarrow & & \\
 L_0 & \leftarrow & L_1 & \leftarrow & L_2 & \leftarrow &
 \end{array}$$

where the bottom line is a simplicial resolution of A by free k -algebras. For q fixed the (horizontal) homology is $H_n(L_*^{\otimes q}) = 0$ if $n > 0$ and $H_0(L_*^{\otimes q}) = A^{\otimes q}$. Therefore $H_n(L_{**}) = HH_n(A)$. On the other hand for p fixed the (vertical) homology is $H_n(L_p^{\otimes *}) = HH_n(L_p) = \Omega_{L_p|k}^n$, since L_p is a symmetric algebra (cf. 3.2.2).

A consequence of these computations is the existence of a convergent spectral sequence

$$E_{pq}^2 = D_p^{(q)}(A|k) = H_q(\Omega_{L_*}^n) \Rightarrow HH_{p+q}(A|k) = HH_{p+q}(A) .$$

If k contains \mathbb{Q} , then there is a canonical projection from L_{**} to the bicomplex $\Omega_{L_*}^*$.

$$\begin{array}{ccccccc}
 & \downarrow & & \downarrow & & \downarrow & \\
 \Omega_{L_0}^2 & \leftarrow & \Omega_{L_1}^2 & \leftarrow & \Omega_{L_2}^2 & \leftarrow & \dots \\
 0 \downarrow & & 0 \downarrow & & 0 \downarrow & & \\
 \Omega_{L_0}^1 & \leftarrow & \Omega_{L_1}^1 & \leftarrow & \Omega_{L_2}^1 & \leftarrow & \dots \\
 0 \downarrow & & 0 \downarrow & & 0 \downarrow & & \\
 L_0 & \leftarrow & L_1 & \leftarrow & L_2 & \leftarrow & \dots
 \end{array}$$

inducing an isomorphism in homology. Since these complexes have isomorphic vertical homology groups, they have the same total homology. \square

3.5.9 Corollary. *Suppose that A is smooth over k in the sense of d) in 3.4.2. Then the antisymmetrization map ε is an isomorphism of algebras*

$$\Omega_{A|k}^* \cong HH_*(A).$$

Proof. It is now an immediate consequence of Theorems 3.5.6 and 3.5.8. \square

3.5.10 Comparison with Harrison Homology in Characteristic 0.
See Sect. 4.5.

Exercises

E.3.5.1. Let I be a commutative and not necessarily unital algebra over a field k of characteristic zero. Show that I is H -unital iff $D_*(k|I_+) = 0$. [Cf. Wodzicki [1989, Sect. 3.8].]

E.3.5.2. Let $k \rightarrow K \rightarrow A$ be rings and maps of rings such that A is flat over K . Show that the Jacobi-Zariski exact sequence for $D_* = D_*^{(1)}$ can be generalized to spectral sequences (one for each m):

$$E_{pq}^2 = \bigoplus_{i+j=m} D_p^{(i)}(K|k, D_q^{(j)}(A|K)) \Rightarrow D_{p+q}^{(m)}(A|k)$$

for higher André-Quillen theories. [If $L_n = k[I_n]$, $n \geq 0$, is a resolution of K over k , then choose a resolution of A over k of the form $k[I_n][J_n]$. Communicated by M. Ronco (unpublished).]

3.6 Deligne Cohomology

Deligne cohomology was constructed to understand a certain product on differential forms related to the Hodge filtration. This theory was later generalized into Deligne-Beilinson cohomology theory which is an efficient tool in the study of higher regulators. The reason for giving here a short account of Deligne cohomology is its close link with cyclic homology in the smooth case, and in particular in the comparison of the products. The main feature is that in Deligne cohomology the product on chains is commutative only up to homotopy, though in Connes' framework this product is *strictly* commutative on chains.

Standing Assumption. In this section the ground ring is the field \mathbb{C} of complex numbers.

3.6.1 Definition. We adopt the following notation: $\mathbb{Z}(1) := 2\pi i\mathbb{Z} \subset \mathbb{C}$ and $\mathbb{Z}(p) := \mathbb{Z}(1)^{\otimes p}$ for any $p > 0$. Let A be a commutative \mathbb{C} -algebra. The *Deligne complex* is by definition

$$\mathbb{Z}(p)_{\mathcal{D}}(A)^* : \mathbb{Z}(p) \rightarrow A \xrightarrow{d} \Omega_{A|\mathbb{C}}^1 \rightarrow \dots \rightarrow \Omega_{A|\mathbb{C}}^{p-1} \rightarrow 0 \rightarrow \dots ,$$

where $\mathbb{Z}(p)$ is in degree 0 (and so $\Omega_{A|\mathbb{C}}^{p-1}$ is in degree p). The inclusion of $\mathbb{Z}(p)$ in A is via \mathbb{C} .

By definition the *Deligne cohomology groups* of A are

$$H_{\mathcal{D}}^n(A, \mathbb{Z}(p)) := H^n(\mathbb{Z}(p)_{\mathcal{D}}(A)^*) , \quad H_{\mathcal{D}}^n(A) := \bigoplus_{p \geq 0} H_{\mathcal{D}}^n(A, \mathbb{Z}(p)) .$$

As in the case of de Rham homology, we should rather write $H_{\mathcal{D}}^n(X, \mathbb{Z}(p))$ with $X = \text{Spec}A$, the spectrum of A . In fact the definition of these groups can be extended to any algebraic variety X over \mathbb{C} by taking the hyperhomology of the complex of sheaves $\mathbb{Z}(p)_{\mathcal{D}}(\mathcal{O}_X)$. But we will only deal with the affine case in this book.

3.6.2 Product Structure on $H_{\mathcal{D}}^n(A, \mathbb{Z}(-))$. There is a product map of complexes

$$\cup : \mathbb{Z}(p)_{\mathcal{D}}^* \otimes \mathbb{Z}(q)_{\mathcal{D}}^* \rightarrow \mathbb{Z}(p+q)_{\mathcal{D}}^*$$

defined as follows. Let $\omega \in \mathbb{Z}(p)_{\mathcal{D}}^*$ and $\omega' \in \mathbb{Z}(q)_{\mathcal{D}}^*$, then

$$\omega \cup \omega' = \left\{ \begin{array}{ll} \omega\omega' & \text{if } n = 0, \forall m \text{ (then } \omega \text{ is a scalar),} \\ \omega \wedge d\omega' & \text{if } n = p, m = q, \\ 0 & \text{otherwise (i.e. } 0 < p < n, \forall m, \\ & \text{or } p = n \text{ and } m < q). \end{array} \right\} \in \mathbb{Z}(p+q)_{\mathcal{D}}^{n+m} .$$

Remark that for the middle case, i.e. $n = p$ and $m = q$, the result is also in the top dimension that is in $\mathbb{Z}(p+q)_{\mathcal{D}}^{p+q}$.

3.6.3 Proposition. *This product is associative and homotopy (graded) commutative. So it induces on Deligne cohomology a product*

$$\cup : H_{\mathcal{D}}^p(-, \mathbb{Z}(q)) \otimes H_{\mathcal{D}}^{p'}(-, \mathbb{Z}(q')) \rightarrow H_{\mathcal{D}}^{p+p'}(-, \mathbb{Z}(q + q'))$$

which is associative and (graded) commutative.

Proof. Associativity is strict and immediate to check.

Commutativity is not strict on cochains but only valid up to homotopy. The homotopy is explicitly given by

$$h(\omega \otimes \omega') = \begin{cases} 0 & \text{if } n = 0 \text{ and } m = 0, \\ (-1)^n \omega \wedge \omega' & \text{otherwise.} \end{cases}$$

We leave to the reader the straightforward task of checking that

$$(hd + dh)(\omega \otimes \omega') = \omega \cup \omega' - (-1)^{nm} \omega' \cup \omega . \quad \square$$

3.6.4 Reduced Deligne Cohomology. We call *reduced Deligne complex* the kernel of $\mathbb{Z}(p) \leftarrow \mathbb{Z}(p)_{\mathcal{D}}(A)^*$. It is simply the truncated de Rham complex shifted by one. It is immediate to check that it is endowed with a product structure as well. Its cohomology groups are denoted by $\tilde{H}_{\mathcal{D}}^p(A, \mathbb{Z}(q))$ (and more generally by $\tilde{H}_{\mathcal{D}}^p(X, \mathbb{Z}(q))$ for the hyperhomology of an algebraic variety). Obviously there is an exact sequence

$$\dots \rightarrow H^p(X, \mathbb{Z}(q)) \rightarrow \tilde{H}_{\mathcal{D}}^p(X, \mathbb{Z}(q)) \rightarrow H_{\mathcal{D}}^{p+1}(X, \mathbb{Z}(q)) \rightarrow H^{p+1}(X, \mathbb{Z}(q)) \rightarrow \dots$$

In the affine smooth case an immediate translation of Theorem 3.4.12 yields the following

3.6.5 Proposition. *If A is smooth over \mathbb{C} , then there is an isomorphism*

$$HC_{*-1}(A) \cong \bigoplus_{i \geq 0} \tilde{H}_{\mathcal{D}}^{*-2i}(A, \mathbb{Z}(* - i)) . \quad \square$$

3.6.6 Compatibility of Product Structures. In Sect. 4.4 we will show that for a commutative algebra A , $HC_*(A)[1]$ is endowed with a product structure, which is graded commutative. The point about the map of 3.6.5 is that it is an isomorphism of graded *algebras*. In fact it will be shown that “Sullivan’s commutative cochain problem” for the reduced Deligne complex is solved by Connes’ complex. Explicitly, the two quasi-isomorphisms of complexes

$$C^\lambda(A) \leftarrow \text{Tot } \mathcal{B}(A) \longrightarrow \text{Tot } \mathcal{D}(A)$$

(cf. 2.3.6) are compatible with the product structures on the three complexes. This product is commutative up to homotopy on the middle and right chain complexes, but is *strictly* commutative on the left chain complex, i.e. on $C^\lambda(A)$ (cf. 4.4.5).

Bibliographical Comments on Chapter 3

Most of the computations of Hochschild homology (or cohomology) groups given in this chapter have been known for a long time and can even be found in textbooks like Mac Lane [ML] and Cartan-Eilenberg [CE].

For cyclic homology, the case of a tensor algebra, done explicitly in Loday-Quillen [LQ], was hinted at in Hsiang-Staffeldt [1982] for the H^λ -theory. For almost symmetric algebras the proof is due to Kassel [1988b]. The case of universal enveloping algebras of Lie algebras has been done also by Feigin and Tsygan [1987b] by using Koszul duality of associative algebras. For smooth algebras the case of C^∞ -functions of manifolds was done by Connes [C], the algebraic case appeared in Loday-Quillen [LQ]. A generalization, with relationship to Grothendieck crystalline cohomology, is carried out in Feigin-Tsygan [1985]; this is strongly related with Sect. 6. André-Quillen cohomology was constructed and studied both in André [1974] and in Quillen [1970], generalizing work of Harrison [1962]. There are several papers devoted to this theory, see for instance Avramov-Halperin [1987]. For DG-algebras see Sect. 5.3, 5.4 and 5.BC. For group algebras see Sect. 7.4.

Many papers have been devoted to the computation of cyclic homology groups of specific algebras, especially in characteristic zero. See the list of references, which is close to completeness at the date of 1.1.1992.

Few computations have been done in positive characteristic apart from Gros [1987], and Wodzicki [1988c].

Chapter 4. Operations on Hochschild and Cyclic Homology

How does Hochschild and cyclic homology behave with respect to tensor products and with respect to operations performed on the defining complexes? This is the subject of the present chapter.

There are two types of operations which are taken up: those which come from A itself (conjugation and derivation) and those which come from the action of the symmetric group on the module of chains. It turns out that these latter operations are intimately related to the computation of cyclic homology of a tensor product of algebras. Some of them give rise to a splitting of HH and HC in the rational case.

In Sect. 4.1 we first analyze the action of conjugation by an invertible element. Then we turn to derivations. Any derivation D of the k -algebra A induces a map L_D on cyclic homology and the main theorem is the vanishing of the composite map $L_D \circ S$ where S is Connes periodicity map. This result is analogous to the homotopy invariance of the de Rham theory. An application to the computation of cyclic homology of nilpotent ideals is given.

In Sect. 4.2 we examine Hochschild homology of a tensor product of algebras. The Künneth theorem $HH_*(A) \otimes HH_*(A') \cong HH_*(A \otimes A')$ is induced by the shuffle product, which is studied in detail.

In Sect. 4.3 this result is extended to cyclic homology. Here the Künneth theorem is replaced by the Künneth exact sequence

$$\begin{aligned} \dots \rightarrow HC_*(A \otimes A') \rightarrow HC_*(A) \otimes HC_*(A') \\ \rightarrow HC_*(A) \otimes HC_*(A')[2] \rightarrow HC_{*-1}(A \otimes A') \rightarrow \dots \end{aligned}$$

Meanwhile a new product is constructed: the cyclic shuffle product. It permits us to construct in Sect. 4.4 a product on cyclic homology:

$$HC_p(A) \times HC_q(A') \rightarrow HC_{p+q+1}(A \otimes A')$$

which corresponds to the product $(\omega, \omega') \mapsto \omega \wedge d\omega'$ on forms (as in Deligne cohomology). There also exists a coproduct, which, once translated into the cohomological framework, gives rise to a product

$$HC^p(A) \times HC^q(A') \rightarrow HC^{p+q}(A \otimes A') .$$

Sections 4.5 and 4.6 are devoted to the λ -decomposition of Hochschild and cyclic homology respectively:

$$HH_n = HH_n^{(1)} \oplus \dots \oplus HH_n^{(n)}, \quad \text{and} \quad HC_n = HC_n^{(1)} \oplus \dots \oplus HC_n^{(n)}.$$

These splittings are consequences of the existence of the Eulerian idempotents $e_n^{(i)} \in \mathbb{Q}[S_n]$, $1 \leq i \leq n$, which behave fantastically well with respect to the Hochschild and Connes boundary maps. These idempotents are related to interesting combinatorial formulas involving the classical Eulerian numbers. The pieces $HH_n^{(1)}$ and $HC_n^{(1)}$ of the decomposition are shown to be related to Harrison-André-Quillen theory and the pieces $HH_n^{(n)}$ and $HC_n^{(n)}$ to differential forms. As for the intermediate pieces, they coincide with de Rham cohomology in the smooth case. Work remains to be done to understand them in the general case.

4.1 Conjugation and Derivation

In this section we show how conjugation and derivation act on Hochschild and cyclic homology. Conjugation by an invertible element acts as the identity. Similarly an inner derivation induces 0. For an arbitrary derivation D the action L_D on cyclic homology is such that $L_D \circ S = 0$. These results were essentially known by G. Rinehart and rediscovered later by several people including A. Connes and T. Goodwillie.

4.1.1 Conjugation. Let A^\times be the group of invertible elements of the unital k -algebra A . Any $g \in A^\times$ induces an action on $M \otimes A^{\otimes n}$ called *conjugation* and defined by

$$g.(m, a_1, \dots, a_n) = (gmg^{-1}, ga_1g^{-1}, \dots, ga_n g^{-1}).$$

This map obviously commutes with the Hochschild boundary and, when $M = A$, with the cyclic operator (it is even an endomorphism of cyclic module). Therefore it induces an endomorphism, denoted g_* , of Hochschild and cyclic homology.

4.1.2 Proposition. *The endomorphism g_* of $H_n(A, M)$ is the identity.*

Proof. The maps $h_i : M \otimes A^{\otimes n} \rightarrow M \otimes A^{\otimes n+1}$, $i = 0, \dots, n$, where

$$h_i(m, a_1, \dots, a_n) = (mg^{-1}, ga_1g^{-1}, \dots, ga_i g^{-1}, g, a_{i+1}, \dots, a_n)$$

define a simplicial homotopy h since the formulas of 1.0.8 are fulfilled with $d_0 h_0 = id$ and $d_{n+1} h_n = g.(-)$. Hence the proposition is a consequence of 1.0.9.

A slightly different proof is given in the proof of the next proposition. \square

4.1.3 Proposition. *The endomorphism g_* of $HC_*(A)$ (resp. $HC_*^{\text{per}}(A)$, resp. $HC_*^-(A)$) is the identity.*

Proof. Consider the following commutative diagram, where inc_1 (resp. inc_2) sends the element a to $\begin{bmatrix} a & 0 \\ 0 & 0 \end{bmatrix}$ (resp. $\begin{bmatrix} 0 & 0 \\ 0 & a \end{bmatrix}$):

$$\begin{array}{ccccc}
 A & \xrightarrow{\text{inc}_1} & \mathcal{M}_2(A) & \xleftarrow{\text{inc}_2} & A \\
 \downarrow \text{id} & & \downarrow \begin{bmatrix} 1 & 0 \\ 0 & g \end{bmatrix} & & \downarrow g \\
 A & \xrightarrow{\text{inc}_1} & \mathcal{M}_2(A) & \xleftarrow{\text{inc}_2} & A
 \end{array}$$

Let F be one of the following functors: HH_* , HC_* , HC_*^{per} , HC_*^- (see Sect. 5.1 for these last two functors). By Morita invariance the maps $F(\text{inc}_1)$ and $F(\text{inc}_2)$ are isomorphisms. Since the trace map tr induces an inverse to inc_1 on homology (cf. 1.2.4 and 2.2.9) and since $\text{tr} \circ \text{inc}_2 = \text{id}$, one has

$$F(\text{inc}_1)^{-1} \circ F(\text{inc}_2) = F(\text{tr} \circ \text{inc}_2) = \text{id} .$$

Therefore $F(g_*) = (F(\text{inc}_1)^{-1} \circ F(\text{inc}_2))^{-1} \circ F(\text{id}) \circ (F(\text{inc}_1)^{-1} \circ F(\text{inc}_2)) = \text{id}$. □

4.1.4 Action of Derivations on HH and HC . Recall that a *derivation* of A (into itself) is a k -linear map $D : A \rightarrow A$ such that $D(ab) = (Da)b + a(Db)$ (cf. 1.3.1 and 1.5.2). For any $u \in A$ the map $\text{ad}(u) : A \rightarrow A$, $\text{ad}(u)(a) = [u, a]$ is a derivation called an *inner derivation*. Any derivation D can be extended to $C_n(A) = A^{\otimes n+1}$ by the formula

$$L_D(a_0, \dots, a_n) = \sum_{i \geq 0} (a_0, \dots, a_{i-1}, Da_i, a_{i+1}, \dots, a_n) .$$

The relation satisfied by D implies immediately that $L_D : C_n(A) \rightarrow C_n(A)$ commutes with the operators d_i , s_j and t (for instance $L_D d_0(a_0, a_1) = L_D(a_0 a_1) = D(a_0 a_1) = (Da_0)a_1 + a_0(Da_1) = d_0((Da_0, a_1) + (a_0, Da_1)) = d_0 L_D(a_0, a_1)$). In other words L_D is a morphism of cyclic modules. Therefore L_D commutes with b and B . So there are induced maps on the Hochschild complex and on the bicomplex $\mathcal{B}(A)$, which induce

$$L_D : HH_n(A) \rightarrow HH_n(A) \quad \text{and} \quad L_D : HC_n(A) \rightarrow HC_n(A) , \quad n \geq 0 .$$

4.1.5 Proposition. *If $D = \text{ad}(u)$ is an inner derivation, then L_D is 0 on Hochschild and on cyclic homology.*

Proof. It was proved in 1.3.3 that any $u \in A$ determines a map $h(u) : C_n \rightarrow C_{n+1}$ such that $bh(u) + h(u)b = -\text{ad}(u)$. It is immediate to check that, in the normalized framework, $Bh(u) + h(u)B = 0$ since $[u, 1] = 0$. Hence, by putting $h(u)$ on each column of $\mathcal{B}(A)$, we define a homotopy from $\text{ad}(u)$ to 0 on $\text{Tot } \mathcal{B}(A)$, whence the result. □

4.1.6 Corollary. *There are well-defined homomorphisms of Lie algebras $[D] \mapsto L_D$:*

$$H^1(A, A) \rightarrow \text{End}_k(HH_n(A)) \quad \text{and} \quad H^1(A, A) \rightarrow \text{End}_k(HC_n(A)).$$

Proof. Since $H^1(A, A) = \text{Der}(A)/\{\text{inner derivations}\}$, (cf. 1.5.2), Proposition 4.1.5 implies that both maps are well-defined.

The Lie algebra structure of $\text{End}_k(-)$ is given by $[f, f'] = f \circ f' - f' \circ f$. The Lie algebra structure of $H^1(A, A)$ is similar and described in 1.5.2. The fact that $[D] \mapsto L_D$ is a Lie algebra homomorphism follows from $L_D \circ L_{D'} - L_{D'} \circ L_D = L_{[D, D']}$, which is a straightforward check at the chain level (i.e. on $C_n(A)$). \square

4.1.7 Lifting of the Interior Product: the Operators e_D and E_D . In the framework of differential forms, any vector field X determines a derivation ∂_X and an interior product i_X satisfying the formula

$$\partial_X = di_X + i_X d.$$

Our aim is to show that for any derivation D there is an operator e_D of degree -1 which plays the role of the interior product (cf. 4.1.9). To compare its behavior with respect to Connes' boundary map it is necessary to introduce an operator E_D of degree $+1$ as follows.

Let D be a derivation of A . By definition

$$e_D : A \otimes \bar{A}^{\otimes n} \rightarrow A \otimes \bar{A}^{\otimes n-1} \quad \text{and} \quad E_D : A \otimes \bar{A}^{\otimes n} \rightarrow A \otimes \bar{A}^{\otimes n+1}$$

are given by the following formulas:

$$\begin{aligned} e_D(a_0, \dots, a_n) &:= (-1)^{n+1} (D(a_n) a_0, a_1, \dots, a_{n-1}), \\ E_D(a_0, \dots, a_n) &:= \\ &\sum_{1 \leq i \leq j \leq n} (-1)^{in+1} (1, a_i, a_{i+1}, \dots, a_{j-1}, D a_j, a_{j+1}, \dots, a_n, a_0, \dots, a_{i-1}). \end{aligned}$$

Remark that both maps are linear in D .

4.1.8 Proposition. *The following formulas are valid on the normalized complex $\bar{C}_*(A)$:*

$$(4.1.8.1) \quad [e_D, b] = 0,$$

$$(4.1.8.2) \quad [e_D, B] + [E_D, b] = L_D,$$

$$(4.1.8.3) \quad [E_D, B] = 0.$$

Proof. Here, the commutators are understood as graded commutators, so $[e_D, b] = e_D b + b e_D$ and similarly for the other ones.

The third formula is immediate since we are working in the normalized framework.

The first formula is proved as follows. From the definition of e_D and b it is easy to check that

$$(e_D b + b e_D)(a_0, \dots, a_n) = (a_{n-1} D a_n a_0, a_1, \dots, a_{n-2}) \\ - (D(a_{n-1} a_n) a_0, a_1, \dots, a_{n-2}) + (D a_{n-1} a_n a_0, a_1, \dots, a_{n-2}).$$

Hence the equality follows from the fact that D is a derivation.

The second formula is a little work. To ease the proof we write i instead of a_i and therefore Di instead of Da_i . To avoid confusion we write $*$ instead of 1.

Applied to $(0, \dots, n)$ the operator $e_D B + B e_D + E_D b + b E_D$ is a sum of elements of two different kinds: those with a $*$ as the first entry, and the others. First we take care of the second kind.

They come from $e_D B$ and $b E_D$:

$$e_D B(0, \dots, n) = e_D \sum_{i=0}^n (-1)^{in} (*, i, \dots, i-1) \\ = (-1)^{n+2} \sum_{i=0}^n (-1)^{in} (D(i-1), i, \dots, i-2).$$

The elements of the second kind in $b(*, 0, \dots, n)$ are

$$(0, \dots, n) + (-1)^{n+1} (n, 0, \dots, n-1).$$

So, after simplification, the elements of the second kind in $b E_D(0, \dots, n)$, which contain Dj for some fixed j ($1 \leq j \leq n$), are $(0, \dots, Dj, \dots, n) + (-1)^{jn+1} (Dj, \dots, j-1)$. Summing over j all the elements coming from $e_D B$ and $b E_D$ give $\sum_{j=0}^n (0, \dots, Dj, \dots, n)$ which is precisely $L_D(0, \dots, n)$.

It is sufficient now to prove that the elements of the first kind amount to zero. They appear in $B e_D$, $E_D b$ and $b E_D$ (“interior” part). We will prove that the elements coming from $B e_D + E_D b$ cancel with those coming from $b E_D$. First, the elements of $b E_D(0, \dots, n)$ which have $(Dn)0$ as entry cancel with the elements of $B e_D(0, \dots, n)$. Secondly, an element like $(*, i, \dots, k(k+1), \dots, Dj, \dots)$ coming from $b(*, i, \dots, Dj, \dots)$ cancels with one in $E_D b(0, \dots, n)$ coming from $E_D d_k(0, \dots, n)$. Finally, elements of the form $(*, i, \dots, (j-1)Dj, \dots)$ and $(*, i, \dots, (Dj)(j-1), \dots)$ come from $(*, i, \dots, D(j(j-1)), \dots)$ in $E_D b(0, \dots, n)$. So we have proved that the sum of the elements of the first kind is 0 and this finishes the proof. \square

4.1.9 Corollary. *For any derivation D the map e_D is well-defined on $HH_*(A)$ and satisfies $[e_D, B_*] = L_D$.*

4.1.10 Theorem. $L_D \circ S = 0 : HC_*(A) \rightarrow HC_{*-2}(A)$.

Proof. The map $S : \overline{B}_*(A) \rightarrow \overline{B}_*(A)[2]$ sends the first column to 0 and is an isomorphism on the others (cf. 2.2.2). Formulas of Proposition 4.1.8 show that the matrix

$$\begin{bmatrix} e & E & 0 & & \\ & e & E & 0 & \\ & & e & E & \cdot \\ & & & \cdot & \cdot \\ & & & & \cdot \end{bmatrix}$$

is a homotopy from $\text{Tot}(L_D \circ S)$ to 0. □

4.1.11 Corollary. $L_D = 0$ on periodic cyclic homology HC_*^{per} (cf. Sect. 5.1 for the definition of periodic cyclic homology).

Proof. In periodic cyclic homology the boundary is $b + B$, so the equality $[e_D + E_D, B + b] = L_D$ means that $e_D + E_D$ is a homotopy from L_D to 0. Therefore $L_D = 0$ on HC_*^{per} . □

4.1.12 Application to Cyclic Homology of Graded Algebras. In this subsection k is supposed to contain \mathbb{Q} . Suppose that A is a unital non-negatively graded algebra, that is $A = A_0 \oplus A_1 \oplus A_2 \oplus \dots$ where the product sends $A_i \otimes A_j$ into A_{i+j} (and $1 \in A_0$). Let us call $n = |a|$ the weight of $a \in A_n$. Since the weight $\sum |a_i|$ of $(a_0, \dots, a_n) \in A^{\otimes n+1}$ is unchanged by b and B , the groups $HC_n(A)$ split naturally according to the weight.

There is a natural derivation on A given by $Da = |a|a$ on homogeneous elements. It is clear that L_D is multiplication by w on the piece of weight w . So, by Theorem 4.1.10, S is 0 on $HC_n(A)/HC_n(A_0)$. Finally we have proved the following

4.1.13 Theorem. Let A be a unital graded algebra over k containing \mathbb{Q} . Define $\tilde{HC}_n(A) := HC_n(A)/HC_n(A_0)$ and $\tilde{HH}_n(A) := HH_n(A)/HH_n(A_0)$. Connes' exact sequence for \tilde{HC} reduces to the short exact sequences:

$$0 \rightarrow \tilde{HC}_{n-1} \rightarrow \tilde{HH}_n \rightarrow \tilde{HC}_n \rightarrow 0.$$

Another useful application of the vanishing of $L_D S$ on relative cyclic homology is the following result due to T. Goodwillie.

4.1.14 Theorem. Let A be a unital k -algebra and I a two-sided nilpotent ideal of A ($I^{m+1} = 0$). Then the map $p!S^p : HC_{n+2p}(A, I) \rightarrow HC_n(A, I)$ on relative cyclic homology is trivial for $p > m(n + 1)$.

Proof. Filter A by the powers of I :

$$A = I^0 \supset I^1 \supset I^2 \supset \dots \supset I^m \supset I^{m+1} = 0.$$

There is defined a decreasing filtration on $C(A)$ as follows:

$$F_n^p = \sum_{p_0 + \dots + p_n \geq p} I^{p_0} \otimes \dots \otimes I^{p_n} \subset A^{\otimes n+1} = C_n(A).$$

Note that $F_n^0 = C_n(A)$ and that $F_n^{m(n+1)+1} = 0$. Remark that F^p is a cyclic module for all $p \geq 0$ and that $HC_*(A, I) = HC_*(F^1)$.

First Step. Let us prove that the map S is 0 on $HC_*(F^p/F^{p+1})$ for $p > 0$. As a cyclic module $\bigoplus_{p \geq 0} F^p/F^{p+1}$ is isomorphic to $C(\text{gr}(A))$, where $\text{gr}(A)$ is the graded algebra of A associated to the filtration by the powers of I . On $\text{gr}(A)$ there is defined a derivation D given by $Da = pa$ for $a \in \text{gr}_p(A) = I^p/I^{p+1}$. By Theorem 4.1.10 pS is 0 on $HC_*(\text{gr}_p(A))$.

As a consequence $p!S^p$ is 0 on $HC_*(F^1/F^{p+1})$ (cf. Exercise E.1.0.1).

Second Step. The nilpotency of I implies that $F_n^p = 0$ for $p > m(n+1)$. Therefore $HC_n(F^p) = 0$ and $HC_n(F^1) \rightarrow HC_n(F^1/F^{p+1})$ is injective in the same range.

Combining the results of the two steps, it comes out that

$$p!S^p : HC_{n+2p}(F^1) \rightarrow HC_n(F^1)$$

is 0 provided that $p > m(n+1)$. □

4.1.15 Corollary. *Suppose that k contains \mathbb{Q} and let I be a nilpotent ideal of A . Then $HC_*^{\text{per}}(A, I) = 0$ and therefore the maps $B : HC_{*-1}(A, I) \rightarrow HC_*^-(A, I)$ and $HC_*^{\text{per}}(A) \rightarrow HC_*^{\text{per}}(A/I)$ are isomorphisms. □*

(For the definition of periodic cyclic homology see Sect. 5.1)

Exercises

E.4.1.1. Let $D : A \rightarrow A$ be a k -linear map. Show that the map $L_D : C_n(A) \rightarrow C_n(A)$ of 4.1.4 is simplicial if and only if D is a derivation.

E.4.1.2. Let $D : A \rightarrow A$ be a derivation. Show that there is one and only one map $C(A) \rightarrow C(A)$ compatible with the coalgebra structure of $C(A)$ and which coincides with D in degree 0.

E.4.1.3. Let D and D' be two derivations of A . Show that $[L_D, e_{D'}] = e_{[D, D']}$ (cf. Rinehart [1963, p. 219]).

E.4.1.4. Show that the product $H^1(A, A) \times HH_p(A) \rightarrow HH_p(A)$ of 4.1.6 can be extended to a product

$$H^n(A, A) \times HH_p(A) \rightarrow HH_{p-n+1}(A)$$

so that $HH_*(A)$ becomes a graded Lie module over the graded Lie algebra $H^*(A, A)[1]$ (cf. Exercise E.1.5.2).

E.4.1.5. Let I be a sub-algebra of A which is H -unital. Let $g \in A^\times$ be such that $gI \subset I$ and $Ig^{-1} \subset I$. Show that g_* is well-defined on $HH_*(I)$ and $HC_*(I)$, and is equal to the identity (cf. Wodzicki [1989]).

E.4.1.6. Suppose that k contains \mathbb{Q} . Let A and B be unital algebras and M an A - B -bimodule. Let

$$T = \begin{bmatrix} A & M \\ 0 & B \end{bmatrix}$$

be the triangular matrix algebra. Show that $HH_*(T) = HH_*(A) \oplus HH_*(B)$ by using derivations. [Use $ad(u)$ for $u = \begin{bmatrix} 1 & 0 \\ 0 & 0 \end{bmatrix}$.]

E.4.1.7. Show that L_D acts trivially on non-commutative de Rham homology (see 2.6.6).

E.4.1.8. Truncated Polynomial Rings. Let $A = k[x]/x^{r+1}$ be a truncated polynomial ring over k . We denote by ${}_n k$ and k/nk the kernel and cokernel of the multiplication by n respectively. Show that

$$\begin{aligned} HH_0(A) &= A \cong k^{r+1}, \\ HH_{2n-1}(A) &\cong k^r \oplus k/(r+1)k, \\ HH_{2n}(A) &= k^r \oplus_{r+1} k, \quad n > 0. \end{aligned}$$

If k contains \mathbb{Q} show that

$$\begin{aligned} HC_0(A) &= A \cong k^{r+1}, \\ HC_{2n-1}(A) &= 0, \\ HC_{2n}(A) &\cong k^{r+1}, \quad n > 0. \end{aligned}$$

[For the computation of HH use the resolution

$$\dots \xrightarrow{P(y,z)} Q \xrightarrow{y-z} Q \xrightarrow{P(y,z)} \dots \xrightarrow{y-z} Q \rightarrow A,$$

where $Q = k[y, z]/y^{r+1} = z^{r+1} = 0$ and $P(y, z)(y - z) = y^{r+1} - z^{r+1}$. For the computation of HC apply Theorem 4.1.13. See also the end of Sect. 5.4.]

4.2 Shuffle Product in Hochschild Homology

The notion of shuffle comes naturally when one tries to decompose a product of geometric simplices into a union of other simplices. In algebra the shuffle product was introduced by Eilenberg and Mac Lane. It induces a product on Hochschild homology and yields the Eilenberg-Zilber theorem which shows that Hochschild homology commutes with tensor product. On differential forms the shuffle product induces the exterior product of forms.

4.2.1 The Shuffle Product. Let S_n be the symmetric group acting on the set $\{1, \dots, n\}$. A (p, q) -shuffle is a permutation σ in S_{p+q} such that

$$\sigma(1) < \sigma(2) < \dots < \sigma(p) \quad \text{and} \quad \sigma(p+1) < \sigma(p+2) < \dots < \sigma(p+q).$$

For any k -algebra A we let S_n act on the left on $C_n = C_n(A) = A \otimes A^{\otimes n}$ by:

$$(4.2.1.1) \quad \sigma.(a_0, a_1, \dots, a_n) = (a_0, a_{\sigma^{-1}(1)}, a_{\sigma^{-1}(2)}, \dots, a_{\sigma^{-1}(n)}) .$$

In other words, if σ is a (p, q) -shuffle the elements $\{a_1, a_2, \dots, a_p\}$ appear in the same order in the sequence $\sigma.(a_0, \dots, a_n)$ and so do the elements $\{a_{p+1}, a_{p+2}, \dots, a_{p+q}\}$.

Let A' be another k -algebra. The *shuffle product*

$$- \times - = sh_{pq} : C_p(A) \otimes C_q(A') \rightarrow C_{p+q}(A \otimes A')$$

is defined by the following formula:

$$(4.2.1.2) = \sum_{\sigma} \text{sgn}(\sigma) \sigma.(a_0 \otimes a'_0, a_1 \otimes 1, \dots, a_p \otimes 1, 1 \otimes a'_1, \dots, 1 \otimes a'_q),$$

where the sum is extended over all (p, q) -shuffles. This is in fact the formula of Lemma 1.6.11 made explicit in this particular case. Remark that this formula is well-defined in the normalized setting since if $a_i = 1$ for some $i > 1$ (resp. $a'_i = 1$ for some $i > 1$) then $a_i \otimes 1$ (resp. $1 \otimes a'_i$) = $1 \otimes 1$ is the identity of $A \otimes A'$. We think of $sh_{p,q} = \sum \text{sgn}(\sigma) \sigma$ either as an element in $\mathbb{Z}[S_n]$ or as a map (see above) depending on the context.

Note that the same formula defines more generally a shuffle product from

$$C_p(A, M) \otimes C_q(A', M') \quad \text{to} \quad C_{p+q}(A \otimes A', M \otimes M').$$

4.2.2 Proposition. *The Hochschild boundary is a graded derivation for the shuffle product:*

$$b(x \times y) = b(x) \times y + (-1)^{|x|} x \times b(y), \quad x \in C_p \quad \text{and} \quad y \in C'_q .$$

Proof. Let $x = (a_0, a_1, \dots, a_p)$ and $y = (a'_0, a'_1, \dots, a'_q)$, and write $x \times y = \sum \pm(c_0, c_1, \dots, c_{p+q})$. The element c_0 is $a_0 \otimes a'_0$ and for $i > 0$ the element c_i is either in the first set $\{a_1 \otimes 1, \dots, a_p \otimes 1\}$ or in the second set $\{1 \otimes a'_1, \dots, 1 \otimes a'_q\}$. Fix i , $0 \leq i \leq n$, and consider the element $d_i(c_0, c_1, \dots, c_{p+q})$ appearing in the expansion of $b(x \times y)$. If c_i and c_{i+1} are in the first (resp. second) set, or if $i = 0$ and c_1 is in the first (resp. second) set, or if $i = n$ and c_n is in the first (resp. second) set, then $d_i(c_0, c_1, \dots, c_{p+q})$ appears also in the expansion of $b(x) \times y$ (resp. $x \times b(y)$) and conversely. If c_i and c_{i+1} belong to two different sets, then $(c_0, c_1, \dots, c_{i-1}, c_{i+1}, c_i, c_{i+2}, \dots, c_{p+q})$ is also a shuffle and so appears in the expansion of $x \times y$. As its sign is the opposite of the sign (in front) of $(c_0, c_1, \dots, c_{p+q})$, these two elements cancel after applying d_i (because $c_i c_{i+1} = c_{i+1} c_i$).

By the end we have proved that

$$b(x \times y) = b(x) \times y + (-1)^p x \times b(y)$$

(checking that the signs are correct is left to the reader).

This is an elementary and combinatorial proof. For a more conceptual proof (proving associativity as well) see Mac Lane [ML, p. 312]. \square

4.2.3 The Shuffle Product Map. Let

$$sh : (C_*(A) \otimes C_*(A'))_n = \bigoplus_{p+q=n} C_p(A) \otimes C_q(A') \rightarrow C_n(A \otimes A')$$

be the sum of the shuffle product maps sh_{pq} for $p + q = n$. This is the map described in 1.6.11 for the simplicial modules $C(A)$ and $C(A')$ once $C(A) \times C(A')$ is identified with $C(A \otimes A')$. See 4.2.8 for an explicit description in the commutative case.

4.2.4 Proposition. *The map $sh : C_*(A) \otimes C_*(A') \rightarrow C_*(A \otimes A')$ is a map of complexes of degree 0, that is $[b, sh] = 0$.*

Proof. This follows readily from Proposition 4.2.2. \square

4.2.5 Theorem. (Künneth formula for Hochschild Homology). *Suppose that A' and $HH_*(A')$ are flat over k (e.g. k is a field). Then the shuffle map induces an isomorphism*

$$sh_* : HH_*(A) \otimes HH_*(A') \cong HH_*(A \otimes A') .$$

Proof. Cf. Mac Lane [ML, Chap. 8, Theorem 8.1] or Cartan-Eilenberg [CE, p. 218–219]. \square

4.2.6 The Case of a Commutative Algebra. Suppose that A is commutative. Then the product map $\mu : A \otimes A \rightarrow A$ is a k -algebra homomorphism.

Composing the shuffle product with the map induced by μ gives an *inner shuffle product map*:

$$- \times - = sh_{pq} : C_p(A) \otimes C_q(A) \rightarrow C_{p+q}(A) ,$$

$$\begin{aligned} (a_0, a_1, \dots, a_p) \times (a'_0, a_{p+1}, \dots, a_{p+q}) \\ = \sum_{\sigma=(p,q)\text{-shuffle}} \text{sgn}(\sigma)\sigma. (a_0 a'_0, a_1, \dots, a_{p+q}) . \end{aligned}$$

Remark that this map is well-defined even if A has no unit. So, equipped with the shuffle product, $C(A)$ becomes a graded algebra. In fact Proposition 4.2.2 implies that it is a *DG*-algebra.

4.2.7 Corollary. *When A is commutative the shuffle product*

$$\times : HH_p(A) \otimes HH_q(A) \rightarrow HH_{p+q}(A)$$

induces on $HH_(A)$ a structure of graded commutative algebra.* □

4.2.8 The *sh* Map. The multiplication on the first variable makes $C_p(A) = A \otimes A^{\otimes p}$ into an A -module and it is immediate to check that \times passes to the tensor product over A :

$$\times : C_p(A) \otimes_A C_q(A) \rightarrow C_{p+q}(A) .$$

Identify $C_p(A) \otimes_A C_q(A)$ with $C_{p+q}(A)$ by

$$(a_0, \dots, a_p) \otimes_A (a'_0, \dots, a'_q) = (a_0 a'_0, a_1, \dots, a_p, a'_1, \dots, a'_q)$$

and still denote by $sh_{p,q}$ the resulting endomorphism of $C_{p+q}(A)$. By definition

$$sh = \sum_{\substack{p+q=n \\ p \geq 1, q \geq 1}} sh_{p,q} : C_n(A) \rightarrow C_n(A) .$$

This map sh is in fact the action of the element $sh = \sum \text{sgn}(\sigma)\sigma \in k[S_n]$, where the sum is extended over all (p, q) -shuffles, $p + q = n$ and $p \geq 1, q \geq 1$.

Proposition 4.2.3 implies that, in this setting, we have the formula

$$(4.2.8.1) \quad [b, sh] = 0 .$$

In other words sh is a morphism of complexes.

4.2.9 Shuffle Product and Differential Forms. For $p = q = 0$ the shuffle product reduces to the product map $\mu : A \otimes A \rightarrow A$. For $p = 0$ it gives the A -module structure on Hochschild homology (cf. 1.1.5). For $p = q = 1$ the map $\Omega^1_{A|k} \otimes \Omega^1_{A|k} \rightarrow HH_2(A)$ factors through $\Omega^2_{A|k}$ (cf. 1.3.12), via $(adb) \otimes (a'db') \mapsto aa'dbdb'$. More generally the iteration of the product map defines a map

$$\Omega_{A|k}^n = \Lambda_A^n \Omega_{A|k}^1 = \Lambda_A^n(HH_1(A)) \rightarrow HH_n(A),$$

which is precisely the antisymmetrization map ε_n described in 1.3.4, since in terms of permutations it is given by

$$\varepsilon_n(a_0 da_1 \dots da_n) = \sum_{\sigma \in S_n} \text{sgn}(\sigma) \sigma \cdot (a_0, a_1, \dots, a_n).$$

As a consequence there is a commutative diagram

$$\begin{array}{ccc} \Omega^p \times \Omega^q & \xrightarrow{\varepsilon_p \times \varepsilon_q} & HH_p \times HH_q \\ \wedge \downarrow & & \downarrow \times \\ \Omega^{p+q} & \xrightarrow{\varepsilon_{p+q}} & HH_{p+q} \end{array}$$

where \wedge is the exterior product of forms. In other words $\Omega_{A|k}^* \rightarrow HH_*(A)$ is an algebra homomorphism (even an iso when A is smooth, cf. Sect. 3.4).

4.2.10 Harrison Homology. The Hochschild complex $C(A)$ of the commutative k -algebra A is a CDG -algebra which is augmented over A . Its product is the shuffle product. Let $I = \bigoplus_{n>0} C_n(A)$ be the augmentation ideal. For any A -module M , $C(A, M)$ is a $C(A)$ -module. It follows from Proposition 4.2.2 that the quotient $C(A, M)/I \cdot C(A, M)$ is a well-defined complex. By definition its homology is *Harrison homology* and is denoted

$$\text{Harr}_n(A, M) := H_n(C(A, M)/I \cdot C(A, M)).$$

4.2.11 Proposition. *If A is flat over k containing \mathbb{Q} , then Harrison homology is canonically isomorphic to André-Quillen homology (cf. Sect. 3.5):*

$$\text{Harr}_n(A, M) \cong D_{n-1}(A|k, M).$$

Proof. Let L_* be a free simplicial resolution of the k -algebra A . For i fixed, the quasi-isomorphism $C(L_i) \rightarrow \Omega_{L_i|k}^*$ sends the shuffle product into the exterior product. The proof of Theorem 3.5.8 implies that the complex $C(L_i)/I_i \cdot C(L_i)$ (with $I_i =$ augmentation ideal of $C(L_i)$) is quasi-isomorphic to the short complex

$$\dots \rightarrow 0 \rightarrow 0 \rightarrow \Omega_{L_i|k}^* \xrightarrow{0} L_i.$$

By the same argument as in 3.5.8 we conclude that $\text{Harr}_n(A, M)$ is isomorphic to $D_{n-1}(A|k, M)$ for $n \geq 1$. □

Exercises

E.4.2.1. Let A be a commutative k -algebra and D a derivation of A . Show that L_D is a (graded) derivation of the graded algebra $HH_*(A)$.

E.4.2.2. Show that on the bar resolution C_*^{bar} the product

$$(x_0, \dots, x_{p+1}) \otimes (y_0, \dots, y_{q+1}) \mapsto \sum \pm(x_0 y_0, z_1, \dots, z_{p+q}, x_{p+1} y_{q+1})$$

where the sum is extended over all (p, q) -shuffles (z_1, \dots, z_{p+q}) of $(x_1, \dots, x_p, y_1, \dots, y_q)$, induces the structure of a graded commutative algebra (here A is commutative). Show that it induces the standard shuffle product on $HH_*(A)$ and a coproduct on $H^*(A, A)$.

E.4.2.3. Let $A[\varepsilon]$ be the algebra of dual numbers ($\varepsilon^2 = 0$) over A . Show that $D : A \rightarrow A$ is a derivation if and only if $\tilde{D} : A \rightarrow A[\varepsilon]$ given by $\tilde{D}(a) = a + \varepsilon D(a)$ is a k -algebra map. Use the computation of $HH_*(A[\varepsilon])$ to give an alternative definition of L_D on HH and to show that this map commutes with the shuffle product.

E.4.2.4. Show there is a product on the complex $(C_*(A), b')$ such that $(1-t) : (C_*(A), b) \rightarrow (C_*(A), b')$ becomes a derivation. Extend the existence of a product to Hochschild homology of non-unital algebras (cf. 1.4.5).

$$\left[\begin{array}{l} \text{Take } ((a_1, \dots, a_p), (a_{p+1}, \dots, a_{p+q})) \\ \mapsto \sum_{\sigma=(p,q)\text{-shuffle}} (a_{\sigma^{-1}(1)}, a_{\sigma^{-1}(2)}, \dots, a_{\sigma^{-1}(p+q)}) \end{array} \right]$$

4.3 Cyclic Shuffles and Künneth Sequence for HC

In this section we show how to compute the cyclic homology of a tensor product of algebras. Unlike what happens for Hochschild homology, it does not yield an isomorphism but rather a long exact sequence, called the Künneth sequence, similar to Connes' exact sequence:

$$\begin{aligned} \dots \rightarrow HC_*(A \otimes A') \rightarrow HC_*(A) \otimes HC_*(A') \\ \rightarrow HC_*(A) \otimes HC_*(A')[2] \rightarrow HC_{*-1}(A \otimes A') \rightarrow \dots \end{aligned}$$

This similarity can be explained by thinking of the topological analogue (cf. introduction of Sect. 2.2). Let X and X' be two S^1 -spaces and consider $X \times X'$ as an S^1 -space by the diagonal action. Then $H_*(X \times X'/S^1)$ plays the role of $HC_*(A \otimes A')$. Since there are two S^1 -actions on $X \times X'$, the quotient $X \times X'/S^1$ is itself an S^1 -space (difference of the two actions) and $(X \times X'/S^1)/S^1$ is in fact $(X/S^1) \times (X'/S^1)$. Therefore the Gysin sequence of the S^1 -fibration $X \times X'/S^1 \rightarrow (X/S^1) \times (X'/S^1)$ is

$$\begin{aligned} \dots \rightarrow H_*(X \times X'/S^1) \rightarrow H_*(X/S^1) \otimes H_*(X'/S^1) \\ \rightarrow H_*(X/S^1) \otimes H_*(X'/S^1)[2] \rightarrow HC_{*-1}(X \times X'/S^1) \rightarrow \dots \end{aligned}$$

The proof given here is inspired by this analogy.

The construction of the Künneth sequence for cyclic homology requires the definition of new operators, the *cyclic shuffles*, which will prove useful in handling product structures in cyclic homology. Consequences and applications to

4.3.1 Tensor Product of Cyclic Modules and Mixed Complexes. Let A and A' be two unital k -algebras. The cyclic module $C(A \otimes A')$ is canonically isomorphic to the product of the cyclic modules $C(A)$ and $C(A')$ (cf. 2.5.1.2) since $(A \otimes A')^{\otimes n} \cong (A^{\otimes n}) \otimes (A'^{\otimes n})$. Once this identification is made, the Künneth theorem for cyclic homology is really a result of computing $HC_*(C \times C')$ for two cyclic modules C and C' . The proof of this theorem is divided into two parts as follows.

First, one compares the mixed complex $C \times C' = (C \times C', b, B)$ (cf. 2.5.1.2) with the mixed complex $C \otimes C' = (C \otimes C', b \otimes 1 + 1 \otimes b, B \otimes 1 + 1 \otimes B)$ which is the tensor product of the two mixed complexes (C, b, B) and (C', b, B) . It turns out that their Hochschild and cyclic homologies are isomorphic. The difficulty of the proof is that there is no mixed complex morphism to compare them. Instead there is an S -morphism (cf. 2.5.14). Its explicit construction requires the cyclic shuffles.

Second, the complex $\text{Tot } \mathcal{B}(C \otimes C')$ which computes $HC_*(C \otimes C')$ (and hence $HC_*(C \times C')$) is endowed with a mixed complex structure. The associated Connes exact sequence is the desired Künneth sequence.

4.3.2 Cyclic Shuffles. By definition a (p, q) -cyclic shuffle is a permutation $\{\sigma(1), \dots, \sigma(p + q)\}$ of $\{1, \dots, p + q\}$ obtained as follows. Perform a cyclic permutation of any order on the set $\{1, \dots, p\}$ and a cyclic permutation of any order on the set $\{p + 1, \dots, p + q\}$. Then shuffle the two results to obtain $\{\sigma(1), \dots, \sigma(p + q)\}$. This is a cyclic shuffle if 1 appears before $p + 1$ in this sequence. For instance let $p = 2$ and $q = 1$, then the $(2, 1)$ -cyclic shuffles are $\{1, 2, 3\}$, $\{1, 3, 2\}$ and $\{2, 1, 3\}$. Remark that $\{2, 3, 1\}$, $\{3, 1, 2\}$ and $\{3, 2, 1\}$ are not cyclic shuffles since $3 = p + 1$ appears before 1.

There is defined a map $\perp : C_p(A) \otimes C_q(A') \rightarrow C_{p+q}(A \otimes A')$ given by

$$\begin{aligned} &(a_0, a_1, \dots, a_p) \perp (a'_0, a'_1, \dots, a'_q) \\ &= \sum_{\sigma} \text{sgn}(\sigma) \sigma. (a_0 \otimes a'_0, a_1 \otimes 1, \dots, a_p \otimes 1, 1 \otimes a'_1, \dots, 1 \otimes a'_q) , \end{aligned}$$

where the sum is extended over all (p, q) -cyclic shuffles. More generally if C and C' are simplicial modules there is a similar operation $\perp : C_p \otimes C_q \rightarrow C_n \otimes C'_n, n = p + q$.

Using \perp we define a map of degree 2, called the *cyclic shuffle map*,

$$\begin{aligned} - \times - &= sh'_{pq} : C_p \otimes C'_q \rightarrow C_{p+q+2} \otimes C'_{p+q+2} \\ \text{by } x \times' y &= sh'(x, y) = s(x) \perp s(y) , \end{aligned}$$

where $s : C_n \rightarrow C_{n+1}$ is the extra degeneracy of the cyclic module C (cf. 2.5.7). Recall that when $C = C(A)$ the map s is given by $s(a_0, \dots, a_n) = (1, a_0, \dots, a_n)$, therefore $sh'(x, y)$ is of the form $\Sigma(1 \otimes 1, z_0, \dots, z_{p+q+1})$. An immediate consequence is:

$$(4.3.2.1) \quad \text{for any } x \text{ and } y, \quad Bx \times' y = 0 \quad \text{and} \quad x \times' By = 0.$$

This follows from $Bx \times' y = sBx \perp y$ and $sB = 0$ in the normalized setting.

The following result shows that the obstruction to B being a derivation for the shuffle is equal (up to sign) to the obstruction of b being a derivation for the cyclic shuffle.

4.3.3 Proposition. *For any $x \in C_p(A)$ and any $y \in C_q(A')$ the following equality holds in $C_{p+q+1}(A \otimes A')$:*

$$\begin{aligned} B(x \times y) - \left(B(x) \times y + (-1)^{|x|} x \times B(y) \right) \\ = -b(x \times' y) + b(x) \times' y + (-1)^{|x|} x \times' b(y). \end{aligned}$$

Proof. Remember that we are working in the normalized framework so that C_n is in fact \overline{C}_n in the sequel. We have to prove that the sum (with appropriate signs) of the following six maps is zero:

$$C_p \otimes C'_q \left\{ \begin{array}{l} \xrightarrow{sh'_{pq}} (C \times C')_{p+q+2} \xrightarrow{b} \\ \xrightarrow{b \otimes 1} C_{p-1} \otimes C'_q \xrightarrow{sh'_{p-1q}} \\ \xrightarrow{1 \otimes b} C_p \otimes C'_{q-1} \xrightarrow{sh'_{pq-1}} \\ \xrightarrow{sh_{pq}} (C \times C')_{p+q} \xrightarrow{B} \\ \xrightarrow{B \otimes 1} C_{p+1} \otimes C'_q \xrightarrow{sh_{p+1q}} \\ \xrightarrow{1 \otimes B} C_p \otimes C'_{q+1} \xrightarrow{sh_{pq+1}} \end{array} \right\} (C \times C')_{p+q+1}$$

Let $x = (a_0, \dots, a_p) \in C_p$ and $y = (a'_0, \dots, a'_q) \in C_q$. The image of $x \otimes y$ under any of these composites is the sum of elements of two different types: either it is a permutation of $(a_0 \otimes 1, \dots, a_p \otimes 1, 1 \otimes a'_0, \dots, 1 \otimes a'_q)$, or it is an element of the form $(1 \otimes 1, \dots)$ where one of the other entries is of the form $a_i \otimes a_j$. So the proof can be divided into two parts: the sum of the elements of the first type is 0 (this proof will be carried out in detail), the sum of the elements of the second type is 0 (the proof will be left to the reader).

Elements of the first type arise only from $b \circ sh'_{pq}$ (which also gives elements of the second type), $sh_{p+1q} \circ (B \otimes 1)$ and $sh_{pq+1} \circ (1 \otimes B)$. Let us work with the permutations of $\{1, \dots, p+q\}$. Let $\underline{a} = (a_1, \dots, a_n)$ and τ the cyclic permutation so that $b(1, \underline{a}) = \underline{a} + \text{sgn}(\tau)\tau(\underline{a})$ modulo the elements of the form $(1, -)$. So the permutations coming from $b \circ sh'_{pq}$ are of the form (cyclic

shuffle) or $\tau \circ$ (cyclic shuffle). The cyclic shuffles which have 1 in the first position cancel with the permutations coming from $sh_{p+1q} \circ (B \otimes 1)$. For such a σ , consider $\tau \circ \sigma$. If $p + 1$ is in first position then $\tau \circ \sigma$ cancels with a permutation coming from $sh_{p+1q} \circ (B \otimes 1)$, if not then it is a cyclic shuffle σ' (and it cancels with it). So we are led to examine $\tau \circ \sigma'$ for which we play the same game. By the end all the elements have disappeared. \square

4.3.4 Corollary. *The homomorphism B_* induced by B on Hochschild homology is a derivation for the shuffle product:*

$$B_*(x \times y) = B_*(x) \times y + (-1)^{|x|} x \times B_*(y),$$

for $x \in HH_p(A)$, $y \in HH_q(A)$. \square

4.3.5 Corollary. *In the normalized setting the following formula holds on chains (and therefore on homology),*

$$B(x \times By) = Bx \times By.$$

Proof. It is a consequence of 4.3.3 and of the following properties: $sB = 0$ and $bB = -Bb$ (cf. 2.1.7). \square

4.3.6 Cyclic Shuffle Product. We denote by

$$sh' : (C \otimes C')_n = \bigoplus_{p+q=n} C_p \otimes C_q \rightarrow (C \times C')_{n+2}$$

the sum of all the (p, q) -cyclic shuffle maps sh'_{pq} for $p + q = n$ and call it the *cyclic shuffle product*.

4.3.7 Proposition. *The maps b, B, sh , and sh' satisfy the following formulas in the normalized setting*

$$(4.3.7.1) \quad [b, sh] = 0,$$

$$(4.3.7.2) \quad [B, sh] + [b, sh'] = 0,$$

$$(4.3.7.3) \quad [B, sh'] = 0.$$

Proof. More explicitly the first formula reads $b \circ sh - sh \circ (b \otimes 1 + 1 \otimes b) = 0$ and similarly for the two other formulas.

Formula (4.3.7.1) is an immediate consequence of 4.2.4 and (4.3.7.2) is an immediate consequence of 4.3.3.

Formula (4.3.2.1) implies that all the terms in (4.3.7.3) are 0, whence the equality. \square

4.3.8 Theorem (Eilenberg-Zilber Theorem for Cyclic Homology). *Let C and C' be two cyclic modules and let $C \otimes C'$ be the tensor product of their associated mixed complexes. Then there is a canonical isomorphism*

$$Sh : HC_*(C \otimes C') \cong HC_*(C \times C')$$

induced by the shuffle product and the cyclic shuffle product. It commutes with the morphisms B , I and S of Connes' exact sequence.

Proof. The shuffle map $sh : C \otimes C' \rightarrow C \times C'$ is a map of b -complexes by (4.3.7.1); however it is not a map of mixed complexes since B does not commute with sh .

By the classical Eilenberg-Zilber theorem (cf. 4.2.5) sh is a quasi-isomorphism on Hochschild homology. So, to prove the announced isomorphism, it is sufficient to provide a degree 0 map $Sh : \text{Tot } \mathcal{B}(C \otimes C') \rightarrow \text{Tot } \mathcal{B}(C \times C')$ such that the following diagram commutes

$$\begin{array}{ccccccc} 0 \rightarrow & C \otimes C' & \rightarrow & \text{Tot } \mathcal{B}(C \otimes C') & \rightarrow & \text{Tot } \mathcal{B}(C \otimes C')[2] & \rightarrow 0 \\ & \downarrow sh & & \downarrow sh & & \downarrow Sh[2] & \\ 0 \rightarrow & C \times C' & \rightarrow & \text{Tot } \mathcal{B}(C \times C') & \rightarrow & \text{Tot } \mathcal{B}(C \times C')[2] & \rightarrow 0 \end{array}$$

Recollect that $(\text{Tot } \mathcal{B}(C \otimes C'))_n = (C \otimes C')_n \oplus (C \otimes C')_{n-2} \oplus \dots$, and similarly for $\text{Tot } \mathcal{B}(C \times C')$. So Sh can be viewed as a matrix (S -morphism in the sense of 2.5.14). Our choice for Sh is

$$Sh = \begin{bmatrix} sh & sh' & 0 & & \\ & sh & sh' & 0 & \\ & & sh & sh' & \cdot \\ & & & \cdot & \cdot & \cdot \end{bmatrix}$$

where sh and sh' are as defined in 4.2.8 and 4.3.6 respectively. By Proposition 4.3.7 Sh is a morphism of complexes. The commutativity of the right-hand square comes from the form of the matrix Sh (same elements on the diagonals). The commutativity of the left hand square is immediate. This finishes the proof of the theorem. \square

Now we compare $HC(C \otimes C')$ with $HC(C) \otimes HC(C')$.

4.3.9 Lemma. *For any mixed complexes C and C' there is a short exact sequence of chain complexes*

$$0 \rightarrow \text{Tot } \mathcal{B}(C \otimes C') \xrightarrow{\Delta} \text{Tot } \mathcal{B}(C) \otimes \text{Tot } \mathcal{B}(C') \xrightarrow{S \otimes 1 - 1 \otimes S} (\text{Tot } \mathcal{B}(C) \otimes \text{Tot } \mathcal{B}(C'))[2] \rightarrow 0 .$$

Proof. It is immediate that $S \otimes 1 - 1 \otimes S$ is surjective. To compute the kernel let us identify $\text{Tot } \mathcal{B}(C)$ with $k[u] \otimes C$ where $|u| = 2$ (resp. $\text{Tot } \mathcal{B}(C')$ with

$k[u'] \otimes C'$ where $|u'| = 2$, resp. $\text{Tot } \mathcal{B}(C \otimes C')$ with $k[v] \otimes C \otimes C'$ where $|v| = 2$). Since $S : k[u] \otimes C \rightarrow k[u] \otimes C$ is given by $S(u^n \otimes x) = u^{n-1} \otimes x$ one sees that the kernel of $S \otimes 1 - 1 \otimes S$ is made of the elements generated by

$$\sum_{p+q=n} u^p u'^q x x'.$$

Hence $\Delta : k[v] \otimes (C \otimes C') \rightarrow k[u] \otimes C \otimes k[u'] \otimes C' \cong k[u, u'] \otimes (C \otimes C')$ is induced by

$$v^n \mapsto \sum_{p+q=n} u^p u'^q.$$

It is straightforward to check that the boundary of $\text{Tot } \mathcal{B}(C) \otimes \text{Tot } \mathcal{B}(C')$ restricted to the image of Δ coincides with the boundary of $\text{Tot } \mathcal{B}(C \otimes C')$. \square

4.3.10 Proposition. *Suppose that the k -modules C'_* and $HC_*(C')$ are projective (e.g. k is a field). Then there is a long exact sequence*

$$\begin{aligned} \dots \rightarrow HC_n(C \otimes C') \xrightarrow{i} \bigoplus_{r+s=n} HC_r(C) \otimes HC_s(C') \xrightarrow{S \otimes 1 - 1 \otimes S} \\ \bigoplus_{p+q=n-2} HC_p(C) \otimes HC_q(C') \xrightarrow{\partial} HC_{n-1}(C \otimes C') \rightarrow \dots \end{aligned}$$

Proof. The hypothesis about projectiveness implies that the homology of $\text{Tot } \mathcal{B}(C) \otimes \text{Tot } \mathcal{B}(C')$ is precisely $HC_*(C) \otimes HC_*(C')$ by the Künneth theorem (cf. 1.0.16). Hence the exact sequence is the homology exact sequence of Lemma 4.3.9. \square

Finally we can state our main theorem comparing $HC_n(A \otimes A')$ with $HC_n(A)$ and $HC_n(A')$.

4.3.11 Theorem (Künneth Exact Sequence of Cyclic Homology). *Let C and C' be two cyclic modules. Suppose that C' and $H_*(C')$ are projective over the ground ring k . Then there is a canonical exact sequence*

$$\begin{aligned} \dots \rightarrow HC_n(C \times C') \xrightarrow{i} \bigoplus_{r+s=n} HC_r(C) \otimes HC_s(C') \xrightarrow{S \otimes 1 - 1 \otimes S} \\ \bigoplus_{p+q=n-2} HC_p(C) \otimes HC_q(C') \xrightarrow{\partial} HC_{n-1}(C \times C') \rightarrow \dots \end{aligned}$$

Proof. This is an immediate consequence of Theorem 4.3.8 and Proposition 4.3.10. \square

4.3.12 Corollary. *Let A and A' be two unital k -algebras such that A' and $HH_*(A')$ are projective over k . Then there is a canonical exact sequence*

$$\begin{aligned} \dots \rightarrow HC_n(A \otimes A') &\xrightarrow{\Delta} \bigoplus_{r+s=n} HC_r(A) \otimes HC_s(A') \xrightarrow{S \otimes 1 - 1 \otimes S} \\ &\bigoplus_{p+q=n-2} HC_p(A) \otimes HC_q(A') \xrightarrow{\partial} HC_{n-1}(A \otimes A') \rightarrow \dots \quad \square \end{aligned}$$

Exercises

E.4.3.1. Find a conceptual proof of Proposition 4.3.3. [See the last sentence of the proof of Proposition 4.2.2.]

E.4.3.2. Show that the complex $\text{Tot } \mathcal{B}(C \otimes C')$ is equipped with a degree +1 map which makes it into a mixed complex quasi-isomorphic to the tensor product of the mixed complexes $\text{Tot } \mathcal{B}(C)$ and $\text{Tot } \mathcal{B}(C')$. (This fits with the philosophy described in the introduction of this section.)

E.4.3.3. Let k be a field and A, A' be unital k -algebras. Show that there is an exact sequence

$$\begin{aligned} 0 \rightarrow (HC_*(A) \otimes_{k[u]} HC_*(A'))_{n-1} &\rightarrow HC_n(A \otimes A') \\ &\rightarrow (\text{Tor}_{k[u]}(HC_*(A), HC_*(A'))_{n-2} \rightarrow 0. \end{aligned}$$

(This is another way of interpreting Corollary 4.3.12, cf. Hood-Jones [1987, Theorem 3.2].)

E.4.3.4. Show that the Künneth exact sequence is valid for non-unital algebras.

4.4 Product, Coproduct in Cyclic Homology

In this section we show that cyclic homology is endowed with a product

$$HC_p(A) \times HC_q(A') \rightarrow HC_{p+q+1}(A \otimes A').$$

It may seem strange to have $p + q + 1$ instead of $p + q$. In fact we will see later that cyclic homology is an additive analogue of algebraic K -theory and so is sometimes called ‘additive K -theory’ and denoted $HC_n = K_{n+1}^+$. The shift of degree in this notation is due to the fact that K_n^+ (and so HC_{n-1}) is related to H_n of Lie algebras of matrices, like K_n is related to H_n of the general linear group. We want to show that, as in algebraic K -theory, there is a product $K_p^+ \times K_q^+ \rightarrow K_{p+q}^+$, which, in our standard notation, gives

$$HC_{p-1} \times HC_{q-1} \rightarrow HC_{p+q-1}.$$

We also show that cyclic homology is equipped with a coproduct

$$HC_n(A \otimes A') \rightarrow \bigoplus_{n=p+q} HC_p(A) \otimes HC_q(A').$$

Translated into cohomology the product becomes a coproduct and vice versa. Then the periodicity map S can be interpreted as the product by the canonical generator of $HC^2(k)$.

4.4.1 Product Structure in Cyclic Homology. Let A and A' be two unital k -algebras. Recall that $\text{Tot } \mathcal{B}(C)_p = C_p \oplus C_{p-2} \oplus \dots$ where $C_p = C_p(A)$. Define a product on chains

$$* : \text{Tot } \mathcal{B}(C)_p \otimes \text{Tot } \mathcal{B}(C')_q \rightarrow \text{Tot } \mathcal{B}(C \times C')_{p+q+1}$$

by the formula

$$x * y = (Bx_p \times y_q, Bx_p \times y_{q-2}, \dots),$$

for $x = (x_p, x_{p-2}, \dots)$ and $y = (y_q, y_{q-2}, \dots)$.

Let us show that this is a map of chain complexes. It amounts to proving that

$$\begin{aligned} b(Bx_p \times y_q) + B(Bx_p \times y_{q-2}) \\ = B(bx_p + Bx_{p-2}) \times y_q + (-1)^p Bx_p \times (by_q + By_{q-2}) \end{aligned}$$

and similarly for the other entries. This formula is an immediate consequence of the fact that b is a derivation for \times (cf. 4.2.2) and that B is almost a derivation for \times (cf. 4.3.5). So we have proved the first part of the following

4.4.2 Theorem. *The map $*$ induces a product*

$$* : HC_p(A) \times HC_q(A') \rightarrow HC_{p+q+1}(A \otimes A')$$

in cyclic homology. It is associative and graded commutative provided that, for all n , HC_n is considered having degree $n + 1$:

$$x * y = (-1)^{(p+1)(q+1)} T_*(y * x), \quad \text{for } x \in HC_p(A) \text{ and } y \in HC_q(A'),$$

where $T : A \otimes A' \cong A' \otimes A$ is the twisting map.

Proof. We just proved that this map is well-defined. Associativity follows from Corollary 4.3.5. To prove graded commutativity it suffices to compute (by using the formulas of 4.3.7) the boundary of

$$z = (x_p \times' y_q, x_p \times y_q + x_p \times' y_{q-2} + x_{p-2} \times' y_q, \dots).$$

Indeed

$$\begin{aligned} (b + B)(z) &= (b(x_p \times' y_q) + B(x_p \times y_q), \dots) \\ &= (b(x_p) \times' y_q + (-1)^p x_p \times' b(y_q) + B(x_p) \times y_q + (-1)^p x_p \times B(y_q), \dots). \end{aligned}$$

Suppose that x and y are cycles. Then $bx_p + Bx_{p-2} = 0$, etc. So $b(x_p) \times' y_q = -B(x_{p-2}) \times' y_q = 0$ by (4.3.2.1), etc. Finally $(b + B)(z) = (B(x_p) \times y_q + (-1)^p x_p \times B(y_q), \dots)$. Since $T_*(B(y_q) \times x_p) = (-1)^{q(p+1)} x_p \times B(y_q)$ we have proved that $\partial(z) = (B(x_p) \times y_q, \dots) - (-1)^{(p+1)(q+1)} T_*(B(y_q) \times x_p, \dots) = x * y - (-1)^{(p+1)(q+1)} T_*(y * x)$ is a boundary. Passing to homology gives the desired result. \square

4.4.3 Proposition. *The boundary map ∂ in the exact sequence of Corollary 4.3.12 is the product $*$ in cyclic homology,*

$$\partial(x \otimes y) = x * y .$$

Proof. This formula is a consequence of the following diagram chasing in the exact sequence of Lemma 4.3.9. Let x and y be cycles. Their tensor product is the image by $S \otimes 1 - 1 \otimes S$ of

$$(0, x_p, x_{p-2}, \dots) \otimes (y_q, y_{q-2}, \dots) + (0, 0, x_p, x_{p-2}, \dots) \otimes (y_{q-2}, y_{q-4}, \dots) + \dots .$$

The boundary in $\text{Tot } \mathcal{B}(C) \otimes \text{Tot } \mathcal{B}(C')$ of this lifting is

$$(Bx_p, 0, \dots) \otimes (y_q, y_{q-2}, \dots) + (0, Bx_p, 0, \dots) \otimes (y_{q-2}, y_{q-4}, \dots) + \dots ,$$

which is the image of the cycle

$$(Bx_p, y_q) + (Bx_p, y_{q-2}) + \dots \in (\text{Tot } \mathcal{B}(C \otimes C'))_{p+q+1} .$$

The image of this cycle under Sh is

$$(Bx_p \times y_q + Bx_p \times' y_{q-2}, Bx_p \times y_{q-2} + Bx_p \times' y_{q-4}, \dots) .$$

By (4.3.2.1) we can get rid of all the terms containing \times' . Hence we have proved that

$$\partial(x \otimes y) = (Bx_p \times y_q, Bx_p \times y_{q-2}, \dots) = x * y . \quad \square$$

4.4.4 Internal Product on Cyclic Homology. If $A' = A$ and A is commutative, then we can compose with the map induced by the algebra map $\mu : A \otimes A \rightarrow A, a \otimes b \mapsto ab$, to get an internal product on cyclic homology:

$$* : HC_p(A) \otimes HC_q(A) \rightarrow HC_{p+q+1}(A) .$$

Obviously it makes $HC_*(A)[1]$ into a graded algebra over k . For $p = q = 0$ this product $A \otimes A \rightarrow \Omega_{A|k}^1/dA$ is given by $a * b = (a db)$. Graded commutativity can be checked directly: $a * b + b * a = adb + bda = d(ab) = 0 \pmod{dA}$.

This internal product behaves as follows with respect to Connes' exact sequence:

- Connes' map $B : HC_{*-1}(A) \rightarrow HH_*(A)$ is a graded algebra map. This follows immediately from the explicit construction of $*$ (cf. 4.4.2) and from Corollary 4.3.5.
- via B and the shuffle product, HH_* becomes an HC_* -module. The map I is an HC_* -module map. In other words there is a 'projection formula':

$$(4.4.4.1) \quad I(B(x) \times y) = x * I(y) \quad \text{and also} \quad I(x \times B(y)) = I(x) * y$$

(this follows immediately from the definition of $*$),

- finally, $S(x * y) = x * S(y)$. An interesting consequence of this formula is

$$x * S(y) = (-1)^{(p+1)(q+1)} S(x) * y .$$

In other words the map $*$ factors through $HC_*(A) \otimes_{HC_*(k)} HC_*(A)$.

The comparison with the exterior product of differential forms is as follows. First one remarks that $I \circ \varepsilon_n : \Omega^n/d\Omega^{n-1} \rightarrow HC_n$ (cf. 2.3.5) sends the class of $a_0 da_1 \dots da_n$ to the iterated product $a_0 * \dots * a_n$. Indeed the commutativity of the diagram 2.3.3 and formula (4.4.4.1) imply that $I \circ \varepsilon_n(a_0 da_1 \dots da_n) = I(a_0 \times B(a_1) \times \dots \times B(a_n)) = a_0 * \dots * a_n$. As a consequence one has

$$(4.4.4.2)$$

$$\varepsilon_{p+q+1}(\omega \wedge d\omega') = \varepsilon_p(\omega) * \varepsilon_q(\omega') , \text{ for } \omega \in \Omega^p/d\Omega^{p-1} \text{ and } \omega' \in \Omega^q/d\Omega^{q-1} .$$

When the algebra is smooth we showed in 3.4.12 that there is a splitting $HC_n = \Omega^n/d\Omega^{n-1} \oplus H_{DR}^{n-2} \oplus \dots$. Let us write $x = (\bar{x}, \dots)$ accordingly; then

$$(4.4.4.3) \quad x * y = (\bar{x} \wedge d\bar{y}, 0, 0, \dots) .$$

4.4.5 Product in Connes' Setting. From the definition of the product in HC it is immediate that

$$* : HC_p^\lambda \times HC_q^\lambda \rightarrow HC_{p+q+1}^\lambda$$

is simply given by $x * y = Bx \times y$. The interesting point in this framework is that graded commutativity is *strict* on chains (\bar{C}_*^λ) . Indeed the first component of z in the Proof of 4.4.2 is $x_p \times' y_q$, which is trivial in $\bar{C}_{p+q+2}^\lambda(A \otimes A')$ since it is of the form $(1 \otimes 1, \dots)$ (cf. 4.3.2). Therefore one has $x * y - (-1)^{(p+1)(q+1)} T_*(y * x) = \partial(z) = 0$ in \bar{C}_{p+q+1}^λ .

As a consequence (\bar{C}_*^λ, b) is a solution of Sullivan's commutative cochain problem for the reduced Deligne complex of an affine smooth algebra over \mathbb{Q} (or any characteristic zero field).

4.4.6 Coproduct Structure on HC . The map

$$\Delta : HC_n(A \otimes A') \rightarrow \bigoplus_{r+s=n} HC_r(A) \otimes HC_s(A')$$

appearing in the exact sequence of Corollary 4.3.12 defines a coproduct map, which is co-associative.

Let u denote the canonical generator of $HC_2(k)$. Then $HC_*(k)$ becomes a graded coalgebra isomorphic to $k[u] = k \oplus ku \oplus ku^2 \oplus \dots$ with coproduct structure given by

$$\Delta(u^n) = \sum_{p+q=n} u^p \otimes u^q .$$

This follows from the description of the inclusion map of complexes Δ given in the proof of Lemma 4.3.9.

The graded module $HC_*(A)$ becomes a $k[u]$ -comodule:

$$HC_*(A) \rightarrow HC_*(A) \otimes k[u] , \quad x \mapsto \sum_{i \geq 0} S^i x \otimes u^i$$

where S^i is the periodicity map S iterated i times.

When A is commutative this coproduct endows A with a structure of graded commutative coalgebra structure (cf. Appendix A).

4.4.7 Trivial and Free Comodule Structures on $HC_*(A)$. The $k[u]$ -comodule structure of the graded module M_* is completely determined by the graded k -linear map $S : M_* \rightarrow M_{*-2}$. As mentioned in 2.5.17 there are two extreme cases of comodule structures:

- (a) *free comodule structure*: let U_* be a graded k -module and define S on $k[u] \otimes U_*$ (recall that u is of degree 2) by $S(u^n \otimes x) = u^{n-1} \otimes x$ if $n \geq 1$ and $S(1 \otimes x) = 0$.
- (b) *trivial comodule structure*: V_* is a graded k -module and $S = 0$,

Topologically these two cases correspond respectively to an S^1 -space X such that

- (a) the action of S^1 is trivial, hence $ES^1 \times_{S^1} X = BS^1 \times X$. So the homology group $H_*(ES^1 \times_{S^1} X) = H_*(BS^1 \times X) = k[u] \otimes H_*(X)$ is a free $k[u]$ -comodule.
- (b) X is of the form $S^1 \times Y$ with S^1 acting trivially on Y , then $ES^1 \times_{S^1} X = ES^1 \times Y \sim Y$. So the homology group $H_*(ES^1 \times_{S^1} X) = H_*(Y)$ is a trivial $H_*(BS^1) = k[u]$ -comodule.

4.4.8 Proposition. *Let A and A' be two unital k -algebras. Suppose that A' is flat over k and that $HC_*(A') = k[u] \otimes U_* \oplus V_*$ where U_* and V_* are (graded) trivial $k[u]$ -comodules which are flat over k . Then*

$$HC_*(A \otimes A') = HC_*(A) \otimes U_* \oplus HH_*(A) \otimes V_* .$$

Proof. It suffices to treat the cases $HC_*(A') = k[u] \otimes U_*$ and $HC_*(A') = V_*$ separately. Since the $k[u]$ -comodule structure is induced by S , each of these cases is a consequence of Corollary 4.3.12. □

4.4.9 Application to Computations. For $A' = k[x]$ one has $HC_*(k[x]) = k[u] \otimes (k \oplus T) \oplus xk[x]$, where in $k \oplus T$ the component k is in dimension 0 and $T = \bigoplus_{m \geq 2} \mathbb{Z}/m\mathbb{Z}$ is in dimension 1, and where $xk[x]$ is concentrated in degree 0 (cf. 3.1.6). It follows that

$$(4.4.9.1) \quad HC_n(A[x]) = HC_n(A) \oplus HC_{n-1}(A) \otimes T \oplus HH_n(A) \otimes xk[x].$$

In particular if k contains \mathbb{Q} one has

$$(4.4.9.1)_{\mathbb{Q}} \quad HC_n(A[x]) = HC_n(A) \oplus HH_n(A) \otimes xk[x].$$

Similarly if A' is the Laurent polynomial algebra $k[x, x^{-1}]$ (which is smooth), then rationally $HC_*(k[x, x^{-1}]) = k[u] \otimes (k \cdot 1 \oplus k \cdot dx) \oplus (1-x)k[x, x^{-1}]$. It follows that if k contains \mathbb{Q} then

$$(4.4.9.2)_{\mathbb{Q}} \quad HC_n(A[x, x^{-1}]) = HC_n(A) \oplus HC_{n-1}(A) \oplus HH_n(A) \otimes (1-x)k[x, x^{-1}].$$

In fact this last case is a particular example of a smooth algebra A' . So if k contains \mathbb{Q} one can rewrite Theorem 3.4.12 as

$$HC_*(A') = k[u] \otimes H_{DR}^*(A') \oplus \Omega_{A'|k}^*/\text{Ker } d$$

since S is trivial on this last component. Consequently one has

$$(4.4.9.3)_{\mathbb{Q}} \quad HC_*(A \otimes A') = HC_*(A) \otimes H_{DR}^*(A') \oplus HH_*(A) \otimes \Omega_{A'|k}^*/\text{Ker } d.$$

4.4.10 Product and Coproduct in Cyclic Cohomology. All previous results can be translated in the cohomological framework. The coproduct becomes a product (called the *cup-product*)

$$\cup : HC^p(A) \otimes HC^q(A') \rightarrow HC^{p+q}(A \otimes A')$$

and the product becomes a coproduct

$$\nabla : HC^n(A \otimes A') \rightarrow \bigoplus_{r+s=n-1} HC^r(A) \otimes HC^s(A').$$

(Note the shift of degree.) They fit into a long exact sequence

$$\begin{aligned} \dots \rightarrow HC^n(A \otimes A') \xrightarrow{\nabla} \bigoplus_{r+s=n-1} HC^r(A) \otimes HC^s(A') \xrightarrow{S \otimes 1 - 1 \otimes S} \\ \bigoplus_{p+q=n+1} HC^p(A) \otimes HC^q(A') \xrightarrow{\cup} HC^{n+1}(A \otimes A') \rightarrow \dots \end{aligned}$$

When A is commutative $HC^*(A)$ inherits a structure of graded commutative algebra. For $A = k$, $HC^*(k)$ is isomorphic to the *polynomial* algebra $k[u]$,

with $|v| = 2$. Then $HC^*(A)$ is a $HC^*(k) = k[v]$ -module and the action of v is simply the periodicity map S :

$$(4.4.10.1) \quad S(x) = v \cup x \quad \text{for any } x \in HC_n(A).$$

Exercises

E.4.4.1 Show graded commutativity for the product $*$ on cyclic homology by using the proof of Proposition 4.4.3 (i.e. $\partial(x \otimes y) = x * y$). [Find another lifting of $x \otimes y$.]

E.4.4.2 Let CA and SA be the cone and the suspension of the k -algebra A as defined in Exercise E 1.4.4. Show that $HC_*(CA) = 0$ and $HC_*(SA) = HC_{*-1}(A)$. (Prove the case $A = k$ first. Compare with K -theory, cf. Loday [1976].)

E.4.4.3. Let A' be a separable flat algebra over k . Show that

$$HC_*(A \otimes A') = HC_*(A) \otimes A' / [A', A'] .$$

(Cf. for instance Kassel [1987, p. 210].)

4.5 λ -Decomposition for Hochschild Homology

If the ground ring k contains \mathbb{Q} and if the k -algebra A is commutative, then the Hochschild homology groups split functorially into smaller pieces when $n \geq 1$:

$$HH_n(A) = HH_n^{(1)}(A) \oplus \dots \oplus HH_n^{(n)}(A) .$$

This is called the λ -decomposition of Hochschild homology. The part $HH_n^{(1)}$ can be identified with Harrison-André-Quillen homology and the part $HH_n^{(n)}$ is simply Ω^n . Such a decomposition was already obtained in 3.5.8, but here we look at this theorem from a completely different point of view, we analyze the action of the symmetric group S_n on $M \otimes A^{\otimes n}$.

In the first part we describe some families of elements $Id^{*k}, e^{(k)}$ in the general setting of Hopf algebras. Applied to the particular case of the cotensor algebra they give elements of $\mathbb{Q}[S_n]$, denoted $\bar{\lambda}_n^k$ and $e_n^{(k)}$ (Eulerian idempotents). Each family spans the same commutative sub-algebra of $\mathbb{Q}[S_n]$. These elements are related to the Eulerian numbers and to several interesting combinatorial identities. For instance the family $e_n^{(1)}, n \geq 0$, plays a striking role in the Campbell-Hausdorff formula (cf. Exercise E.4.5.5).

For us the main property of interest of the Eulerian idempotents is their commutation with the Hochschild boundary:

$$be_n^{(i)} = e_{n-1}^{(i)} b .$$

The splitting of Hochschild homology mentioned above follows from this property. The same idempotents will enable us to give a similar decomposition for cyclic homology in the next section. If the hypothesis k contains \mathbb{Q} is not fulfilled, then the λ -decomposition has to be replaced by a filtration, which exists because $\overline{\lambda}_n^k \in \mathbb{Z}[S_n]$.

Though the hypothesis ‘ A commutative’ is crucial for the existence of the decomposition, something remains for a general algebra A (cf. 4.5.17).

The relationship between the simplicial structure of $A^{\otimes n}$ and the action of S_n will be axiomatized in Sect. 6.4. It brings to light the category of finite sets.

The results of this section are essentially taken out of Gerstenhaber and Schack [1987] and Loday [1989].

4.5.1 Convolution in a Commutative Hopf Algebra.

Let $\mathcal{H} = (\mathcal{H}, \mu, \Delta, u, c)$ be a commutative Hopf algebra over k (cf. Appendix A). By definition the *convolution* of two k -linear maps f and g from \mathcal{H} to itself is

$$f * g = \mu \circ (f \otimes g) \circ \Delta .$$

(So now $*$ has a different meaning as in the previous section).

It is easy to check that, if f is an algebra morphism, then for any k -linear maps g and h one has

$$(4.5.1.1) \quad f \circ (g * h) = (f \circ g) * (f \circ h) .$$

It is also immediate to check that, if \mathcal{H} is commutative and if f and g are algebra morphisms, then

$$(4.5.1.2) \quad f * g \text{ is an algebra morphism .}$$

From (4.5.1.2) one deduces that $Id^{*k} := Id * \dots * Id$ (k times) is an algebra morphism and by (4.5.1.1) that

$$(4.5.1.3) \quad Id^{*k} \circ Id^{*k'} = Id^{*(kk')} .$$

These constructions and properties are easily generalized to graded commutative Hopf algebras.

4.5.2 Eulerian Idempotents in a CGH-Algebra. It is immediate to check that the convolution is an associative operation whose neutral element is the map uc . Hence $(\text{End}_k \mathcal{H}, +, *)$ becomes a k -algebra. Suppose now that \mathcal{H} is graded with $\mathcal{H}_0 = k$ and consider only the k -linear maps of degree 0 (the convolution of maps of degree 0 is still of degree 0). Suppose moreover that $f : \mathcal{H} \rightarrow \mathcal{H}$ is such that $f(1) = 0$ (where $1 \in k = H_0$). Then, by induction, the map $f^{*k} = f * \dots * f$ (k times) is 0 when restricted to \mathcal{H}_n for $n < k$. Consequently the series

$$(4.5.2.1) \quad e^{(1)}(f) := \log(uc + f) = f - \frac{f^{*2}}{2} + \dots + (-1)^{i+1} \frac{f^{*i}}{i} + \dots$$

has a meaning, since restricted to \mathcal{H}_n it is a polynomial. Similarly the product

$$(4.5.2.2) \quad e^{(i)}(f) := \frac{(e^{(1)}(f))^{*i}}{i!}$$

is well-defined and determines a k -linear endomorphism of \mathcal{H}_n denoted by $e_n^{(i)}(f)$. It is clear that $e_0^{(1)}(f) = 0$ and, by the same argument as above, we get

$$(4.5.2.3) \quad e_n^{(i)}(f) = 0 \quad \text{for } i > n.$$

The formal series $\exp(X) = 1 + \sum_{i \geq 1} X^i/i!$ and $\log(1+X) = \sum_{i \geq 1} (-1)^{i+1} X^i/i$ are related by the identity $(1+X)^k = \exp(k \log(1+X))$. Applying this identity to the element f of the ring $(\text{End}_k \mathcal{H}, +, *)$ yields the formula

$$(4.5.2.4)_k \quad (uc + f)^{*k} = uc + \sum_{i \geq 1} k^i e^{(i)}(f).$$

The meaning of the left-hand side is clear. For the right-hand side we remark that $\log(uc + f) = e^{(1)}(f)$ by definition. Therefore

$$\exp\left(ke^{(1)}(f)\right) = uc + \sum_{i \geq 1} \frac{(ke^{(1)}(f))^{*i}}{i!} = uc + \sum_{i \geq 1} k^i e^{(i)}(f).$$

Our main interest is to apply this formula to $f = Id - uc$ (which readily satisfies $f(1) = 0$) and we put

$$(4.5.2.5) \quad e^{(i)} := e^{(i)}(Id - uc), \quad e_n^{(i)} := e_n^{(i)}(Id - uc), \quad i \geq 1, n \geq 1.$$

(Note that extending formula (4.5.2.2) to $i = 0$ gives $e^{(0)} = uc$, so $e_0^{(0)} = 1$ and $e_n^{(0)} = 0$ otherwise). Making (4.5.2.4)_k explicit in this particular case gives

$$(4.5.2.6)_k \quad (Id^{*k})|_{\mathcal{H}_n} = \sum_{i=1}^n k^i e_n^{(i)}, \quad n \geq 1.$$

4.5.3 Proposition. *For any CGH-algebra \mathcal{H} the elements $e_n^{(i)} \in \text{End}_k(\mathcal{H}_n)$ verify for $n \geq 1$:*

- (a) $Id = e_n^{(1)} + \dots + e_n^{(n)},$
- (b) $e_n^{(i)} e_n^{(j)} = 0$ if $i \neq j$ and $e_n^{(i)} e_n^{(i)} = e_n^{(i)}.$

Proof. Formula a) is simply (4.5.2.6)₁.

Fix $n \geq 1$ and consider the n equations $(4.5.2.6)_k$, $k = 1, \dots, n$. Since the Vandermonde matrix (with (k, i) -entry equal to (k^i)) is invertible in \mathbb{Q} , the elements $e_n^{(i)}$, $i = 1, \dots, n$ are completely determined by the restrictions $(Id^{*k})|_{\mathcal{H}_n}$. Therefore formulas (4.5.1.3) imply that there is a unique formula of the form $e_n^{(i)} e_n^{(j)} = \sum_{m=1}^n a_{ijm} e_n^{(m)}$. Applying again formulas (4.5.1.3), we get

$$\sum_{\substack{1 \leq i \leq n \\ 1 \leq j \leq n}} k^i k'^j a_{ijm} = (kk')^m, \quad m = 1, \dots, n,$$

for any positive integers k and k' . The only solution is given by b). □

4.5.4 λ -Operations and Eulerian Idempotents in $\mathbb{Q}[S_n]$. Let A be a $k = \mathbb{Q}$ -module (we do not use the algebra structure of A for the time being) and let $\mathcal{H} = T'(A)$ be the graded cotensor Hopf algebra (cf. Appendix A). Explicitly $\mathcal{H}_0 = k$, $\mathcal{H}_1 = A$, and more generally $\mathcal{H}_n = A^{\otimes n}$. The comultiplication is given by “deconcatenation” (also called cut-product),

$$\Delta(a_1, \dots, a_n) = \sum_{i=0}^n (a_1, \dots, a_i) \otimes (a_{i+1}, \dots, a_n).$$

The multiplication is given by the “signed shuffle”:

$$(4.5.4.1) \quad \begin{aligned} \mu((a_1, \dots, a_n) \otimes (a_{p+1}, \dots, a_{p+q})) \\ = \sum_{\sigma=(p,q)\text{-shuffle}} \text{sgn}(\sigma) \sigma.(a_1, \dots, a_{p+q}). \end{aligned}$$

This is a commutative graded Hopf algebra to which one can apply the constructions of 4.5.1. and 4.5.2. We denote by $\bar{\lambda}^k : T'(A) \rightarrow T'(A)$ the operator Id^{*k} in this setting. Obviously it is a degree zero operator and its restriction to $A^{\otimes n}$, which takes values in $A^{\otimes n}$, is denoted $\bar{\lambda}_n^k$ and called a λ -operation. By homogeneity the image of a generic element $(a_1, \dots, a_n) \in A^{\otimes n} = \mathcal{H}_n$ is of the form $\sum_{\sigma \in S_n} a(\sigma) \sigma.(a_1, \dots, a_n)$ with $a(\sigma) \in \mathbb{Z}$ uniquely determined. The element $\sum_{\sigma \in S_n} a(\sigma) \sigma \in \mathbb{Z}[S_n]$ is still denoted by $\bar{\lambda}_n^k$ (note that $\bar{\lambda}_n^1 = 1$, the neutral element of $\mathbb{Z}[S_n]$). We will sometimes use $\lambda_n^k := (-1)^{k-1} \bar{\lambda}_n^k$ (the true λ -operations) and also $\psi_n^k = k \bar{\lambda}_n^k$ (Adams operations). See 4.5.16 for more comments. Since the composition of endomorphisms of \mathcal{H}_n corresponds to the product in the group algebra $\mathbb{Z}[S_n]$, formula (4.5.1.3) becomes

$$(4.5.4.2) \quad \bar{\lambda}_n^k \bar{\lambda}_n^{k'} = \bar{\lambda}_n^{kk'} \in \mathbb{Z}[S_n].$$

Similarly there are defined elements

$$e_n^{(i)} \in \mathbb{Q}[S_n], \quad n \geq 1,$$

called the *Eulerian idempotents*, which satisfy the formulas of Proposition 4.5.3. Therefore they are indeed idempotents, in fact orthogonal idempotents. An explicit description is given below. Then formula (4.5.2.6)_k becomes the following formula in $\mathbb{Q}[S_n]$:

$$(4.5.4.3)_k \quad \bar{\lambda}_n^k = k e_n^{(1)} + \dots + k^n e_n^{(n)}, \quad n \geq 1.$$

4.5.5 The Eulerian Decomposition of the Symmetric Group. Let $\sigma \in S_n$ be a permutation acting on the set $\{1, 2, \dots, n\}$. If $\sigma(i) > \sigma(i + 1)$, then σ is said to have a *descent* at i ($1 \leq i < n$). For instance the permutation

$$\sigma = \begin{pmatrix} 1 & 2 & 3 & 4 \\ 3 & 1 & 4 & 2 \end{pmatrix}$$

has 2 descents, at 1 and at 3.

Let $S_{n,k} := \{\sigma \in S_n \mid \sigma \text{ has } (k - 1) \text{ descents}\}$. The partition $S_n = S_{n,1} \cup \dots \cup S_{n,n}$ is called the *Eulerian partition* of S_n . Remark that $S_{n,1} = \{id_n\}$ and $S_{n,n} = \{\omega_n\}$, where $\omega_n = (1\ n)(2\ n - 1) \dots$ as a product of cycles. More generally one checks easily that $S_{n,k}\omega_n = S_{n,n-k+1}$.

The number $\alpha_{n,k}$ of elements of $S_{n,k}$ is classically called an *Eulerian number* whence the name of the partition. Eulerian numbers are different from the classical Euler numbers.

By definition the *Eulerian element* l_n^k is defined for $1 \leq k \leq n$ by the formula

$$l_n^k := \sum_{\sigma \in S_{n,k}} \text{sgn}(\sigma)\sigma \in \mathbb{Z}[S_n].$$

(This definition differs from Loday [1989] by the sign $(-1)^{k-1}$). In fact we extend the definition of l_n^k to all integer values of n and k by putting $l_0^0 = 1 \in \mathbb{Z}[S_0] = \mathbb{Z}$, and $l_n^k = 0$ in all other cases. Remark that $l_n^1 = id$ and $l_n^n = (-1)^{n(n-1)/2}\omega_n$.

4.5.6 Proposition. *The relationship between the λ -operations, the Eulerian idempotents and the Eulerian elements is given by the following formulas:*

$$\bar{\lambda}_n^k = \sum_{i=0}^k \binom{n+i}{n} l_n^{k-i}, \quad l_n^{k-i} = \sum_{i=0}^k (-1)^i \binom{n+1}{n+1-i} \bar{\lambda}_n^k \text{ in } \mathbb{Z}[S_n],$$

$$e_n^{(i)} = \sum_{j=1}^n a_n^{i,j} l_n^j \text{ in } \mathbb{Q}[S_n] \text{ for } 1 \leq i \leq n,$$

where the Stirling numbers $a_n^{i,j}$ are defined by the identity $\sum_{i=1}^n a_n^{i,j} X^i = \binom{X-j+n}{n}$.

Proof. Let $\Delta^k : \mathcal{H} \rightarrow \mathcal{H}^{\otimes k}$ be the iterated comultiplication and $\mu^k : \mathcal{H}^{\otimes k} \rightarrow \mathcal{H}$ be the iterated multiplication. By definition we have $\bar{\lambda}^k = Id^{*k} = \mu^k \circ \Delta^k$. From the definition of Δ (cf. 4.5.4) we have

$$\Delta^k(a_1, \dots, a_n) = \sum (a_1, \dots, a_{p_1}) \otimes (a_{p_1+1}, \dots, a_{p_1+p_2}) \otimes \dots \otimes (a_{p_1+\dots+p_{k-1}+1}, \dots, a_{p_1+\dots+p_k})$$

where the sum is extended over all k -tuples of non-negative integers (p_1, \dots, p_k) such that $p_1 + \dots + p_k = n$. From the definition of μ (in terms of shuffles) we deduce that the coefficient of $\sigma \in S_n$ in the expression of $\bar{\lambda}_n^k$ as an element of $\mathbb{Z}[S_n]$ depends only on the number of descents of σ (a (p, q) -shuffle is either the identity or a permutation with one descent). By direct inspection we see that the coefficient of l_n^{k-i} in $\bar{\lambda}_n^k$ does not depend on k . We compute it for $k = i + 1$: since $l_n^{k-(k-1)} = l_n^1 = id$, this coefficient is the number of elements in the sum describing $\Delta^k(a_1, \dots, a_n)$ (see above). This number is precisely the binomial coefficient $\binom{n+k-1}{n}$ that is $\binom{n+i}{n}$.

The other formulas follow from classical combinatorial formulas. □

4.5.7 Corollary.

$$e_n^{(n)} = (1/n!) \sum_{\sigma \in S_n} \text{sgn}(\sigma)\sigma = (1/n!)\varepsilon_n .$$

Proof. From the definition of the Stirling numbers we get $a_n^{n,i} = 1/n!$ for all i , whence the result. □

In low dimensions the explicit form of $e_n^{(i)}$ is:

$$\begin{aligned} n = 1, \quad e_1^{(1)} &= id, \\ n = 2, \quad e_2^{(1)} &= \frac{1}{2}(id + (12)), \quad e_2^{(2)} = \frac{1}{2}\varepsilon_2 = \frac{1}{2}(id - (12)), \\ n = 3, \quad e_3^{(1)} &= \frac{1}{3}id - \frac{1}{6}((123) + (132) - (12) - (23)) - \frac{1}{3}(13), \\ e_3^{(2)} &= \frac{1}{2}(id + \omega_3), \quad e_3^{(3)} = \frac{1}{6}\varepsilon_3 . \end{aligned}$$

4.5.8 Hochschild Complex and Eulerian Idempotents. From now on we suppose that A is a commutative unital algebra and M a symmetric bimodule. The aim of the following proposition is to compare the action of the Hochschild boundary map b on $C(A, M) = M \otimes T'(A)$ and the operations introduced above. The λ -operations $\bar{\lambda}_n^k$ are extended to $C_n(A, M) = M \otimes A^{\otimes n}$ by $id_M \otimes \bar{\lambda}_n^k$ but still denoted simply by $\bar{\lambda}_n^k : C_n(A, M) \rightarrow C_n(A, M)$, and similarly for the operators $e_n^{(k)}$ and l_n^k .

4.5.9 Proposition. *Under the above hypothesis the following commutation properties hold for all $n \geq 1$:*

$$(4.5.9.1) \quad b\bar{\lambda}_n^k = \bar{\lambda}_{n-1}^k b ,$$

$$(4.5.9.2) \quad be_n^{(k)} = e_{n-1}^{(k)} b .$$

$$(4.5.9.3) \quad bl_n^k = (l_{n-1}^k - l_{n-1}^{k-1}) b .$$

Proof. It is sufficient to prove these formulas for $M = A$. Since $\bar{\lambda}^k = \mu^k \circ \Delta^k$ on $T'(A)$ it suffices to show that the map b on $C(A) = A \otimes T'(A)$ and $b \otimes 1_{T'(A)} + 1_{T'(A)} \otimes b$ on $A \otimes T'(A) \otimes T'(A)$ commute with $1_A \otimes \Delta$ and $1_A \otimes \mu$. For Δ it is immediate by direct inspection. For μ this is precisely Proposition 4.2.2. This shows that $\bar{\lambda}^k b = b \bar{\lambda}^k$.

For (4.5.9.2) one can either use the same method or deduce it from (4.5.9.1) by the same argument as in the proof of 4.5.3. Note that the particular case

$$be_n^{(n)} = e_{n-1}^{(n)} b = 0$$

was already proved in 1.3.5 since $e_n^{(n)} = (1/n!) \varepsilon_n$ by 4.5.7.

Formula (4.5.9.3) is a consequence of (4.5.9.1) and Proposition 4.5.6. \square

4.5.10 Theorem (λ -Decomposition for Hochschild Homology). *Suppose that k contains \mathbb{Q} , that the k -algebra A is commutative and that the A -bimodule M is symmetric. Then the idempotents $e_n^{(i)}$ naturally split the Hochschild complex $C_*(A, M)$ into a sum of sub-complexes $C_*^{(i)}$, $i \geq 0$, whose homology are denoted by $H_n^{(i)}(A, M)$ (and $HH_n^{(i)}(A)$ when $M = A$). Therefore*

$$H_0(A, M) = H_0^{(0)}(A, M) ,$$

$$H_n(A, M) = H_n^{(1)}(A, M) \oplus \dots \oplus H_n^{(n)}(A, M) , \quad \text{when } n \geq 1 .$$

Proof. For $n \geq 0$ we put $C_n^{(i)} := e_n^{(i)} C_n$ (image in C_n of the projector $e_n^{(i)}$). We remark that under the symmetry hypothesis the map $b : C_1 \rightarrow C_0$, $(m, a) \mapsto (am - ma)$ is trivial. Since $e_0^{(0)} = id$ this gives the formula for $n = 0$.

Then for $n \geq 1$ we get $C_n = C_n^{(1)} \oplus \dots \oplus C_n^{(n)}$ as a consequence of formulas 4.5.3. By formula (4.5.9.2) each $C_*^{(i)}$ is a subcomplex, and in fact a direct summand of C_* . Hence $C_* = \bigoplus_{i \geq 0} C_*^{(i)}$. Taking the homology gives the announced decomposition. \square

4.5.12 Theorem. *Under the above hypothesis there is a canonical isomorphism*

$$\varepsilon_n : M \otimes_A \Omega_{A|k}^n \cong H_n^{(n)}(A, M) \quad \text{and in particular} \quad \Omega_{A|k}^n \cong HH_n^{(n)}(A) .$$

Proof. We prove the case $M = A$ in order to simplify the notation. We use freely the notation and results of Sect. 1.3. By Corollary 4.5.7, $C_n^{(n)} = \text{Im } e_n^{(n)} = \text{Im } \varepsilon_n \cong A \otimes A^n A$, and since $e_{n-1}^{(n)} = 0$ one has $C_{n-1}^{(n)} = 0$. Hence $HH_n^{(n)}$ is a quotient of $\text{Im } \varepsilon_n$ (image of ε_n in C_n). Therefore the map $\varepsilon_n : \Omega_{A|k}^n \rightarrow HH_n^{(n)}(A)$ is surjective. Since it is also injective (split by π_n , cf. Proposition 1.3.16) it is an isomorphism. \square

4.5.13 Proposition. *If k contains \mathbb{Q} and A is flat over k , then the piece $HH_n^{(1)}$ coincides with Harrison-André-Quillen homology:*

$$HH_n^{(1)}(A) = D_{n-1}(A) = \text{Harr}_n(A) ,$$

and more generally (with the notation of Sect. 3.5):

$$HH_n^{(i)}(A) = D_{n-i}^{(i)}(A) = H_n(I^i/I^{i+1}) .$$

Proof. Let L_* be a simplicial resolution of A as a k -algebra. Then $HH_*(A)$ is the homology of the bicomplex L_{**} , where $L_{pq} = L_p^{\otimes q+1}$ (cf. proof of 3.5.8). Since for any i the algebra L_i is free over k , the i th column is quasi-isomorphic to the i th column of the complex $\Omega_{L_*}^*$, which has trivial vertical differential.

The idempotents $e_*^{(i)}$, which split the complex $C_*(A)$, split also the bicomplex L_{**} accordingly. Since $\Omega_{L_j|k}^i$ is mapped into $e_*^{(i)} L_j^{\otimes i+1}$ (cf. 4.5.12), it is clear that finally $C_*^{(i)}(A)$ is quasi-isomorphic to the complex $\Omega_{L_*|k}^i[i]$. Whence the isomorphism between $HH_n^{(i)}$ and $D_{n-i}^{(i)}$. The second one follows from the first and from the relationship between shuffles and Eulerian idempotents (cf. below and Ronco [1992a] for details). \square

4.5.14 Proposition. *The λ -decomposition of Hochschild homology is compatible with the shuffle product:*

$$HH_p^{(i)} \times HH_q^{(j)} \rightarrow HH_{p+q}^{(i+j)} .$$

Proof. From the description of μ in terms of shuffles (cf. 4.5.4.1), it is clear that $\bar{\lambda}^k = \mu^k \circ \Delta^k$ commutes with the shuffle product. Then, by (4.5.4.3) $_k$ the shuffle product is compatible with the Eulerian idempotents, hence with the λ -decomposition (cf. Ronco [1992a] for details). \square

4.5.15 λ -Filtration in Characteristic Free Context. If the ground ring k does not contain \mathbb{Q} (for instance in positive characteristic) one cannot use the Eulerian idempotents anymore. However since the λ -operations are elements of $\mathbb{Z}[S_n]$ one can still define a filtration $F_i^\gamma C_n$ (called the γ -filtration) on Hochschild homology, such that $\bar{\lambda}^k$ acts by multiplication by k^i on the graded associated module $F_i^\gamma C_* / F_{i+1}^\gamma C_*$ (more details can be found in Loday [1989]).

4.5.16 λ -Ring Theory. These λ -operations, more precisely $\lambda^k = (-1)^{k-1} \overline{\lambda}^k$, pertain to the theory of λ -rings (cf. for instance Atiyah-Tall [1969]) which has its roots in the properties of the exterior power functor. Here the involved ring structure on $H_*(A, M)$ is trivial (the product of any two elements is 0). As a consequence the Adams operations are given by $\Psi^k = (-1)^{k-1} k \lambda^k = k \overline{\lambda}^k$. However it can be shown that in a certain context (see Sect.10.6) they are actually restrictions of λ -operations on a non-trivial λ -ring (actually $HL_*(gl(A))$, see Exercise E.10.6.4).

4.5.17 The Non-Commutative Case. Suppose that the ground ring k contains \mathbb{Q} but that the k -algebra A is not necessarily commutative. Then the chain module $C_n = M \otimes A^{\otimes n}$ can still be decomposed into the direct sum of n pieces $C_n^{(i)}$ and the map b becomes an $(n-1, n)$ -matrix. If A were commutative and M symmetric, then this matrix would be diagonal (only one non-zero term in each row). This is formula (4.5.9.2). It is not true in general. However in characteristic zero the last piece $C_n^{(n)}$ can be identified with $M \otimes A^n$. Proposition 1.3.5 implies that the image of $C_n^{(n)}$ by b is contained in $C_{n-1}^{(n-1)}$ and that the restriction of b to $M \otimes A^n$ is simply the boundary map of the Chevalley-Eilenberg complex (hence only the Lie algebra structure of A is in effect).

Exercises

E.4.5.1. Let $\text{sgn} : \mathbb{Q}[S_n] \rightarrow \mathbb{Q}$ be the k -linear map which extends the sign map. Show that

$$\text{sgn}(\overline{\lambda}_n^k) = k^n, \quad \text{sgn}(e_n^{(i)}) = 0 \quad \text{if } i \neq n \quad \text{and} \quad \text{sgn}(e_n^{(n)}) = 1.$$

Deduce from this some combinatorial properties of the Eulerian numbers. [Apply 4.5.1 and 4.5.2 to $\mathcal{H} = T'(\mathbb{Z})$ viewed as a non-graded commutative Hopf algebra. The restriction of Id^{*k} to $\mathcal{H}_n = \mathbb{Z}$ in this framework is simply the multiplication by a scalar which is precisely $\text{sgn}(\overline{\lambda}_n^k)$. Any linear map $f : T'(\mathbb{Z}) \rightarrow T'(\mathbb{Z})$ is given by a family of scalars $f_n, n \geq 0$. Since the number of $(i, n-i)$ -shuffles is the binomial coefficient $\binom{n}{i}$ one gets

$$(f * g)_n = \sum_{i=0}^n \binom{n}{i} f_i g_{n-i} .]$$

E.4.5.2. Show that

$$e_n^{(1)} = \frac{1}{n} \sum_{k=1}^n \binom{n-1}{k-1}^{-1} (-1)^{k-1} l_n^k, \quad e_n^{(n-1)} = \frac{1}{2(n-1)!} \sum_{k=1}^n (n+1-2k) l_n^k .$$

Show that

$$\sum_{k=1}^n (-1)^{k-1} e_n^{(k)} = (-1)^{(n-1)(n-2)/2} \omega_n .$$

E.4.5.3. Show that the dimension of the representation $e_n^{(i)}$ of S_n is the coefficient of $1 = l_n^1$ in the expression of $n!e_n^{(i)}$ in terms of the l_n^k 's, that is

$$\sum_i \left(\dim e_n^{(i)} \right) q^i = q(q+1) \dots (q+n-1)$$

(cf. Reutenauer [1986], Hanlon [1990]).

E.4.5.4. With the hypothesis of 4.5.8 let $f_n \in \mathbb{Q}[S_n], n \geq 1$ be a family of elements which commute with b , i.e. $bf_n = f_{n-1}b$. Show that

$$f_n = \text{sgn}(f_1)e_n^{(1)} + \dots + \text{sgn}(f_i)e_n^{(i)} + \dots + \text{sgn}(f_n)e_n^{(n)} .$$

(Show first that $bf_n = 0$ implies $f_n = \text{sgn}(f_n)e_n^{(n)}$. Cf. Gerstenhaber-Schack [1987].)

E.4.5.5. Let $\exp(X) = \sum_{k \geq 0} X^k/k!$ be the exponential power series. Let X_1, \dots, X_n be non commuting variables. Then

$$\exp(X_1)\exp(X_2)\dots\exp(X_n) = \exp\left(\sum_{k \geq 0} \Phi_k(X_1, \dots, X_n)\right)$$

where Φ_k is a non-commutative polynomial of total degree k . Let ϕ_n be the multilinear part of Φ_n . Show that

$$\phi_n(X_1, \dots, X_n) = \left(e_n^{(1)} \right) \cdot (X_1 X_2 \dots X_n) ,$$

with $\sigma \cdot (X_1 X_2 \dots X_n) = \text{sgn}(\sigma)(X_{\sigma(1)} X_{\sigma(2)} \dots X_{\sigma(n)})$.

Show that for two variables

$$\Phi_n(X, Y) = \sum_{i+j=n} \frac{1}{i!j!} \phi_n(X, \dots, X, Y, \dots, Y) .$$

(This result gives a new Campbell-Hausdorff formula which was found independently by Reutenauer [1986] and Strichartz [1987], see also Hain [1986].)

E.4.5.6. Eulerian Polynomials. The functions $A_n(t) = \sum_{k=1}^n \alpha_{n,k} t^{k-1}$, where $\alpha_{n,k}$ is the Eulerian number, are called the *Eulerian polynomials*. Show that

$$1 + \sum_{n \geq 1} \frac{u^n}{n!} A_n(t) = \frac{1-t}{-t + \exp(u(1-t))} .$$

4.6 λ -Decomposition for Cyclic Homology

In the previous section we introduced idempotents $e_n^{(i)}$ which commute with the Hochschild boundary. The miracle is that these idempotents behave well with Connes' boundary operator B , that is

$$Be_n^{(i)} = e_{n+1}^{(i+1)} B .$$

This property allows us to show that cyclic homology splits naturally as a sum of smaller pieces in the commutative case:

$$HC_n(A) = HC_n^{(1)}(A) \oplus \dots \oplus HC_n^{(n)}(A) .$$

First we show how the Eulerian idempotents behave with respect to the norm operator N_n . This result permits us to prove the formula above and the decomposition of cyclic homology. Then we compare this decomposition with Harrison-André-Quillen homology, differential forms and de Rham homology. It turns out that the decomposition obtained in the computation of cyclic homology of a smooth algebra coincides with the λ -decomposition.

In the characteristic free context the decomposition has to be replaced by a filtration.

Concerning the symmetric group the notation is as in Sect. 4.5. Concerning cyclic homology the notation is as in Chap. 2. The main reference for this section is Loday [1989].

4.6.1 Eulerian Decomposition of S_n and Cyclic Descents. The aim of the first paragraphs of this section is to prove Theorem 4.6.6 about the behavior of the λ -operations and the Euler idempotents with respect to Connes' boundary map.

Let $\text{desc}(\sigma)$ be the number of descents of σ plus 1, so that $\text{desc}(\sigma) = k \Leftrightarrow \sigma \in S_{n,k}$ (cf. 4.5.5). By definition the *cyclic descent number* $\text{cdesc}(\sigma)$ of $\sigma \in S_{n,k}$ is k if $\sigma(1) > \sigma(n)$ and $k + 1$ if $\sigma(n) > \sigma(1)$. The important property about this invariant is that it depends only on the cycle $((\sigma(1)\sigma(2) \dots \sigma(n))$. In other words $\text{cdesc}(\sigma) = \text{cdesc}(\tau^j \sigma \tau^i)$ for any i and j .

Let us denote by $S_{n,k}^0$ (resp. $S_{n,k}^1$) the subset of $S_{n,k}$ made of elements for which $\text{cdesc} = \text{desc}$ (resp. $\text{cdesc} = \text{desc} + 1$):

k	1	...	k	...	n
$\text{cdesc} = \text{desc}$	\emptyset	...	$S_{n,k}^0$...	$\{\omega_n\}$
$\text{cdesc} = \text{desc} + 1$	$\{id\}$...	$S_{n,k}^1$...	\emptyset

In accordance with this splitting of $S_{n,k}$ one introduces the following elements of $\mathbb{Z}[S_n]$,

$$l_n^{k,0} := \sum_{\sigma \in S_{n,k}^0} \operatorname{sgn}(\sigma)\sigma \quad \text{and} \quad l_n^{k,1} := \sum_{\sigma \in S_{n,k}^1} \operatorname{sgn}(\sigma)\sigma,$$

so that $l_n^k = l_n^{k,0} + l_n^{k,1}$.

4.6.2 Lemma. $l_n^{k,0}\omega_n = (-1)^{n(n-1)/2}l_n^{n-k+1,1}$.

Proof. We already know that $S_{n,k}\omega_n = S_{n,n-k+1}$ (cf. 4.5.5). If $\sigma(1) > \sigma(n)$, then $\sigma\omega_n(1) = \sigma(n) < \sigma(1) = \sigma\omega_n(n)$ and so $S_{n,k}^0\omega_n = S_{n,n-k+1}^1$. Then the formula follows from $\operatorname{sgn}(\omega_n) = (-1)^{n(n-1)/2}$. \square

4.6.3 Notation. Let us change slightly our way of looking at S_n by letting it act on $\{0, 1, \dots, n-1\}$. Then S_{n-1} is viewed as a subgroup of S_n by letting it act on $\{1, \dots, n-1\}$. If $\sigma \in S_{n-1}$, then its image in S_n is denoted by $\tilde{\sigma}$, so $\tilde{\sigma}(0) = 0$. Accordingly any element in $\mathbb{Q}[S_{n-1}]$ gives rise to an element of $\mathbb{Q}[S_n]$ which is denoted by the same symbol with a \sim (tilde) on top. Recall that in Chap. 2 we introduced the norm operator

$$N_n = \sum_{i=0}^{n-1} \operatorname{sgn}(\tau^i)\tau^i \in \mathbb{Z}[S_n] \quad \text{where} \quad \tau = (0 \ 1 \ \dots \ n-1).$$

4.6.4 Lemma. $l_n^{k,1}N_n = N_n k \tilde{l}_{n-1}^k$.

Proof. The idea of the proof is simply to establish a bijection between the terms appearing on the left and those appearing on the right of the formula.

First we prove that for any pair (i, σ) , $\sigma \in S_{n,k}^1$ and $0 \leq i \leq n-1$, there exist a unique integer j , $0 \leq j \leq n-1$, and a unique permutation $\omega \in S_{n-1,k}$ such that $\sigma\tau^i = \tau^j\tilde{\omega}$. Indeed there exists a unique integer j such that $\tau^{-j}\sigma\tau^i(1) = (1)$. Put $\tilde{\omega} = \tau^{-j}\sigma\tau^i$, then $\tilde{\omega}(1) = 1$ and ω is well-defined. By hypothesis $\sigma \in S_{n,k}^1$, so $\operatorname{cdesc}(\sigma) = \operatorname{desc}(\sigma) + 1 = k + 1$. We deduce $\operatorname{desc}(\omega) = \operatorname{desc}(\tilde{\omega}) = \operatorname{cdesc}(\tilde{\omega}) - 1 = \operatorname{cdesc}(\tau^{-j}\sigma\tau^i) - 1 = \operatorname{cdesc}(\sigma) - 1 = k$. So $\omega \in S_{n-1,k}$ as expected.

In the other direction, fix the pair (j, ω) , $0 \leq j \leq n-1$, $\omega \in S_{n-1,k}$. Then $\operatorname{cdesc}(\tau^j\tilde{\omega}) = k$ and there are k different values (and only k) of i , $0 \leq i \leq n-1$, such that $\sigma = \tau^j\tilde{\omega}\tau^{-i}$ is in $S_{n,k}^1$ (These i 's correspond to the positions of the cyclic descents). This gives a bijection between $S_{n,k}^1$ and k copies of $S_{n-1,k}$.

In conclusion, formula 4.6.4 holds since the signs involved are the signs of the permutations. \square

4.6.5 Lemma. $l_n^{k,0}N_n = N_n(n-k+1)\tilde{l}_{n-1}^{k-1}$.

Proof. This formula is a consequence of Lemmas 4.6.2 and 4.6.4. Indeed one has

$$\begin{aligned} l_n^{k,0} N_n &= \operatorname{sgn}(\omega_n) \omega_n l_n^{n-k+1,1} N_n = \operatorname{sgn}(\omega_n) \omega_n N_n (n-k+1) \tilde{l}_{n-1}^{n-k+1} \\ &= N_n (n-k+1) \operatorname{sgn}(\omega_{n-1}) \tilde{\omega}_{n-1} \tilde{l}_{n-1}^{n-k+1} = N_n (n-k+1) \tilde{l}_{n-1}^{k-1}. \quad \square \end{aligned}$$

We are now in position to prove the following

4.6.6 Theorem. *Let A be a commutative k -algebra and $B : \overline{C}_{n-1}(A) \rightarrow \overline{C}_n(A)$ Connes' boundary map (in the normalized setting). Then*

$$\overline{\lambda}_n^k B = B k \overline{\lambda}_{n-1}^k.$$

If moreover k contains \mathbb{Q} , then $e_n^{(k)} B = B e_{n-1}^{(k-1)}$.

Proof. Putting Lemmas 4.6.4 and 4.6.5 together gives

$$(4.6.6.1) \quad l_n^k N_n = N_n \left(k \tilde{l}_{n-1}^k + (n-k+1) \tilde{l}_{n-1}^{k-1} \right).$$

From the definition of $\overline{\lambda}$ in terms of l (cf. 4.5.6) it follows that

$$(4.6.6.2) \quad \overline{\lambda}_n^k N_n = N_n k \overset{\sim}{\lambda}_{n-1}^k.$$

In the normalized setting one has $B = sN_n$, where $s(a_0, \dots, a_{n-1}) = (1, a_0, \dots, a_{n-1})$ (cf. 2.1.9). Remark that the action of S_n on $C_{n-1}(A) = A \otimes A^{\otimes n-1} = A^{\otimes n}$, which is involved here, is given by

$$\sigma.(a_0, a_1, \dots, a_{n-1}) = (a_{\sigma^{-1}(0)}, a_{\sigma^{-1}(1)}, \dots, a_{\sigma^{-1}(n-1)}).$$

The first formula of Theorem 4.6.6 follows from (4.6.6.2).

The second formula is a consequence of the first by the same argument as in the proof of 4.5.3. □

4.6.7 Theorem (λ -Decomposition for Cyclic Homology). *If k contains \mathbb{Q} and if the unital k -algebra A is commutative, then the bicomplex $\overline{B}(A)$ breaks up naturally into a sum of subcomplexes $\overline{B}(A)^{(i)}$, $i \geq 0$, whose homology are denoted by $HC_*^{(i)}(A)$.*

Therefore

$$\begin{aligned} HC_0(A) &= HC_0^{(0)}(A) \quad \text{and} \\ HC_n(A) &= HC_n^{(1)}(A) \oplus \dots \oplus HC_n^{(n)}(A), \quad \text{when } n \geq 1. \end{aligned}$$

Proof. Let C_* denote the normalized Hochschild complex. Let $\overline{B}^{(i)}$ be the bicomplex which has $C_*^{(i)} = e_*^{(i)} C_*$ in the first column (numbered 0), $C_*^{(i-1)}$ in the second, etc. By Theorem 4.6.6 we can put the restriction of B as horizontal differential:

$\overline{B}(A)^{(i)} :$

$$\begin{array}{ccccccc}
 & & \downarrow & & \downarrow & & \downarrow \\
 i+1 & C_{i+1}^{(i)} & \leftarrow & C_i^{(i-1)} & \leftarrow & \dots & \leftarrow C_2^{(1)} & \leftarrow & 0 \\
 & \downarrow & & \downarrow & & & \downarrow & & \\
 i & C_i^{(i)} & \leftarrow & C_{i-1}^{(i-1)} & \leftarrow & \dots & \leftarrow C_1^{(1)} & \leftarrow & C_0^{(0)} \\
 & \downarrow & & \downarrow & & & \downarrow & & \\
 i-1 & 0 & \leftarrow & 0 & \leftarrow & \dots & \leftarrow 0 & \leftarrow & 0 \\
 & \vdots & & & & & & & \\
 & 0 & & & & & & &
 \end{array}$$

It is immediate that $\overline{B}(A) = \bigoplus_{i \geq 0} \overline{B}^{(i)}(A)$. For $i = 0$, $\overline{B}^{(0)}(A)$ is concentrated in bidegree $(0, 0)$, whence $HC_0(A) = HC_0^{(0)}(A) = A$. For $n \geq 1$, there are only n pieces: $HC_n^{(1)}(A), \dots, HC_n^{(n)}(A)$, since $C_n^{(i)}$ is non-zero only for $1 \leq i \leq n$ (cf. the shape of $\overline{B}^{(i)}(A)$ above). \square

4.6.8 Theorem. *Under the above hypothesis there are canonical isomorphisms*

and

$$\begin{aligned}
 HC_n^{(n)}(A) &\cong \Omega_{A|k}^n / d\Omega_{A|k}^{n-1} \quad \text{for } n \geq 0, \\
 HC_n^{(1)}(A) &\cong \text{Harr}_n(A) \quad \text{for } n \geq 3.
 \end{aligned}$$

For $n = 2$, there is a short exact sequence

$$0 \rightarrow \text{Harr}_2(A) \rightarrow HC_2^{(1)}(A) \rightarrow H_{\text{DR}}^0(A) \rightarrow 0.$$

Proof. Consider the bicomplex $\overline{B}^{(i)}(A)$ for $i = n$. By definition $HC_n^{(n)}(A)$ is the quotient of $C_n^{(n)}$ by the image of b and of B . By 4.5.12 the cokernel of $b : C_{n+1}^{(n)} \rightarrow C_n^{(n)}$ is $\Omega_{A|k}^n$ and by 2.3.4 the map B induces d (up to an invertible scalar) on these cokernels. Hence $HC_n^{(n)}(A) \cong \Omega_{A|k}^n / d\Omega_{A|k}^{n-1}$.

For $i = 1$, $\overline{B}(A)^{(1)}$ has the following shape

$$\begin{array}{ccc}
 & \downarrow & \\
 3 & C_3^{(1)} & \\
 & \downarrow & \\
 2 & C_2^{(1)} & \\
 & \downarrow & \\
 1 & C_1^{(1)} & \leftarrow C_0^{(0)} \\
 & \downarrow & \\
 0 & 0 &
 \end{array}$$

So it is immediate that $HC_n^{(1)}(A) \cong HH_n^{(1)}(A) \cong \text{Harr}_n(A)$ for $n \geq 3$ (cf. 4.5.13). The presence of $C_0^{(0)}$ in this bicomplex implies a modification for $n < 3$. The expected exact sequence follows from the exact sequence of complexes

$$0 \rightarrow C_*/C_0^{(0)} \rightarrow \text{Tot } \bar{\mathcal{B}}(A)^{(1)} \rightarrow C_0^{(0)}[2] \rightarrow 0$$

and the fact that B induces $d : A \rightarrow \Omega_{A|k}^1$ on $C_0^{(0)}$. □

4.6.9 Theorem. *Under the above hypothesis Connes' exact sequence splits into the sum over i of the following exact sequences:*

$$\begin{aligned} \dots \rightarrow HH_n^{(i)}(A) &\xrightarrow{I} HC_n^{(i)}(A) \xrightarrow{S} HC_{n-2}^{(i-1)}(A) \xrightarrow{B} HH_{n-1}^{(i)}(A) \rightarrow \dots \\ \dots \rightarrow HC_{i+1}^{(i)}(A) &\rightarrow \Omega_{A|k}^{i-1}/d\Omega_{A|k}^{i-2} \rightarrow \Omega_{A|k}^i \rightarrow \Omega_{A|k}^i/d\Omega_{A|k}^{i-1} \rightarrow 0. \end{aligned}$$

Proof. The bicomplex $\bar{\mathcal{B}}^{(i)}(A)$ gives rise to an exact sequence of bicomplexes

$$0 \rightarrow C_*^{(i)} \rightarrow \bar{\mathcal{B}}^{(i)}(A) \rightarrow \bar{\mathcal{B}}^{(i-1)}(A)[2] \rightarrow 0,$$

where $C_*^{(i)}$ is considered as a bicomplex concentrated in the first column. Then it suffices to take the homology. The identification of the last part of the exact sequence with the forms is deduced from 4.5.12, 4.6.8 and 2.3.4. □

4.6.10 Theorem. *When A is smooth the λ -decomposition coincides with the decomposition in terms of de Rham cohomology (cf. 2.3.7 and 3.4.12):*

$$\begin{aligned} HC_n^{(n)}(A) &= \Omega_{A|k}^n/d\Omega_{A|k}^{n-1}, \\ HC_n^{(i)}(A) &= H_{\text{DR}}^{2i-n}(A), \quad \text{for } [n/2] \leq i < n, \\ HC_n^{(i)}(A) &= 0, \quad \text{for } i < [n/2]. \end{aligned}$$

In particular, for $A = k$, $HC_{2n}(k) = HC_{2n}^{(n)}(k) \cong H_{\text{DR}}^0(k) = k$.

Proof. The map π (cf. 2.3.6) from the bicomplex $\bar{\mathcal{B}}(A)$ to the bicomplex of truncated de Rham complexes sends the component $\bar{\mathcal{B}}(A)^{(i)}$ to the bicomplex consisting of row number i solely (cf. 4.5.12). Whence the result. □

4.6.11 Remark. For any commutative algebra A there is a sequence of maps

$$\dots \rightarrow HC_{n+2j}^{(n+j)}(A) \xrightarrow{S} HC_{n+2j-2}^{(n+j-1)}(A) \rightarrow \dots \rightarrow HC_{n+2}^{(n+1)}(A) \rightarrow H_{\text{DR}}^n(A)$$

which happen to be isomorphisms when A is smooth. Each group $HC_{n+2j}^{(n+j)}(A)$ is, in a certain sense, a generalization of de Rham homology. Little is known about these groups in the non-smooth case.

4.6.12 λ -Filtration in the Characteristic Free Context. As in Hochschild homology, when k does not contain \mathbb{Q} , one can replace the graduation of $\overline{B}(A)$ by a filtration. This is a consequence of the first formula of Theorem 4.6.6. Thus $HC_*(A)$ inherits a filtration and Connes' exact sequence is consistent with this filtration (see details in Loday [1989]).

Exercises

E.4.6.1. Show that the λ -operations and the splittings extend to HC^- , HC^{per} (cf. 5.1), HD , HQ (cf. 5.2), even in the case of a non-unital algebra.

E.4.6.2. Show that the product $*$ on cyclic homology sends $HC_p^{(i)} \times HC_q^{(j)}$ into $HC_{p+q+1}^{(i+j+1)}$ (cf. Ronco [1992a]).

E.4.6.3. Signed Eulerian Numbers. Let

$$\beta_{n,k} = \sum_{\sigma \in S_{n,k}} \text{sgn}(\sigma).$$

Use 4.5.9.3 and then 4.6.5 to prove the equalities

$$\begin{aligned} \beta_{2n,k} &= \beta_{2n-1,k} - \beta_{2n-1,k-1}, \\ \beta_{2n+1,k} &= k\beta_{2n,k} + (2n - k + 2)\beta_{2n,k-1}. \end{aligned}$$

Deduce from these formulas that the *signed Eulerian polynomial* $B_n(t) = \sum_{1 \leq k \leq n} \beta_{n,k} t^{k-1}$ satisfies $B_{2n}(t) = (1-t)^n A_n(t)$ and $B_{2n+1}(t) = (1-t)^n A_{n+1}(t)$ where $A_n(t)$ was defined in Exercise E.4.5.6. (Compare with Désarménien-Foata [1992].)

E.4.6.4. Let $\eta = \eta_n = \sum_{\sigma \in S_n} \sigma$. Show that $\lambda_n^k \eta_n = (-1)^{k-1} k^{\lfloor (n+1)/2 \rfloor} \eta_n$. Deduce that $\eta_n \in \text{Im } e_n^{\lfloor (n+1)/2 \rfloor}$. (Use the preceding exercise, cf. Loday [1989].)

E.4.6.5. Let k be a characteristic zero field and $A = k[x, y, z]/\{\text{degree } 2 \text{ polynomials}\}$. Show that $(x \otimes y \otimes z)$ defines a non-trivial element $\ll x, y, z \gg$ in $HC_2(A)$. Show that $\ll x, y, z \gg = \ll y, z, x \gg$ and that the two elements $\ll x, y, z \gg$ and $\ll x, z, y \gg$ are linearly independent. Show that $HC_2^{(1)}(A)$ and $HC_2^{(2)}(A)$ are both of dimension 1 over k . Find explicit generators. (They are $\frac{1}{2}(\ll x, y, z \gg \pm \ll x, z, y \gg)$. Compare with similar symbols in algebraic K -theory, cf. Loday [1981].)

E.4.6.6. Künneth Sequence and λ -Decomposition. Show that the Künneth sequence 4.3.12 for commutative rings (or the Künneth sequence 4.3.11 for functors from the category **Fin**, cf. Sect. 6.4) over a characteristic zero ring k is compatible with the λ -decomposition. [Since the Künneth sequence is Connes periodicity exact sequence of some cyclic module, it suffices by 4.6.9 to check that this is in fact a **Fin**-module.]

Bibliographical Comments on Chapter 4

§1. All the basic formulas for the action of a derivation are already in Rinehart [1963, section 9 and 10]. Some of them have been rediscovered independently by Connes [C] and Goodwillie [1985a] (via the acyclic model method technique). For instance the fundamental formula (4.1.8.2) is in p. 220 in Rinehart [1963] and p. 124 in Connes [C]. The application to nilpotent ideals is in Goodwillie [1985a].

§2. The shuffle product is a classical matter and can be found in any textbook on homological algebra or algebraic topology.

§3–4. The product in cyclic homology appeared first in Loday-Quillen [LQ]. Then I discovered the cyclic shuffles (and so did Getzler-Jones [1990]), while trying to make it more explicit. But then I found out that it was already in Rinehart [1963]. The product is also studied in Hood-Jones [1987] by means of the acyclic model method, and there extended to negative and periodic cyclic homology. The Künneth exact sequence appeared simultaneously in Burghelea-Ogle [1986], Feigin-Tsygan [FT], Hood-Jones [1987], Karoubi [1986c], Kassel [1986]. The product in cyclic cohomology is in Connes [C]. An interesting relationship with Chen iterated integrals appeared in Getzler-Jones-Petrack [1991].

§5–6. The decomposition in Hochschild homology follows from a spectral sequence in Quillen [1970]. This paper also contains the relation with André-Quillen homology and differential forms but in the cohomological framework. The point is that Quillen does not use the bar resolution. The first appearance of the idempotent $e^{(1)}$ in connection with Hochschild homology seems to be in Hain [1986]. The Eulerian idempotents and the splitting of HH are in Gerstenhaber-Schack [1987]. They also appear in Loday [1989] where several of their properties are shown, namely the integrality of the λ -operations and the splitting of cyclic homology (see also Natsume-Schack [1989]). The relationship with the exterior power operations of $H_*(gl)$ follows from Loday-Procesi [1989]. Slightly different formulas can be found in Feigin-Tsygan [FT]. The relationship with DGA -algebras (which also implies the decomposition of HC) is in Burghelea-Vigué [1988] (method close to that of Quillen).

Subsequent work can be found in Ronco [1992] (where it is shown that all the decompositions are the same), in Burghelea-Fiedorowicz-Gajda [1991, 1992], Gerstenhaber-Schack [1991] (Hopf algebra point of view, also communicated by Cartier [unpublished]), Hanlon [1990], Vigué-Poirrier [1991a], Nuss [1991].

Chapter 5. Variations on Cyclic Homology

There are several ways of modifying cyclic homology: by altering the cyclic bicomplex, by putting up other groups than the cyclic groups or by enlarging the category of algebras.

By taking advantage of the horizontal periodicity of the cyclic bicomplex, it is immediate to see how to extend it on the left. This gives rise to a new theory which is called *periodic cyclic homology* and denoted HC^{per} . This theory is really the analog in the non-commutative framework of the de Rham cohomology theory. Between HC^{per} and HC fits another theory: negative cyclic homology, denoted HC^- , which is dual to cyclic homology if considered as a module over the polynomial algebra $k[u]$ rather than just k . Moreover the negative cyclic homology is the right receptacle for the Chern character (generalization of the Dennis trace map) as will be seen later. The study of HC^{per} and HC^- is done in Sect. 5.1.

It is tempting to look for other families of groups playing the same role as the family of cyclic groups with respect to the Hochschild complex. Though the general case will be treated in Sect. 6.3 entitled “Crossed simplicial groups”, we study here the case of dihedral groups and quaternionic groups. They give rise to dihedral homology and quaternionic homology denoted HD and HQ respectively. The importance of these theories is their relationship with the homology of the orthogonal and symplectic Lie algebras as will be seen later in Sect. 10.5. They are a natural receptacle for invariants of quadratic forms (generalization of the Arf invariant). Their study, though similar to that of HC , is slightly more complicated since the periodicity phenomenon is of period 4 instead of 2. This is the content of Sect. 5.2.

Enlarging the category of k -algebras on which HC is defined can be done in many different ways: graded algebras, simplicial algebras, etc. We choose to work out the differential graded algebra case since it arises naturally in different sorts of problems. As already seen earlier, the computation of HH and HC of tensor algebras and symmetric algebras is well-known. The point here is that any k -algebra is equivalent to a DG -algebra whose underlying algebra is a (graded) tensor algebra or a (graded) symmetric algebra in the commutative case. What really happens is that all the complications of the ring structure have been transferred to the differential of the DG -algebra. Since equivalent algebras have same HH and HC homology, this gives a way

of computing many examples. The general case is handled in Sect. 5.3 and the commutative case in Sect. 5.4.

For any homology-cohomology theories there is a way of treating them together by defining a bivariant theory. This is also the case for HH and HC . Section 5.5 is devoted to bivariant cyclic cohomology.

For many applications, in particular in the study of the Novikov conjecture, the relevant k -algebra is in fact a Banach algebra (with $k = \mathbb{C}$) and it is important to keep track of the topology. So the definitions of HH and HC need to be slightly modified to achieve this goal. Moreover one can use the topology to construct sharper invariants, in fact a new theory called: *entire cyclic homology*. Section 5.6 gives a brief account of it.

5.1 The Periodic and Negative Theories

The dual over k of cyclic cohomology is cyclic homology. However if one considers cyclic cohomology as a graded $k[v]$ -module (where $k[v] = HC^*(k)$), then its dual is a new theory called *negative cyclic homology* which is denoted HC_*^- . This theory is easily constructed from the cyclic bicomplex by using the periodicity structure. The “difference” between HC_*^- and HC_* is a theory which is periodic of period 2, denoted HC_*^{per} and called *periodic cyclic homology*. It is a generalization of the de Rham cohomology theory to non-commutative algebras, since it coincides precisely with de Rham cohomology for smooth algebras.

Most of the results of this section are taken out of Hood-Jones [1987], Jones [1987] and Goodwillie [1985]. In the first mentioned paper the authors point out wisely that there is a nice analogy which helps to understand the relationship between these variations of cyclic homology. It is given by the following tableau:

$H^*(-, \mathbb{Z})$	HC^*	coeff = $k[v]$,
$H_*(-, \mathbb{Z})$	HC_*^{per}	coeff = $k[u]$, $u = v^{-1}$,
$H_*(-, \mathbb{Q})$	HC_*^-	coeff = $k[u, u^{-1}]$,
$H_*(-, \mathbb{Q}/\mathbb{Z})$	HC_*	coeff = $k[u, u^{-1}]/uk[u]$.

In this section $C = (C_n)_{n \geq 0}$ is a cyclic module (cf. 2.5.1) with face maps d_i , degeneracy maps s_j , and cyclic operator t (including sign). As usual we put $b = \sum_{i=0}^n (-1)^i d_i$, $b' = \sum_{i=0}^{n-1} (-1)^i d_i$, $N = 1 + t + \dots + t^n$, and $B = (1 - t)s_N$ where $s = (-1)^n t s_n$ is the extra degeneracy.

5.1.1 Periodic and Negative Cyclic Bicomplexes. The following double complex, indexed by $\mathbb{Z} \times \mathbb{N}$, is called the *periodic cyclic bicomplex*:

$$\begin{array}{ccccccc}
 & & -b' \downarrow & & b \downarrow & & -b' \downarrow \\
 \dots & \leftarrow & C_2 & \xleftarrow{N} & C_2 & \xleftarrow{1-t} & C_2 & \xleftarrow{N} & \dots \\
 & & -b' \downarrow & & b \downarrow & & -b' \downarrow \\
 \dots & \leftarrow & C_1 & \xleftarrow{N} & C_1 & \xleftarrow{1-t} & C_1 & \xleftarrow{N} & \dots \\
 & & -b' \downarrow & & b \downarrow & & -b' \downarrow \\
 \dots & \leftarrow & C_0 & \xleftarrow{N} & C_0 & \xleftarrow{1-t} & C_0 & \xleftarrow{N} & \dots \\
 \text{column\#} & & -1 & & 0 & & 1 & & \dots
 \end{array}$$

The horizontal differentials are alternatively $(1 - t)$ and N and the vertical complexes are either the b -complex or the b' -complex. By deleting all the negatively numbered columns one gets the usual bicomplex CC . By deleting all the columns whose number is ≥ 2 one gets the *negative cyclic bicomplex* that we denote by CC^- .

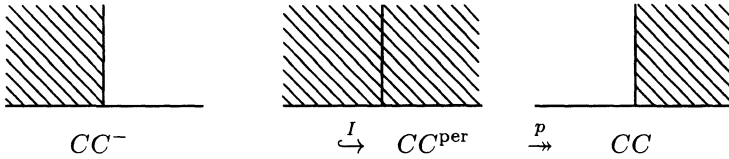

(Note that this is not an exact sequence since all these bicomplexes have columns number 0 and 1 in common). These two maps induce $I : HC_n^- \rightarrow HC_n^{\text{per}}$ and $p : HC_n^{\text{per}} \rightarrow HC_n$ respectively.

5.1.2 The Total Complexes. There was no problem to form the total complex of CC since for fixed n there is only a finite number of non-zero modules CC_{pq} with $p + q = n$. However for CC^- and CC^{per} it is not the case anymore and we have the choice between taking the *sum* or the *product* of all these modules. If we take the sum, then the homology of CC^{per} is trivial rationally since all the horizontal lines have zero homology (cf. remark after 2.1.5). So we take the product.

Let us denote by ToT CC^{per} the complex whose term of degree n is $\prod_{p+q=n} CC_{pq}^{\text{per}}$ and whose differential is the total differential induced by $(1 - t, -b')$ and (N, b) . (Remark that deleting the letter o in ToT gives TT which is almost Π). This is a periodic complex of period 2, equal to $\prod_{i \geq 0} C_i$ in degree n .

Similarly the complex ToT CC^- is such that its term of degree n is $\prod_{p+q=n} CC_{pq}^-$, that is $\prod_{i \geq n-1} C_i$.

5.1.3 Definition of HC^- and HC^{per} . Let C be a (pre-)cyclic module. Then *periodic cyclic homology* and *negative cyclic homology* of C are respectively

$$HC_n^{\text{per}}(C) := H_n(\text{ToT } CC^{\text{per}}) \text{ and } HC_n^-(C) := H_n(\text{ToT } CC^-), \quad n \in \mathbb{Z}.$$

As usual, when $C = C(A)$, where A is a k -algebra, we write $HC_*^{\text{per}}(A) = \bigoplus_{n \geq 0} HC_n^{\text{per}}(A)$ and $HC_*^-(A) = \bigoplus_{n \geq 0} HC_n^-(A)$ instead of $HC_*^{\text{per}}(C(A))$ and $HC_*^-(C(A))$ respectively. In some papers HC^{per} is denoted HP or HCP . The maps I and p of 5.1.1 induce the natural transformations $I : HC_n^- \rightarrow HC_n^{\text{per}}$ and $p : HC_n^{\text{per}} \rightarrow HC_n^-$.

5.1.4 First Properties. For $A = k$ we get $HC_{2n}^{\text{per}}(k) = k$ and $HC_{2n-1}^{\text{per}}(k) = 0$ for any n , and

$$\begin{cases} HC_n^-(k) = 0 & \text{if } n > 0, \\ HC_{2n-1}^-(k) = 0 & \text{if } n \leq 0, \\ HC_{2n}^-(k) = k & \text{if } n \leq 0. \end{cases}$$

In the following we abbreviate $HC(C)$ into HC if no confusion can arise and similarly for the other theories (one can also think of HC as a functor from cyclic modules to graded modules). Recall that the generator of $HC_2(k)$ is denoted by u . The generator of $HC_{-2}^-(k)$ is denoted by v , so $HC_*^-(k)$ is isomorphic to the graded algebra $k[v]$ (the product structure will be dealt with in 5.1.13). If one still denotes by u and v the corresponding elements in $HC_2^{\text{per}}(k)$ and $HC_{-2}^{\text{per}}(k)$ respectively, then $uv = 1 \in k = HC_0^{\text{per}}(k)$.

(5.1.4.1) Let $h : HC_n^- \rightarrow HH_n$ be the map induced by the projection of CC^- onto $CC^{\{2\}}$ (last two columns, cf. proof of 2.2.1).

For HC^{per} the long periodicity exact sequence is an actual periodicity: $HC_{2n}^{\text{per}} \cong HC_{2n-2}^{\text{per}}$ and for HC^- it takes the form of an exact sequence

$$(5.1.4.2) \quad \dots \rightarrow HC_{n+2}^- \rightarrow HC_n^- \xrightarrow{h} HH_n \rightarrow HC_{n+1}^- \rightarrow \dots$$

Note also that for $n \leq 0$ one has $HC_n^{\text{per}} \cong HC_n^-$. More generally the exact sequence of bicomplexes

$$0 \rightarrow CC^- \rightarrow CC^{\text{per}} \rightarrow CC[0, 2] \rightarrow 0$$

gives the upper exact sequence of the following

5.1.5 Proposition. *For any (pre-)cyclic module C there is a canonical commutative diagram of long exact sequences:*

$$\begin{array}{cccccccc} \dots & \rightarrow & HC_{n-1} & \xrightarrow{B} & HC_n^- & \xrightarrow{I} & HC_n^{\text{per}} & \xrightarrow{S} & HC_{n-2} & \xrightarrow{B} & \dots \\ & & \downarrow id & & \downarrow h & & \downarrow p & & \downarrow id & & \\ \dots & \rightarrow & HC_{n-1} & \rightarrow & HH_n & \rightarrow & HC_n & \rightarrow & HC_{n-2} & \rightarrow & \dots \end{array}$$

□

Remark. We put pre-cyclic (cf. 2.5.6) in the hypotheses since CC^- , CC^{per} and CC do not need the degeneracies to be defined. So, for instance, $HC^-(A)$ and $HC^{\text{per}}(A)$ are well-defined even if the k -algebra A has no unit. Note that if A has a unit (i.e. if C is a cyclic module), then one can define CC^- by taking only the non-positively numbered columns.

5.1.6 Proposition. *Let $C \rightarrow C'$ be a map of cyclic modules which induces an isomorphism on HH . Then it also induces an isomorphism on HC^- and on HC^{per} (and of course on HC as already shown).*

Proof. Consider the map of bicomplexes $CC^{\text{per}} \rightarrow CC'^{\text{per}}$. Restricted to any column this map is a quasi-isomorphism. Since these bicomplexes are trivial for $q < 0$ one can apply the classical staircase argument (cf. 1.0.12). The same is true for CC^- . □

5.1.7 The Bicomplexes BC^- and BC^{per} . It is sometimes easier to work with the (b, B) -bicomplex BC associated to C which exists as soon as C has degeneracies (i.e. A is unital if $C = C(A)$), cf. 2.5.10. So let

$$\begin{array}{ccccccc}
 & & & & \dots & & \dots & \dots \\
 & & & & \downarrow & & \downarrow & \\
 & & & \dots & \leftarrow & C_1 & \leftarrow & C_0 \\
 & & & \downarrow & & \downarrow & & \\
 \dots & \leftarrow & C_1 & \leftarrow & C_0 & & & \\
 \downarrow & & \downarrow & & & & & \\
 C_1 & \leftarrow & C_0 & & & & & \\
 \dots & & & & & & &
 \end{array}$$

be the bicomplex constructed from B (horizontal differential) and b (vertical differential). By deleting the positively (resp. negatively) numbered columns one gets BC_{**} (resp. a new bicomplex denoted BC^-):

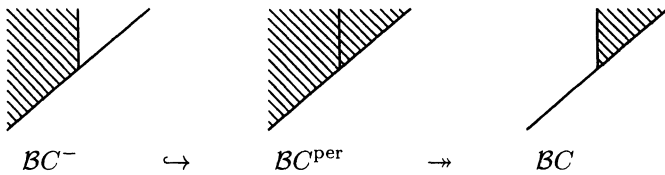

Applying the “killing contractible complexes Lemma” 2.1.6, it is immediate to check that

$$HC_n^{\text{per}}(C) = H_n(\text{ToT } BC^{\text{per}}) \quad \text{and} \quad HC_n^-(C) = H_n(\text{ToT } BC^-), \quad n \in \mathbb{Z},$$

and of course $HC_n(C) = H_n(\text{Tot } \mathcal{BC})$. It is sometimes useful to rewrite these complexes as follows. Let $\hat{\otimes} = \hat{\otimes}_k$ be the completed tensor product, that is $(C \hat{\otimes} C')_n := \prod_{p+q=n} C_p \otimes C'_q$. Consider C as a graded $k[v]$ -module, where v (which is of degree -2) acts on C by S . Then one has the following identifications:

$$\begin{aligned} \text{ToT } \mathcal{BC}^- &= k[v] \hat{\otimes} C, \\ \text{ToT } \mathcal{BC}^{\text{per}} &= k[v, v^{-1}] \hat{\otimes} C, \\ \text{Tot } \mathcal{BC} &= \text{ToT } \mathcal{BC}^{\text{per}} / v \text{ToT } \mathcal{BC}^- = k[v, v^{-1}] / vk[v] \otimes C. \end{aligned}$$

Remark. In fact negative cyclic homology and periodic cyclic homology can be defined by starting from any mixed complex (cf. 2.5.13), since the only properties that we have used to define the bicomplexes \mathcal{BC}^- and $\mathcal{BC}^{\text{per}}$ are $b^2 = B^2 = bB + Bb = 0$.

5.1.8 From HC^- to HC^{per} and then to HC . Let us summarize the relations between all these theories by a diagram. By working with the bicomplex $\mathcal{BC}^{\text{per}}$ these theories differ by the columns which are taken into account:

column#	...	-3	-2	-1	0	1	2	3	...
HH					×				
HC^-	...	×	×	×	×				
HC^{per}	...	×	×	×	×	×	×	×	...
$HC[-2]$				×	×	×	×	×	...
HC					×	×	×	×	...

Consequently there are natural maps between all these theories as follows:

$$\begin{aligned} HC_n^- &\xrightarrow{I} HC_n^{\text{per}} \rightarrow \lim_r HC_{n+2r} \rightarrow \dots \\ &\dots \rightarrow HC_{n+2r} \xrightarrow{S} HC_{n+2r-2} \rightarrow \dots \rightarrow HC_n, \\ &\text{and } h : HC_n^- \rightarrow HH_n. \end{aligned}$$

Remark that if we go on, then the map $HC_n^- \rightarrow HC_{n-2}$ that we get is trivial.

Both theories HC^{per} and $\lim_r HC_{n+2r}$ are periodic of period 2. Though they are isomorphic in many cases, there is in general an extra term:

5.1.9 Proposition. *For any cyclic module C there is an exact sequence*

$$0 \rightarrow \lim_r^1 HC_{n+2r+1} \rightarrow HC_n^{\text{per}} \rightarrow \lim_r HC_{n+2r} \rightarrow 0.$$

Proof. Consider the complex $\text{ToT } \mathcal{BC}^{\text{per}}$ as a projective limit of the complexes $K_{*,r} = (\text{Tot } \mathcal{BC}[-2r])_r$. Then by the universal coefficient theorem for the category of indices $\{\mathbb{Z}\}$, it comes out that the following sequence is exact:

$$\begin{aligned}
 0 \rightarrow \text{Ext}_{\{\mathbb{Z}\}}(k, r \mapsto H_{n+1}(K_{*,r})) &\rightarrow H_n(\lim K_{*,r}) \\
 &\rightarrow \text{Hom}_{\{\mathbb{Z}\}}(k, r \mapsto H_{n+1}(K_{*,r})) \rightarrow 0.
 \end{aligned}$$

Since $\text{Hom}_{\{\mathbb{Z}\}} = \lim^0 = \text{lim}$ and $\text{Ext}_{\{\mathbb{Z}\}} = \lim^1$ (cf. appendix C.10) the proposition is proved. \square

5.1.10 Vanishing of the \lim^1 -Term. When a projective system satisfies the Mittag-Leffler condition, then the \lim^1 -term is trivial (cf. appendix C.11). In particular this is the case when all the involved maps are surjective. For instance, when A is smooth then the periodicity map $S : HC_n(A) \rightarrow HC_{n-2}(A)$ is surjective and therefore $HC_n^{\text{per}} = \lim HC_{n+2r}(A)$. More generally suppose that $HC_*(A)$ is either a trivial $k[u]$ -comodule U or an extended $k[u]$ -comodule of the form $k[u] \otimes V$ (cf. 2.5.17 and 4.4.7). Then the Mittag-Leffler condition is fulfilled and $HC_n^{\text{per}} = \lim HC_{n+2r}$. See Exercise E.5.1.5 for an example where $HC_n^{\text{per}} \neq \lim HC_{n+2r}$.

5.1.11 Tensor Algebras. It is immediate from the computation of Sect. 3.1 that periodic cyclic homology of $A = T(V)$, where V is a free module over k is the homology of the periodic complex

$$\dots \longleftarrow A \xleftarrow{b} A \otimes V \xleftarrow{\gamma} A \xleftarrow{b} A \otimes V \longleftarrow \dots$$

It follows that

$$HC_0^{\text{per}}(T(V)) = HC_2(T(V)) \quad \text{and} \quad HC_1^{\text{per}}(T(V)) = HC_1(T(V)).$$

Remark that it can be expressed in terms of Tate homology (cf. Appendix C.4):

$$HC_n^{\text{per}}(T(V)) = HC_n^{\text{per}}(k) \oplus \bigoplus_{m>0} \hat{H}_n(\mathbb{Z}/m\mathbb{Z}, V^{\otimes m}).$$

5.1.12 Smooth Algebras. We follow the same argument as in the computation of cyclic homology of smooth algebras. Replacing the Hochschild complex by the module of forms and B by d gives immediately the following computation for A smooth over k containing \mathbb{Q} :

$$HC_0^{\text{per}}(A) = H_{\text{DR}}^{\text{ev}}(A) = \prod_{i \geq 0} H_{\text{DR}}^{2i}(A)$$

and

$$HC_1^{\text{per}}(A) = H_{\text{DR}}^{\text{odd}}(A) = \prod_{i \geq 0} H_{\text{DR}}^{2i+1}(A),$$

(cf. Sect. 3.4). So, periodic cyclic homology is a generalization of de Rham cohomology. Remark that HC_0^{per} comes equipped with a filtration by images of the operators S^i which corresponds to the natural splitting of $H_{\text{DR}}^{\text{ev}}$ (and similarly for HC_1^{per}). For negative cyclic homology we get

$$HC_n^-(A) \cong Z^n(A) \times \prod_{i>0} H_{\text{DR}}^{n+2i}(A),$$

where $Z^n(A) = \text{Ker}(d : \Omega_{A|k}^n \rightarrow \Omega_{A|k}^{n+1})$. The exact sequence of Proposition 5.1.5 decomposes as a product of short exact sequences:

$$\begin{array}{cccccccc}
 \dots & \rightarrow & HC_{n-1}^{\text{per}} & \rightarrow & HC_{n-1} & \rightarrow & HC_n^- & \rightarrow & HC_n^{\text{per}} & \rightarrow & HC_{n-2} & \rightarrow & \dots \\
 & & \parallel & & \parallel & & \parallel & & \parallel & & \parallel & & \\
 \dots & & \dots & & \dots & & \dots & & \dots & & \dots & & \\
 H_{\text{DR}}^{n-5} & = & H_{\text{DR}}^{n-5} & \rightarrow & 0 & \rightarrow & H_{\text{DR}}^{n-4} & = & H_{\text{DR}}^{n-4} & \rightarrow & & & \\
 \times & & \oplus & & & & \times & & \oplus & & & & \\
 H_{\text{DR}}^{n-3} & = & H_{\text{DR}}^{n-3} & \rightarrow & 0 & \rightarrow & H_{\text{DR}}^{n-2} & \hookrightarrow & \Omega^{n-2}/d\Omega^{n-3} & \rightarrow & & & \\
 \times & & \oplus & & & & \times & & & & & & \\
 H_{\text{DR}}^{n-1} & \hookrightarrow & \Omega^{n-1}/d\Omega^{n-2} & \rightarrow & Z^n & \rightarrow & H_{\text{DR}}^n & \rightarrow & 0 & & & & \\
 \times & & & & \times & & \times & & & & & & \\
 H_{\text{DR}}^{n+1} & \rightarrow & 0 & \rightarrow & H_{\text{DR}}^{n+2} & = & H_{\text{DR}}^{n+2} & \rightarrow & 0 & & & & \\
 \dots & & \dots & & \dots & & \dots & & \dots & & \dots & &
 \end{array}$$

5.1.13 Operations on HC^- and HC^{per} . Product and coproduct can be defined on HC^- and HC^{per} by using all the tools devised in Sects. 4.2 and 4.3. The proofs are similar to the HC case and are left to the diligent reader.

Let C and C' be two cyclic modules. Both mixed complexes $C \otimes C'$ and $C \times C'$ give rise to a “negative” bicomplex $\mathcal{B}(C \otimes C')^-$, respectively $\mathcal{B}(C \times C')^-$ (cf. remark after 5.1.7).

An n -chain in $\text{ToT } \mathcal{B}C^-$ is of the form

$$x = (x_n, x_{n+2}, x_{n+4}, \dots) \in C_n \times C_{n+2} \times \dots = \prod_{i \geq 0} C_{n+2i} = (\text{ToT } \mathcal{B}C^-)_n .$$

One defines a product $\times : (\text{ToT } \mathcal{B}C^-)_p \otimes (\text{ToT } \mathcal{B}C^-)_q \rightarrow (\text{ToT } \mathcal{B}(C \otimes C')^-)_{p+q}$ by the formula

$$\begin{aligned}
 x \times y &= (x_p \otimes y_q, x_p \otimes y_{q+2} + x_{p+2} \otimes y_q, \\
 &\quad x_p \otimes y_{q+4} + x_{p+2} \otimes y_{q+2} + x_{p+4} \otimes y_q, \dots) .
 \end{aligned}$$

Summing over p and q such that $p + q = n$ for fixed n gives a chain map

$$\times : \text{ToT } \mathcal{B}C^- \otimes \text{ToT } \mathcal{B}C'^- \rightarrow \text{ToT } \mathcal{B}(C \otimes C')^- .$$

The map $Sh^- = sh + sh'$ (in fact an infinite dimensional matrix with non-zero elements on two diagonals, cf. 2.5.14) defines a chain map from $\text{ToT } \mathcal{B}(C \otimes C')^-$ to $\text{ToT } \mathcal{B}(C \times C')^-$.

5.1.14 Proposition. *The composite $Sh^- \circ \times$ defines a natural product on negative cyclic homology*

$$\times : HC_p^-(C) \otimes HC_q^-(C') \rightarrow HC_{p+q}^-(C \times C') ,$$

which is associative and graded commutative. Moreover it is compatible with the shuffle product in Hochschild homology:

$$h(x \times y) = h(x) \times h(y) \quad \text{for } h : HC_*^- \rightarrow HH_*,$$

and with the product structure in cyclic homology:

$$B(x \times y) = B(x) \times B(y) \quad \text{for } B : HC_{*-1}^- \rightarrow HC_*^-. \quad \square$$

For $C = C' = C(k)$ the product structure inherited by $HC_*^-(k)$ makes it into an algebra isomorphic to $k[v]$, where v is the canonical generator of $HC_{-2}^-(k) = k$ (dual to the Bott generator in $HC^2(k)$, cf. below). Obviously the map $(- \times v) : HC_n^- \rightarrow HC_{n-2}^-$ is the periodicity operator S .

5.1.15 Other Products. Formal manipulations permit us to construct from the preceding construction $k[v]$ -bilinear graded products

$$\times : HC_*^{\text{per}}(C) \otimes HC_*^{\text{per}}(C') \rightarrow HC_*^{\text{per}}(C \times C'),$$

$$\times : HC_*^-(C) \otimes HC_*(C') \rightarrow HC_*(C \times C').$$

Under this product $HC_*^{\text{per}}(k)$ is isomorphic to the Laurent polynomial algebra $k[u, u^{-1}]$ where $u \in HC_2^{\text{per}}(k)$ and $u^{-1} = v \in HC_{-2}^{\text{per}}(k)$. Again for this last product the map $HC_n \rightarrow HC_{n-2}$ induced by $v \times -$ is the periodicity operator S .

5.1.16 Proposition. *For any cyclic modules C and C' , there is defined a coproduct map*

$$HC_*^-(C \times C') \rightarrow HC_*^-(C) \otimes_{k[v]} HC_*^-(C')$$

compatible with the coproduct in cyclic homology. □

Remark that on the right-hand side the tensor product is taken over the graded algebra $k[v] = HC_*^-(k)$.

5.1.17 Duality of HC^* and HC_*^- over $k[v]$. The functors HC^* and HC_* are dual as k -modules. However when one looks at HC^* as a $k[v]$ -module, then the following results show that the dual theory is HC_*^- . As a consequence it will be shown in Chap. 8 that the right receptacle for the Chern character coming from algebraic K -theory is HC_*^- .

5.1.18 Lemma. *The chain complex map*

$$\text{Tot } \mathcal{B}C^*(C) \rightarrow \text{Hom}_{k[v]}(\text{Tot } \mathcal{B}C_*^-(C), k[v])$$

is an isomorphism.

Proof. By definition a cochain in C^{n-2i} is a k -linear homomorphism $f_i : C_{n-2i} \rightarrow k$. A cochain in $\text{Tot } \mathcal{BC}^*(C)$ is a family $(f_i)_{i \geq 0}$. It gives rise to a $k[v]$ -map $\text{ToT } \mathcal{BC}_*^-(C) \rightarrow k[v]$ by $\Sigma v^j \otimes e_j \mapsto \Sigma f(e_j)v^{i+j}$. On the other hand a straightforward computation shows that any $k[v]$ -map from $\text{ToT } \mathcal{BC}_*^-(C)$ to $k[v]$ is precisely equivalent to this data. Whence the lemma. \square

5.1.19 Theorem. *Let C be a cyclic module over k . If C and $HC_*^-(C)$ are free over k (for instance if k is a field), then there is a natural short exact sequence*

$$0 \rightarrow \text{Ext}_{k[v]}(HC_*^-(C), k[v])_{n+1} \rightarrow HC^n(C) \rightarrow \text{Hom}_{k[v]}(HC_*^-(C), k[v])_n \rightarrow 0.$$

Proof. This is a consequence of Lemma 5.1.18 and a standard homological argument. \square

5.1.20 λ -Decomposition of HC^{per} and HC^- . Suppose that k contains \mathbb{Q} and that A is commutative. Since the Hochschild complex splits according to the λ -operations and this splitting is compatible with the B map (cf. Sects. 4.5 and 4.6), it is immediate that both complexes \mathcal{BC}^- and $\mathcal{BC}^{\text{per}}$ split. This gives a splitting for HC^- and HC^{per} which is compatible with the computation performed for smooth algebras (cf. 5.1.12).

Exercises

E.5.1.1. Show that for any exact sequence of cyclic modules

$$0 \rightarrow C' \rightarrow C \rightarrow C'' \rightarrow 0$$

there is an exact sequence for periodic cyclic homology

$$\dots \rightarrow HC_n^{\text{per}}(C') \rightarrow HC_n^{\text{per}}(C) \rightarrow HC_n^{\text{per}}(C'') \rightarrow HC_{n-1}^{\text{per}}(C') \rightarrow \dots$$

and similarly for negative cyclic homology.

E.5.1.2. Show that when A is smooth over k , then the identification of HC^- with H_{DR} transforms the product on HC^- into the natural product of forms on H_{DR} (cf. Hood-Jones [1987, ex. 2.10]).

E.5.1.3. Let k be a field and A, A' be unital k -algebras. Assume that the Mittag-Leffler condition is fulfilled for $HC_*(A')$ (cf. 5.1.10). Show that there is an isomorphism

$$HC_*^{\text{per}}(A) \otimes_{k[v]} HC_*^{\text{per}}(A') \cong HC_*^{\text{per}}(A \otimes A'),$$

and an exact sequence

$$\begin{aligned}
 0 \rightarrow (HC_*^-(A) \otimes_{k[v]} HC_*^-(A'))_n &\rightarrow HC_n^-(A \otimes A') \\
 &\rightarrow \text{Tor}_{k[v]}(HC_*^-(A), HC_*^-(A'))_{n-1} \rightarrow 0.
 \end{aligned}$$

(Cf. Hood-Jones [1987, Thm 3.1] and Kassel [1987, Thm 3.10].)

E.5.1.4. Suppose that k contains \mathbb{Q} . Show that HC_*^{per} is homotopy invariant:

$$HC_*^{\text{per}}(A[x]) \cong HC_*^{\text{per}}(A),$$

and that

$$\begin{aligned}
 HC_*^{\text{per}}(A[x, x^{-1}]) &\cong HC_*^{\text{per}}(A) \oplus HC_{*-1}^{\text{per}}(A), \\
 HC_*^{\text{per}}(A[x]/P(x)) &\cong HC_*^{\text{per}}(A)^r,
 \end{aligned}$$

where $P(x)$ is a polynomial with coefficients in k with r distinct roots in an extension of k (cf. Kassel [1987, §3]).

E.5.1.5. Show that for $k = \mathbb{Z}$ and $A = \mathbb{Z}[\mathbb{Z}/p\mathbb{Z}]$, where p is a prime number, $HC_0^{\text{per}}(A)$ does not coincide with $\lim_r HC_{2r}(A)$. More precisely show that $\lim^1 HC_{2r}(\mathbb{Z}[\mathbb{Z}/p\mathbb{Z}])$ is isomorphic to the sum of $(p-1)$ copies of \mathbb{Z}_p/\mathbb{Z} where \mathbb{Z}_p is the ring of p -adic integers. (Use Sect. 7.4, see Kassel [1989b].)

5.2 Dihedral and Quaternionic Homology

If the algebra A is equipped with an involution, then the Hochschild complex and the cyclic bicomplex split into two parts (provided that 2 is invertible in k) and so do HH_* and HC_* . A nice way of reinterpreting this result is to introduce the dihedral group D_n and its two actions on the module $A^{\otimes n}$, whence two theories: *dihedral homology* denoted HD_* and *skew-dihedral homology* denoted HD'_* . They are such that $HC = HD \oplus HD'$. One of the main reason for studying dihedral homology is its close relationship with the homology of the orthogonal matrix algebras and the symplectic matrix algebras (cf. Sect. 10.5).

The hypothesis $1/2 \in k$ makes the treatment of dihedral homology analogous to that of cyclic homology since there exists a periodic resolution (of period 4) for D_n . If one wants to get rid of this hypothesis, then it is still possible to define dihedral and skew-dihedral homology but the method is more complicated. One clever way, due to J. Lodder, is sketched in Exercise E.5.2.4. Another way, more geometric in nature and giving the same result, will be treated in Chap. 6.

In fact there is still another possibility which gives even finer invariants: use the quaternion groups Q_n instead of D_n . Then one can define quaternionic homology without having to assume that 2 is invertible since there exists a periodic resolution (of period 4) for Q_n . This quaternionic theory plays an important role in constructing invariants for quadratic forms.

Almost all that was done for cyclic homology in the previous chapters can be carried out for dihedral homology and quaternionic homology as

well: Morita invariance, generalization to non-unital algebras, mixed complex interpretation, cohomological versions, dihedral and quaternionic modules, computation for tensor algebras, smooth algebras, universal enveloping algebras, existence of operations, Künneth formulas, λ -decomposition, periodic and negative theories, relation with $O(2)$ -spaces and $\text{Pin}(2)$ -spaces (cf. Chap. 7), etc. (Some of these topics have been treated in the literature, some not). In general the proofs are of the same flavour as their counterpart in cyclic homology, however passing from cyclic theory to quaternionic theory is not completely formal. For instance in Connes' periodicity exact sequence Hochschild homology has to be replaced by a new theory denoted HT_* . Another example showing the kind of complications which comes in is the case of group algebras: the involved geometric realizations are far more complicated in the dihedral case (cf. Sect. 7.3).

This section is taken out from Loday [1987a].

Standing Assumptions. Throughout this section the k -algebra A is equipped with an involution $a \mapsto \bar{a}$. This means that $\overline{\bar{a}} = a$ and $\overline{ab} = \bar{b}\bar{a}$. We always assume that this involution is trivial on k , in particular $\bar{1} = 1$. The element \bar{a} is called the *conjugate* of a . Such an algebra will be called *involutive*.

The most common examples of involutive k -algebras are

- (a) A is commutative and $\bar{a} = a$,
- (b) $A = k[G]$, where G is a group, and $\bar{g} = g^{-1}$ for $g \in G$,
- (c) for any involutive k -algebra R the algebra $A = \mathcal{M}(R)$ (matrices over R) is involutive: $\bar{\alpha}$ is the conjugate transposed matrix of α ,
- (d) $A = U(\mathfrak{g})$, where \mathfrak{g} is a Lie algebra, and $\bar{g} = -g$ for $g \in \mathfrak{g}$,
- (e) $A = R \times R^{\text{op}}$, where R is a k -algebra, and $\overline{(r, s)} = (s, r)$.

5.2.1 Involution on the Hochschild Complex. Let M be an A -bimodule equipped with a map $m \mapsto \bar{m}$ such that $\overline{\bar{m}} = m$ and $\overline{am} = \bar{a}\bar{m}$ for any $m \in M$ and any $a, a' \in A$ (e.g. $M = A$). Then M is said to be an *involutive A -bimodule*. There is defined on $C_n(A, M) = M \otimes A^{\otimes n}$ an involution ω_n by the following formula

$$\omega_n(m, a_1, \dots, a_n) = (\bar{m}, \bar{a}_n, \bar{a}_{n-1}, \dots, \bar{a}_1).$$

So this involution consists in applying a permutation and replacing each entry by its conjugate. Note that the sign of the involved permutation is $(-1)^{n(n+1)/2}$. It will prove helpful to introduce the notation

$$y_n = (-1)^{n(n+1)/2} \omega_n.$$

5.2.2 Lemma. *For any $i, 0 \leq i \leq n$, one has the equality $d_i \omega_n = \omega_{n-1} d_{n-i}$ and therefore*

$$b \omega_n = (-1)^n \omega_{n-1} b.$$

Proof. Both operators $d_i\omega_n$ and $\omega_{n-1}d_{n-i}$ applied to (a_0, \dots, a_n) give $(\bar{a}_0, \bar{a}_n, \dots, \bar{a}_{n-i}\bar{a}_{n-i-1}, \dots, \bar{a}_1)$. As a consequence

$$b\omega_n = \sum_{i=0}^n (-1)^i d_i\omega_n = (-1)^n \omega_{n-1} \sum_{i=0}^n (-1)^{n-i} d_{n-i} = (-1)^n \omega_{n-1} b. \quad \square$$

5.2.3 Proposition. *If the k -algebra A and the A -bimodule M are involutive and if $1/2 \in k$, then Hochschild homology splits up into a direct sum*

$$H_*(A, M) = H_*^+(A, M) \oplus H_*^-(A, M),$$

and when $M = A$, $HH_*(A) = HH_*^+(A) \oplus HH_*^-(A)$.

Proof. Let $y_n = (-1)^{n(n+1)/2}\omega_n$ act on $C_n = C_n(A, M)$. Since $(y_n)^2 = id$ and $1/2 \in k$, C_n splits into $C_n^+ \oplus C_n^-$ where C_n^\pm is the eigenspace of the eigenvalue ± 1 (i.e. the image of the projector $1/2(1 \mp y_n)$). By Lemma 5.2.2 we get $by_n = y_{n-1}b$ and the complex (C_*, b) splits into the direct sum of two complexes $(C_*^+, b) \oplus (C_*^-, b)$. Then it suffices to put $H_*^\pm(A, M) = H_*(C_*^\pm, b)$. □

5.2.4 Example. Suppose that A is commutative with trivial involution and that M is symmetric, i.e. $am = ma$ for all $a \in A$ and all $m \in M$. Then $H_0^+(A, M) = M$, $H_0^-(A, M) = 0$ and $H_1^+(A, M) = 0$, $H_1^-(A, M) = M \otimes \Omega_{A|k}^1$.

More generally if k contains \mathbb{Q} we know (cf. Sect. 4.5) that HH_n splits up as $HH_n^{(0)} \oplus \dots \oplus HH_n^{(n)}$. An immediate consequence of the last formula of Exercise E.4.5.3 are the following equalities:

$$(5.2.4.1) \quad \begin{aligned} HH_n^+ &= HH_n^{(0)} \oplus HH_n^{(2)} \oplus \dots \quad \text{and} \\ HH_n^- &= HH_n^{(1)} \oplus HH_n^{(3)} \oplus \dots \end{aligned}$$

In particular $\Omega_{A|k}^{2n} \subset HH_{2n}^+(A)$ and $\Omega_{A|k}^{2n-1} \subset HH_{2n-1}^-(A)$. Therefore if A is smooth, then

$$\begin{cases} HH_{2n}^+(A) = \Omega_{A|k}^{2n}, & HH_{2n-1}^+(A) = 0, \\ HH_{2n}^-(A) = 0, & HH_{2n-1}^-(A) = \Omega_{A|k}^{2n-1}. \end{cases}$$

5.2.5 The Dihedral Group. The comparison of the action of $\tau_n = (-1)^n t_n$ and ω_n on C_n shows that $\omega_n \tau_n \omega_n^{-1} = \tau_n^{-1}$. The group presented by $\{\tau_n, \omega_n \mid \tau_n^{n+1} = \omega_n^2 = 1 \text{ and } \omega_n \tau_n \omega_n^{-1} = \tau_n^{-1}\}$ is the *dihedral group* D_{n+1} of order $2(n+1)$. Note that it contains two elements of order 2: ω_n and $\omega_n \tau_n$. The latter one acts on C_n by

$$\omega_n \tau_n(a_0, \dots, a_n) = (\bar{a}_n, \bar{a}_{n-1}, \dots, \bar{a}_0).$$

5.2.6 Lemma. *Let $t_n = (-1)^n \tau_n$, $y_n = (-1)^{n(n+1)/2} \omega_n$ and $z_n = (-1)^{n(n-1)/2} \omega_n \tau_n$, then*

$$\begin{aligned}
 by_n &= y_{n-1}b, & b'z_n &= z_{n-1}b' \quad \text{and} \\
 y_n(1 - t_n) &= (1 - t_n)z_n, & z_n N &= -Ny_n.
 \end{aligned}$$

Proof. The first equality was already proved in Lemma 5.2.2. The second one is a consequence of Lemma 5.2.2 and 2.5.1.1. For the last formula recall that $N = 1 + t_n + \dots + t_n^{n-1}$. These formulas are immediate to check. \square

Consider the cyclic bicomplex $CC = CC(A)$ described in 2.1.2. Let us define an involution on this bicomplex by letting $(-1)^i y$ operate on column number $2i$ (more precisely $(-1)^i y_n$ operates on $C_n(A)$) and $(-1)^i z$ operate on column number $2i + 1$. By Lemma 5.2.6 this is a well-defined involution which splits up CC into $CC^+ \oplus CC^-$ (remember that $1/2 \in k$)

$$\begin{array}{ccccccc}
 CC^+ : & \dots & & \dots & & \dots & & \dots \\
 & \downarrow & & \downarrow & & \downarrow & & \downarrow \\
 & C_1^- & \xleftarrow{1-t} & C_1^+ & \xleftarrow{N} & C_1^- & \xleftarrow{1-t} & C_1^+ & \xleftarrow{N} \\
 & b \downarrow & & -b' \downarrow & & b \downarrow & & -b' \downarrow \\
 & C_0^- & \xleftarrow{1-t} & C_0^+ & \xleftarrow{N} & C_0^- & \xleftarrow{1-t} & C_0^+ & \xleftarrow{N}
 \end{array}$$

Remark that for CC^+ column number 0 is (C_*^-, b) and, similarly, for CC^- column number 0 is (C_*^+, b) (the bicomplex CC^- described here is *not* the bicomplex CC^- used to define negative cyclic homology and I apologize for this contradiction of notation).

5.2.7 Definition. Let A be an involutive algebra over k (which is supposed to contain $1/2$). Then *dihedral homology* of A (resp. *skew-dihedral homology* of A) is

$$HD_n(A) := H_n(\text{Tot } CC^+(A)) \quad (\text{resp. } HD'_n(A) := H_n(\text{Tot } CC^-(A))).$$

The choice for HD and HD' is different from the one made in Loday [1987a]. The motivation for this new choice is, first, that the product $HC_p \times HC_q \rightarrow HC_{p+q+1}$ sends $HD_p \times HD_q$ to HD_{p+q+1} , $HD_p \times HD'_q$ to HD'_{p+q+1} and finally $HD'_p \times HD'_q$ to HD_{p+q+1} . Second, it will be shown later that the computation of the homology of the Lie algebra of orthogonal matrices (and also symplectic matrices) is related to HD (and not to HD').

It follows immediately from the above definition that there is a canonical splitting of cyclic homology

$$(5.2.7.1) \quad HC_n(A) = HD_n(A) \oplus HD'_n(A) \quad \text{for all } n.$$

Connes' periodicity exact sequence also splits up naturally into the direct sum of the following two exact sequences:

$$(5.2.7.2) \quad \dots \rightarrow HH_n^- \rightarrow HD_n \rightarrow HD'_{n-2} \rightarrow HH_{n-1}^+ \rightarrow HD'_{n-1} \\ \rightarrow HD_{n-3} \rightarrow HH_{n-2}^- \rightarrow \dots$$

$$(5.2.7.3) \quad \dots \rightarrow HH_n^+ \rightarrow HD'_n \rightarrow HD_{n-2} \rightarrow HH_{n-1}^- \rightarrow HD_{n-1} \\ \rightarrow HD'_{n-3} \rightarrow HH_{n-2}^+ \rightarrow \dots$$

As for Hochschild homology, when k contains \mathbb{Q} , this splitting is coherent with the λ -decomposition studied in Sect. 4.6:

$$HD_n = HC_n^{(1)} \oplus HC_n^{(3)} \oplus \dots, \quad \text{and} \quad HD'_n = HC_n^{(0)} \oplus HC_n^{(2)} \oplus \dots$$

In the bicomplex $CC^+(A)$ the cokernel of the map of complexes $CC_1^+ \rightarrow CC_0^+$ is a complex whose n th term is a quotient of $A^{\otimes n+1}$ by the action of the dihedral group D_{n+1} acting by t and y (for CC^- replace y by $-y$). So we get the following

5.2.8 Theorem. *Suppose that k contains \mathbb{Q} and let A be an involutive k -algebra. Then dihedral homology $HD_*(A)$ (resp. skew-dihedral homology $HD'_*(A)$) is canonically isomorphic to the homology of the complex $(C(A)/(1-t, 1-y), b)$ (resp. $(C(A)/(1-t, 1+y), b)$) obtained by factoring out the Hochschild complex by the action of the dihedral group.*

Proof. By Lemma 5.2.6 Connes' complex $C_*^\lambda(A)$ (cf. 2.1.4) is split by y into the sum of the two complexes referred to above. This splitting is obviously compatible, via the projection map from $\text{Tot } CC(A)$ to $C^\lambda(A)$, with the splitting of $CC(A)$; whence the result. \square

Remark that in the bicomplex $CC^+(A)$ the homology of row number n is the group $H_*(D_{n+1}, A^{\otimes n+1})$ (cf. Appendix C), where the dihedral group acts on $A^{\otimes n+1}$ by t and y . Since D_n is finite, rationally these homology groups are 0 except for $*$ = 0 for which it is precisely $A^{\otimes n+1}/(1-t, 1+y)$. This gives a slightly different proof of Theorem 5.2.8.

We now deal with quaternionic homology. We do not assume that 2 is invertible anymore. First some information on quaternion groups and their resolutions is in order.

5.2.9 Quaternion Group. Let $Q_n = \{\tau, \omega \mid \omega^2 = \tau^n, \omega\tau\omega^{-1} = \tau^{-1}\}$ be the quaternion group of order $4n$. Remark that the two relations imply $\omega\tau^n\omega^{-1} = \tau^{-n}$, that is $\omega\omega^2\omega^{-1} = \omega^{-2}$, i.e. $\tau^{2n} = \omega^4 = 1$. The main advantage of Q_n over D_n is that, as a trivial module, k possesses a periodic resolution (of period 4). These two groups are related via a central extension

$$1 \rightarrow \mathbb{Z}/2\mathbb{Z} \rightarrow Q_n \rightarrow D_n \rightarrow 1.$$

5.2.10 Proposition. *The following is a 4-periodic resolution of the trivial Q_n -module k :*

$$\dots \xrightarrow{\alpha} k[Q_n] \xrightarrow{N} k[Q_n] \xrightarrow{\gamma} k[Q_n]^2 \xrightarrow{\beta} k[Q_n]^2 \xrightarrow{\alpha} k[Q_n] \xrightarrow{\varepsilon} k \rightarrow 0,$$

where $\varepsilon =$ augmentation, $\alpha = [1 - \tau, 1 - \omega]$,

$$\beta = \begin{bmatrix} L & 1 + \tau\omega \\ -(1 + \omega) & \tau - 1 \end{bmatrix}, \quad \gamma = \begin{bmatrix} 1 - \tau \\ \omega\tau - 1 \end{bmatrix},$$

$$L = 1 + \tau + \dots + \tau^{n-1}, \quad N = \sum_{g \in Q_n} g = (1 + \omega + \omega^2 + \omega^3) L.$$

Proof (Sketch). A presentation of a group by generators and relations gives rise to the beginning of a resolution (cf. appendix C, Exercise E.C.1). In the particular case of Q_n it gives the exact sequence

$$(5.2.10.1) \quad k[Q_n]^2 \xrightarrow{\beta} k[Q_n]^2 \xrightarrow{\alpha} k[Q_n] \xrightarrow{\varepsilon} k \rightarrow 0,$$

By applying the functor $\text{Hom}_{k[Q_n]}(-, k[Q_n])$ to this sequence and modifying the Q_n -module structure of these modules by using the isomorphism $\phi, \phi(\tau) = \tau^{-1}, \phi(\omega) = (\tau\omega)^{-1}$, one gets (after rearranging the signs) an exact sequence

$$(5.2.10.2) \quad k[Q_n]^2 \xleftarrow{\beta} k[Q_n]^2 \xleftarrow{\gamma} k[Q_n] \xleftarrow{\varepsilon^{**}} k \leftarrow 0,$$

It turns out that the composition $\varepsilon^{**} \circ \varepsilon$ is precisely N , so the expected resolution consists in splicing copies of (5.2.10.1) and (5.2.10.2). \square

When A is involutive then $A^{\otimes n}$ is a Q_n -module since there is a canonical surjection from Q_n to D_n . This is an example of a quaternionic module whose general definition is the following:

5.2.11 Quaternionic Modules. A *quaternionic* (resp. *dihedral*) module is a simplicial module equipped for all n with an action of Q_{n+1} (resp. D_{n+1}) on C_n satisfying the following formulas

$$d_i \tau_n = \tau_{n-1} d_{i-1}, \quad s_i \tau_n = \tau_{n+1} s_{i+1} \quad \text{for } 1 \leq i \leq n,$$

$$d_i \omega_n = \omega_{n-1} d_{n-i}, \quad s_i \omega_n = \omega_{n+1} s_{n-i} \quad \text{for } 0 \leq i \leq n,$$

with $d_i : C_n \rightarrow C_{n-1}$ and $s_i : C_n \rightarrow C_{n+1}$, $\tau_n \in Q_{n+1}$ and $\omega_n \in Q_{n+1}$ (resp. D_{n+1}).

As in the cyclic case these formulas imply that

$$d_0 \tau_n = d_n \quad \text{and} \quad s_0 \tau_n = \tau_{n+1}^2 s_n.$$

Here we did not include the signs in the definition. The definition with signs is obtained by the formulas

$$x_n = (-1)^n \tau_n \quad \text{and} \quad y_n = (-1)^{n(n+1)/2} \omega_n .$$

Any involutive k -algebra A gives rise to a quaternionic module (resp. dihedral module) $C(A)$ through the following formulas

$$\begin{aligned} \tau_n(a_0, \dots, a_n) &= (a_n, a_0, \dots, a_{n-1}) \\ \omega_n(a_0, \dots, a_n) &= (\bar{a}_0, \bar{a}_n, \dots, \bar{a}_1) . \end{aligned}$$

It is easy to check that what we have done for the particular dihedral module $C = C(A)$ in the first part of this section can be performed for any quaternionic (resp. dihedral) module. Remark also that $HD'(A)$ is just dihedral homology of the dihedral module $C'(A)$ which is like $C(A)$ but with the action of ω changed into $-\omega$. In the sequel we just sketch quaternionic homology, leaving the details to the reader (with the aid of the literature).

5.2.12 Proposition. *Let C_n be a quaternionic module and let ζ be a 4th power root of unity in k . The following is a well-defined bicomplex, periodic of period 4 horizontally, and denoted QC_{**}^ζ (or simply QC^ζ)*

$$\begin{array}{ccccccc} \dots & & \dots & & \dots & & \dots \\ \downarrow & & \downarrow & & \downarrow & & \downarrow \\ C_n & \xleftarrow{\alpha} & C_n \oplus C_n & \xleftarrow{\beta} & C_n \oplus C_n & \xleftarrow{\gamma} & C_n & \xleftarrow{N} \dots \\ b \downarrow & & -(b' \oplus b) \downarrow & & b \oplus b' \downarrow & & -b' \downarrow & \\ C_{n-1} & \xleftarrow{\alpha} & C_{n-1} \oplus C_{n-1} & \xleftarrow{\beta} & C_{n-1} \oplus C_{n-1} & \xleftarrow{\gamma} & C_{n-1} & \xleftarrow{N} \dots \\ \downarrow & & \downarrow & & \downarrow & & \downarrow & \\ \dots & & \dots & & \dots & & \dots & \end{array}$$

with

$$\begin{aligned} \alpha &= [1 - x, 1 + y] , \quad \beta = \begin{bmatrix} L & 1 - xy \\ -1 + y & x - 1 \end{bmatrix} , \quad \gamma = \begin{bmatrix} 1 - x \\ -yx - 1 \end{bmatrix} , \\ L &= 1 + x + \dots + x^{n-1} , \quad N = (1 + y + y^2 + y^3)L \quad \text{and} \\ x_n &= (-1)^n \tau_n , \quad y_n = (-1)^{n(n+1)/2} \zeta \omega_n . \end{aligned}$$

Proof. It is a consequence of the following relations whose proofs are left to the reader

- (a) $b(1 - x) = (1 - x)b' ,$
- (b) $by = yb ,$
- (c) $b'xy = xyb' ,$
- (d) $b'L = Lb ,$
- (e) $b'N = Nb .$

□

5.2.13 Quaternionic Homology. Let C be a quaternionic module and ζ be a 4th root of unity in k . By definition *quaternionic homology* of C is

$$HQ_n^\zeta(C) := H_n(\text{Tot } QC_{**}^\zeta).$$

When $C = C(A)$, where A is an involutive k -algebra, we denote $HQ^\zeta(C(A))$ by $HQ^\zeta(A)$. If $\zeta = 1$ we simply write $HQ(A)$, and if $\zeta = -1$ we simply write $HQ'(A)$.

5.2.14 Connes Exact Sequence for Quaternionic Homology. Let us denote by TC_{**}^ζ the double complex formed by the first *four* columns of QC_{**}^ζ . By HT_*^ζ we denote the homology of the associated total complex.

These groups fit into a long exact sequence:

$$\dots \rightarrow HT_n^\zeta \rightarrow HQ_n^\zeta \rightarrow HQ_{n-4}^\zeta \rightarrow HT_{n-1}^\zeta \rightarrow HQ_{n-1}^\zeta \rightarrow \dots$$

and they are related to Hochschild homology (when $\zeta = 1$ and $1/2 \in k$) by the following exact sequence

$$\dots \rightarrow HH_n^- \rightarrow HT_n \rightarrow HH_{n-2}^+ \rightarrow HT_{n-1} \rightarrow HH_{n-1}^- \rightarrow \dots$$

When $A = k$, then $HT_n^\zeta(k) = 0$ for $n \geq 3$ and so $HQ_n^\zeta(k)$ is periodic of period 4. For any $n \geq 0$ one has

$$\begin{aligned} HT_0(k) = HQ_{4n}(k) = k/2k, & & HT'_0(k) = HQ'_{4n}(k) = k, \\ HT_1(k) = HQ_{4n+1}(k) = {}_2k & & HT'_1(k) = HQ'_{4n+1}(k) = k/2k, \\ HT_2(k) = HQ_{4n+2}(k) = k, & & HT'_2(k) = HQ'_{4n+2}(k) = {}_2k, \\ HT_3(k) = HQ_{4n+3}(k) = 0, & & HT'_3(k) = HQ'_{4n+3}(k) = 0, \end{aligned}$$

where ${}_2k$ is the 2-torsion of k .

5.2.15 Proposition. *If 2 is invertible in k and A is an involutive k -algebra, then there are canonical isomorphisms $HQ_n(A) \cong HD_n(A)$ and $HQ'_n(A) \cong HD'_n(A)$. \square*

Remark that when $1/2 \in k$ the periodicity operator $HQ_n \rightarrow HQ_{n-4}$ can be identified with the composite $HD_n \rightarrow HD'_{n-2} \rightarrow HD_{n-4}$.

Exercises

E.5.2.1. Universal Exercise. Take any result in this book about cyclic homology and try to find and prove an analog for quaternionic or dihedral homology.

E.5.2.2. Prove that $HH_*(A) \cong HH_*(A^{\text{op}})$, where A^{op} is the opposite algebra (and similarly for HC). (Mimick Lemma 5.2.6.)

E.5.2.3. Show that for any 4th root of unity ζ one has the following computations:

$$\begin{aligned} HT_0^\zeta(k) &= HQ_{4n}^\zeta(k) = k/\text{Im}(1 + \zeta), \\ HT_1^\zeta(k) &= HQ_{4n+1}^\zeta(k) = \text{Ker}(1 + \zeta)/\text{Im}(1 - \zeta), \\ HT_2^\zeta(k) &= HQ_{4n+2}^\zeta(k) = \text{Ker}(1 - \zeta), \\ HT_3^\zeta(k) &= HQ_{4n+3}^\zeta(k) = 0. \end{aligned}$$

E.5.2.4. Dihedral Homology Without the Assumption 2 Invertible.

Show that the total complex associated to the following bicomplex is a resolution of the trivial D_n -module k .

$$\begin{array}{ccccccc} & \downarrow & & \downarrow & & \downarrow & & \downarrow \\ k[D_n] & \xleftarrow{1-\tau} & k[D_n] & \xleftarrow{N} & k[D_n] & \xleftarrow{1-\tau} & k[D_n] & \leftarrow \\ 1+\tau \downarrow & & \omega\tau-1 \downarrow & & 1-\tau \downarrow & & -\omega\tau-1 \downarrow & \\ k[D_n] & \xleftarrow{1-\tau} & k[D_n] & \xleftarrow{N} & k[D_n] & \xleftarrow{1-\tau} & k[D_n] & \leftarrow \\ 1-\tau \downarrow & & -\omega\tau-1 \downarrow & & 1+\tau \downarrow & & \omega\tau-1 \downarrow & \\ k[D_n] & \xleftarrow{1-\tau} & k[D_n] & \xleftarrow{N} & k[D_n] & \xleftarrow{1-\tau} & k[D_n] & \leftarrow \end{array}$$

Use this bicomplex and Hochschild complex to define a tricomplex whose homology is a definition for $HD(A)$ which is valid without supposing that 2 is invertible, and which coincides with our definition when 2 is invertible (cf. Lodder [1990]).

E.5.2.5. Define cohomological functors HD^* and HQ^* by mimicking Sect. 2.4.

E.5.2.6. Equip $A \otimes A^{\text{op}}$ with the involution $(a, b) \mapsto (b, a)$. Compute $HD_*(A \otimes A^{\text{op}})$.

5.3 Differential Graded Algebras

All the theories considered so far can be extended to the category of graded algebras and more generally to the category of differential graded algebras. The differential of the algebra brings in some complication, but it gives some more freedom since one can replace a DG -algebra by an equivalent one in order to compute its homology. In particular one can replace any algebra by a DG -algebra whose underlying algebra is a tensor algebra. In a certain sense this procedure is equivalent to choosing another resolution to compute Hochschild homology. It has the advantage of working as well in cyclic homology. This generalization has been done by Burghel-Vigué [1988] and Goodwillie [1985a] independently.

5.3.1 Definitions. A *Differential Graded k -Algebra*, *DG-algebra* for short (also called *chain algebra*), is a non-negatively graded associative algebra $A = \bigoplus_{n \geq 0} A_n$ (that is $A_p \cdot A_q \subset A_{p+q}$) with unit $1 \in A_0$, endowed with a degree -1 differential $\delta : A_n \rightarrow A_{n-1}$ (that is $\delta^2 = 0$) which is a graded derivation for the product in A

$$\delta(ab) = \delta a \cdot b + (-1)^{|a|} a \cdot \delta b .$$

An element $a \in A_i$ is said to be *homogeneous* of degree $i = |a|$. An ordinary algebra is considered as a particular case of a *DG-algebra* concentrated in degree 0 ($A = A_0, \delta = 0$).

If $A = T(V)$, the tensor algebra of a positively graded free k -module V , then $(T(V), \delta)$ is called a *tensor DG-algebra*.

Any *DG-algebra* (A, δ) gives rise to a complex

$$\dots \rightarrow A_n \xrightarrow{\delta} A_{n-1} \rightarrow \dots \rightarrow A_0$$

still denoted (A, δ) , whose homology is denoted $H_*(A, \delta)$ and is simply called the *homology of the DG-algebra* (A, δ) .

The iterated tensor product of complexes $(A, \delta)^{\otimes n+1}$ is a complex whose underlying module is the graded module $A^{\otimes n+1}$ and whose differential is still denoted δ (cf. 1.0.14). It is useful to introduce the following notions for a homogeneous element $x = (a_0, \dots, a_n)$ of $A^{\otimes n+1}$:

- (a) the *length* of x is $l(x) = n$,
- (b) the *weight* (or degree if no confusion can arise) of x is $w(x) = |a_0| + |a_1| + \dots + |a_n|$,
- (c) the *total degree* of x is $|x| = l(x) + w(x)$.

5.3.2 Hochschild Homology of DG-Algebras. For any *DG-algebra* (A, δ) the functor $[n] \mapsto (A, \delta)^{\otimes n+1}$ defines a cyclic chain complex, i.e. a cyclic object $C(A, \delta)$ in the (abelian) category of complexes over k (cf. 2.5.3).

Explicitly the faces, the degeneracies and the cyclic operator are described as follows (the elements a_i are all supposed to be homogeneous):

$$d_i(a_0, \dots, a_n) = (a_0, \dots, a_i a_{i+1}, \dots, a_n) , \quad 0 \leq i < n ,$$

$$d_n(a_0, \dots, a_n) = \pm(a_n a_0, a_1, \dots, a_{n-1})$$

[here we use the Koszul-Quillen sign convention, cf. 1.0.15, more precisely the sign is (-1) to the power $|a_n|(|a_0| + |a_1| + \dots + |a_{n-1}|)$].

$$s_i(a_0, \dots, a_n) = (a_0, \dots, a_i, 1, a_{i+1}, \dots, a_n) ,$$

$$t_n(a_0, \dots, a_n) = \pm(-1)^n(a_n, a_0, \dots, a_{n-1}) \quad (\text{same sign } \pm \text{ as before}) .$$

The Hochschild complex associated to $C(A, \delta)$ is a complex of complexes (since $A^{\otimes n+1}$ is replaced by $(A, \delta)^{\otimes n+1}$) with boundary map $b = \sum_{i=0}^n (-1)^i d_i : C(A, \delta)^{\otimes n+1} \rightarrow C(A, \delta)^{\otimes n}$. A straightforward checking shows

that b commutes with the boundary map $\delta : A^{\otimes n+1} \rightarrow A^{\otimes n+1}$ of the complex $C(A, \delta)^{\otimes n+1}$. In order to make it into a bicomplex we multiply this boundary map by $(-1)^n$. Explicitly this bicomplex is

$$(5.3.2.1) \quad \begin{array}{ccccccc} & & \downarrow & & \downarrow & & \downarrow \\ & & (A^{\otimes 3})_0 & \xleftarrow{\delta} & (A^{\otimes 3})_1 & \xleftarrow{\delta} & (A^{\otimes 3})_2 & \xleftarrow{\delta} \\ & & b \downarrow & & b \downarrow & & b \downarrow & \\ & & (A^{\otimes 2})_0 & \xleftarrow{-\delta} & (A^{\otimes 2})_1 & \xleftarrow{-\delta} & (A^{\otimes 2})_2 & \xleftarrow{-\delta} \\ & & b \downarrow & & b \downarrow & & b \downarrow & \\ & & A_0 & \xleftarrow{\delta} & A_1 & \xleftarrow{\delta} & A_2 & \xleftarrow{\delta} \end{array}$$

where $(A^{\otimes n+1})_p$ denotes the (weight p)-part of the tensor product, that is

$$(A^{\otimes n+1})_p = \bigoplus_{i_0+\dots+i_n=p} A_{i_0} \otimes \dots \otimes A_{i_n} .$$

Note that the horizontal map δ (of weight -1) is given by the formula

$$\delta(a_0, \dots, a_n) = \sum_{i=0}^n \pm(a_0, \dots, a_{i-1}, \delta a_i, a_{i+1}, \dots, a_n) .$$

By definition the *Hochschild complex* $C_*(A, \delta)$ (or simply $C(A, \delta)$) of the *DG-algebra* (A, δ) is the total complex (with boundary $b \pm \delta$) of the bicomplex (5.3.2.1). Its homology is denoted by $HH_*(A, \delta)$ [not to be confused with $H_*(A, \delta)$ defined in 5.3.1, see 5.4.8.1].

The *reduced Hochschild complex* $\overline{C}(A, \delta)$ is defined analogously by replacing $A^{\otimes n+1}$ by $A \otimes \overline{A}^{\otimes n}$ throughout, $\overline{A} = A/k$.

5.3.3 Cyclic Homology of DG-Algebras. Since $C(A, \delta)$ is a cyclic complex, there is defined a boundary map $B = (1-t)sN : A^{\otimes n} \rightarrow A^{\otimes n+1}$, where the cyclic operator t is as defined in 5.3.2. Therefore there is a tri-complex $\mathcal{BC}(A, \delta)$ such that $(\mathcal{BC}(A, \delta))_{pqr} = (A^{\otimes q-r+1})_p$, with differentials $\pm\delta, b$ and B .

By definition *cyclic homology of the DG-algebra* (A, δ) is

$$HC_*(A, \delta) := H_*(\text{Tot}(\mathcal{BC}(A, \delta))) .$$

[For a tricomplex C , one has $(\text{Tot } C)_n = \bigoplus_{p+q+r=n} C_{pqr}$]. There is of course a normalized version $\overline{\mathcal{BC}}(A, \delta)$ which consists in replacing $A^{\otimes n+1}$ by $A \otimes \overline{A}^{\otimes n}$. As in the non-graded case there is a natural isomorphism

$$HC_*(A, \delta) \cong H_*(\text{Tot } \overline{\mathcal{BC}}(A, \delta)) .$$

Most of the results of Chaps. 1 to 4 can be extended to DG -algebras (since it consists essentially in applying them to cyclic objects in an abelian category), namely Connes periodicity exact sequence, Morita invariance, operations, existence of the other theories $HC_*^-(A, \delta)$, $HC_*^{\text{per}}(A, \delta)$ and $HD_*(A, \delta)$. The details are left to the reader.

5.3.4 Filtration and Spectral Sequences. Since $HH_*(A, \delta)$ is the homology of a bicomplex (cf. 5.3.2.1), it is the abutment of two spectral sequences which can be used for computation. In particular there is a natural filtration which is induced by the weight. The same comment is valid for $HC_*(A, \delta)$. However, most of the time it is more efficient to work directly with the tri-complex by replacing the columns by quasi-isomorphic complexes, the resulting tri-complex being (for good choices) easier to compute. This is the method we are going to use in the sequel.

Note that if $\delta = 0$, then HH and HC of $(A, 0)$ are *not* equal a priori to HH and HC of A since the last face d_n is not the same in the two cases. However if A is concentrated in degree 0, then both theories agree.

When a map of DG -algebras $f : (A, \delta) \rightarrow (A', \delta)$ induces an isomorphism in homology it is called an *equivalence* of DG -algebras. The importance of this notion is clearly seen in the next result.

5.3.5 Theorem. *Let $f : (A, \delta) \rightarrow (A', \delta)$ be an equivalence of DG -algebras. If A and A' are flat over k , then f induces an isomorphism on HH_* , HC_* , HC_*^{per} and HC_*^- .*

Proof. Let us prove the Hochschild case first. The flatness hypothesis implies that $f : (A, \delta)^{\otimes n} \rightarrow (A', \delta)^{\otimes n}$ is a quasi-isomorphism (Künneth formula). The comparison theorem for the associated bicomplexes $C(A, \delta)$ and $C(A', \delta)$ (cf. 1.0.12) shows that $HH_*(A, \delta) \cong HH_*(A', \delta)$.

A similar argument (cf. 2.2.3) permits us to extend this isomorphism to HC_* and also to HC_*^{per} and HC_*^- (cf. 5.1.6). \square

The interest of this generalization to DG -algebras lies in the following result.

5.3.6 Proposition-Definition. *For any unital DG -algebra (A, δ) over k there exists a graded free module V and a tensor DG -algebra $(T(V), \delta)$ which is equivalent to (A, δ) . This is called a “free model” of the DG -algebra (A, δ) .*

Proof. By induction on n one constructs a family of free k -modules V_n and a family of DG -algebra maps $\xi_n : (T(V_n), \delta) \rightarrow (A, \delta)$ which are n -connected, that is, which induce an isomorphism on H_i for $i < n$ and a surjection on H_n .

For $n = -1$ one takes $V_{-1} = 0$ and $\delta = 0$ on $T(0) = k$. So ξ_{-1} is the unit map $k \rightarrow A$. Given $(T(V_{n-1}), \delta)$ one constructs $(T(V_n), \delta)$ as follows. For each

pair (w, a) , $w \in T(V_{n-1})$, $a \in A_n$ such that $\xi_{n-1}(w) = \delta a$ and $\delta w = 0$, one adjoins an element denoted (w, a) to V_{n-1} in order to get V_n . Extend ξ_{n-1} to a graded algebra map ξ_n by setting $\xi_n(w, a) = a$ and extend the differential by setting $\delta(w, a) = w$ and requiring that δ is a graded derivation.

By construction the map ξ_n is n -connected. Put $V = \cup_{n \geq -1} V_n$, then there is defined a map $\xi : (T(V), \delta) \rightarrow (A, \delta)$ which is a quasi-isomorphism, i.e. an equivalence of DG -algebras. \square

5.3.7 HH and HC of Free Models. By using the small complex devised in Sect. 3.1 to compute HH and HC of a tensor algebra, one can construct new complexes to compute HH and HC of a free model.

Let $V = V_0 \oplus V_1 \oplus \dots$ be a graded free k -module and let $(A, \delta) = (T(V), \delta)$ be a tensor DG -algebra. One denotes by $(A \otimes V)_n$ the subspace of elements of weight n in $A \otimes V$. There is defined a map $\phi : A \otimes A \rightarrow A \otimes V$ by

$$\phi(a \otimes v_1 \dots v_n) = \sum_{i=1}^n \pm v_{i+1} \dots v_n a v_1 \dots v_{i-1} \otimes v_i$$

and a map $b : A \otimes V \rightarrow A$ by $b(a \otimes v) = [a, v]$.

As usual we put $V_+ = k \oplus V$.

5.3.8 Proposition. *Hochschild homology of the DG-algebra $(A, \delta) = (T(V), \delta)$ is the homology of the complex*

$$(A \otimes V_+, \tilde{b}) : \dots \rightarrow A_n \oplus (A \otimes V)_{n-1} \xrightarrow{\tilde{b}} A_{n-1} \oplus (A \otimes V)_{n-2} \rightarrow \dots \rightarrow A_0$$

where $\tilde{b} = \begin{bmatrix} \delta & b \\ 0 & \tilde{\delta} \end{bmatrix}$ is given by

$$b(a \otimes v) = [a, v] \quad \text{and} \quad \tilde{\delta}(a \otimes v) = \delta a \otimes v + (-1)^{|a|} a \otimes \delta v.$$

Proof. Consider the following bicomplex with only two rows (in degree 0 and 1)

$$(5.3.8.1) \quad \begin{array}{ccccc} (A \otimes V)_0 & \xleftarrow{\tilde{\delta}} & (A \otimes V)_1 & \leftarrow & \dots \\ b \downarrow & & b \downarrow & & \\ A_0 & \xleftarrow{\delta} & A_1 & \leftarrow & \dots \end{array}$$

There is a map of bicomplexes $\tilde{\phi}$ from $\overline{C}(T(V), \delta)$ to the small bicomplex (5.3.8.1) which is the identity on the first row, which is ϕ on the next row and which is zero on the others (no choice!). The verifications are straightforward. By the same argument as in Sect. 3.1, it can be proved that this map is a quasi-isomorphism on columns and so is a quasi-isomorphism of bicomplexes.

Then it suffices to remark that the complex $(A \otimes V_+, \tilde{b})$ is the total complex of (5.3.8.1). \square

In order to get a new complex for computing cyclic homology it is sufficient to construct the analog of Connes boundary map B on the complex $(A \otimes V_+, b)$. It is easier to state this result in terms of mixed complexes (cf. 2.5.12).

5.3.9 Proposition. *Let $(A, \delta) = (T(V), \delta)$ be a tensor DG-algebra with V free over k . Then the map*

$$\tilde{B} = \begin{bmatrix} 0 & 0 \\ \gamma & 0 \end{bmatrix} : A_n \oplus (A \otimes V)_{n-1} \rightarrow A_{n+1} \oplus (A \otimes V)_n ,$$

where $\gamma(a) = \phi(1, a)$, that is

$$\gamma(v_1 \dots v_n) = \sum_{i=1}^n \pm v_{i+1} \dots v_n v_1 \dots v_{i-1} \otimes v_i ,$$

endows $(A \otimes V_+, \tilde{b})$ with a structure of mixed complex. Cyclic homology of the mixed complex $(A \otimes V_+, \tilde{b}, \tilde{B})$ is canonically isomorphic to $HC_*(T(V), \delta)$.

Proof. First, one needs to verify that $\tilde{b}\tilde{B} + \tilde{B}\tilde{b} = 0$, which is equivalent to

$$\begin{cases} b\gamma = \gamma b = 0 & (\text{cf. 3.1.5}), \\ \delta\gamma + \gamma\delta = 0. \end{cases}$$

The last equality follows from the equalities $\phi(a, v) = (a, v)$ and $\phi(a, xy) = \phi(ax, y) \pm \phi(ya, x)$, $a, x, y \in A = T(V)$ and $v \in V$, which determine ϕ completely.

Secondly, one needs to verify that $\tilde{\phi}B = \tilde{B}\tilde{\phi}$, that is $\phi \circ B = \gamma$. This is immediate from the definition of γ . \square

These complexes permit us to compute HH_* and HC_* of $(T(V), 0)$, generalizing the non-graded case (cf. Sect. 3.1). Recall that $(V^{\otimes m})_\tau = V^{\otimes m}/(1-\tau)$ denotes the space of coinvariants for the action of the cyclic operator τ , and $(V^{\otimes m})^\tau = \text{Ker}(1-\tau)$ denotes the space of invariants for the action of τ .

5.3.10 Proposition. *Let V be a free non-negatively graded module over k . There are isomorphisms of graded modules:*

$$HH_*(T(V), 0) \cong \oplus_{m \geq 0} (V^{\otimes m})_\tau \oplus \oplus_{m > 0} (V^{\otimes m})^\tau[1] ,$$

$$HC_n(T(V), 0) \cong HC_n(k) \oplus \oplus_{m > 0} (\oplus_{p+q=n} H_p(\mathbb{Z}/m\mathbb{Z}, (V^{\otimes m})_q)) .$$

The map S on HC_n is, when restricted to $H_p(\mathbb{Z}/m\mathbb{Z}, (V^{\otimes m})_q)$, the periodicity isomorphism $H_p \cong H_{p-2}$ for $p > 2$, an inclusion $H_2 \hookrightarrow H_0$ for $p = 2$, and 0 for $p = 1$ and 0.

Proof. The hypothesis $\delta = 0$ implies $\tilde{\delta} = 0$ and so by Proposition 5.3.8 we have $HH_n(T(V), 0) = \text{Coker}(b : (A \otimes V)_n \rightarrow A_n) \oplus \text{Ker}(b : (A \otimes V)_{n-1} \rightarrow A_{n-1})$. On $V^{\otimes m-1} \otimes V = V^{\otimes m}$ the map b is just $1 - \tau$ whose cokernel is $(V^{\otimes m})_\tau$ and whose kernel is $(V^{\otimes m})^\tau$. This gives the computation of Hochschild homology.

For cyclic homology it is clear that $HC_*(T(V), 0)$ splits as a sum over $m \geq 0$ of some graded modules. By Proposition 5.3.9 this graded module is, for fixed m , the homology of the complex

$$\dots \rightarrow V^{\otimes m-1} \otimes V \xrightarrow{b} V^{\otimes m-1} \xrightarrow{\gamma} V^{\otimes m-1} \otimes V \rightarrow \dots$$

The piece which lies in HC_n is of total degree $n = p + q$, where p is the length and q the weight. The result follows then from $b = 1 - \tau$ and $\gamma = 1 + \tau + \tau^2 + \dots + \tau^{m-1}$. \square

5.3.11 Derivations on DG-Algebras. A derivation D on (A, δ) is a degree 0 derivation of A which commutes with δ . It is straightforward to extend D to the Hochschild complex $C(A, \delta)$ and to the complex $\mathcal{BC}(A, \delta)$ as in Sect. 4.1 since the relation $[D, \delta] = 0$ on A is also valid on $A^{\otimes n}$. So there are well-defined maps L_D on $HH_*(A, \delta)$ and $HC_*(A, \delta)$.

The proof of Theorem 4.1.10 can be carried out in the DG-case mutatis mutandis to give the following

5.3.12 Proposition. *Let A be a graded algebra over k containing \mathbb{Q} and let*

$$\overline{HH}_*(A, 0) = HH_*(A, 0) / HH_*(A_0),$$

resp. $\overline{HC}_(A, 0) = HC_*(A, 0) / HC_*(A_0)$. Then Connes' exact sequence for \overline{HC} splits into short exact sequences*

$$0 \rightarrow \overline{HC}_{n-1}(A) \rightarrow \overline{HH}_n(A) \rightarrow \overline{HC}_n(A) \rightarrow 0.$$

Proof. Define $D(a) = pa$ for $a \in A_p$. This is a derivation of degree 0 of the DG-algebra $(A, 0)$. Let $F^p = F^p HC_*(A, 0)$ be the filtration of $HC_*(A, 0)$ by the weight. The operator L_D is acting on F^p / F^{p-1} by multiplication by p and so is an isomorphism provided $p \neq 0$. From the graded version of Theorem 4.1.10 it follows that $S = 0$ on $\overline{HC}_*(A)$. \square

5.3.13 Theorem. *Let (A, δ) be a DG-algebra which is $(r + 1)$ -connected (that is $H_0(A, \delta) = k$, $H_i(A, \delta) = 0$ for $1 \leq i \leq r + 1$). Then the map $p!S^p : \overline{HC}_{n+2p}(A, \delta) \rightarrow \overline{HC}_n(A, \delta)$ is 0 for $n < rp$.*

Proof. By refining Proposition 5.3.6 one can check that, when (A, δ) is $(r + 1)$ -connected, one can choose a model $(T(V), \delta)$ such that $V_0 = V_1 = \dots = V_r = 0$. One uses this model to compute $p!S^p$.

Let $\mathcal{BC}(T(V), \delta) = F^0 \supset F^1 \supset \dots \supset F^p \supset F^{p+1} \supset \dots$ be the filtration of $\mathcal{BC}(T(V), \delta)$ by the weight. The generalization of Theorem 4.1.10 to the graded case shows that pS is 0 on $\overline{HC}_*(F^p/F^{p+1})$ and then $p!S^p$ is 0 on $\overline{HC}_*(F^1/F^{p+1})$. The hypothesis on V implies that $HC_*(F^1) \rightarrow HC_*(F^1/F^{p+1})$ is injective for $*$ sufficiently small, whence the result. \square

5.3.14 Corollary (cf. Goodwillie [1985a]). *Let (A, δ) be a DG-algebra over a field k of characteristic 0. For any chain ideal I (i.e. $\delta I \subset I$) of A such that $I_0 = 0$ the quotient map $A \rightarrow A/I$ induces an isomorphism*

$$HC_*^{\text{per}}(A, \delta) \cong HC_*^{\text{per}}(A/I, \delta). \quad \square$$

Exercises

E.5.3.1. Let (A, δ) be a non-unital DG-algebra. Show that there exists a tricomplex $CC(A, \delta)$ similar to the cyclic bicomplex, which permits us to define $HC_*(A, \delta)$.

E.5.3.2. Extend the definition of HH, HC , etc, to the category of simplicial algebras (cf. Goodwillie [1985a, 1985b]).

5.4 Commutative Differential Graded Algebras

In the previous section we have seen how the generalization to DG-algebras can help to find new complexes to simplify the computation of Hochschild and cyclic homology. In the commutative case this can be further simplified since in characteristic zero any commutative algebra is equivalent to a CDG-algebra whose underlying CG-algebra is a graded symmetric algebra (essentially polynomial). This permits us for instance to give another interpretation of the λ -decomposition of both HH and HC . We finish this section by working out explicitly the computation of HH and HC of the truncated polynomial algebra $k[x]/x^{r+1}$ with its λ -decomposition and its weight decomposition. The study of HC of commutative CDG-algebra was performed in Burghelea-Vigué [1988] and in Goodwillie [1985a]. The computation of $HC_*(k[x]/x^{r+1})$ appeared in Bach [1992].

5.4.1 Commutative DG-Algebras. If $ab = (-1)^{|a||b|}ba$ for any homogeneous elements a and b of the DG-algebra (A, δ) , then (A, δ) is said to be *commutative* (CDG-algebra). For instance let $V = \bigoplus_{n \geq 0} V_n$ be a graded k -module and let $A = \Lambda V$ be the *graded symmetric algebra* over V . Explicitly $\Lambda V = S(\bigoplus_{n \geq 0} V_{2n}) \otimes E(\bigoplus_{n \geq 0} V_{2n+1})$ where S is for symmetric algebra functor and E for exterior algebra functor (cf. Appendix A). A CDG-algebra of the form $(\Lambda V, \delta)$ is called a *free CDG-algebra* (though it is *not* a free object in the category of CDG-algebras).

Mimicking the proof of 5.3.6 one can show that in characteristic zero any *CDG*-algebra (A, δ) is equivalent to a free *CDG*-algebra $(\Lambda V, \delta)$. This is called a *free model* of (A, δ) . Moreover, one can take δ such that $\delta V \subset \Lambda^+ V \cdot \Lambda^+ V$, where $\Lambda^+ V$ is the ideal of ΛV generated by the elements of V . Such an equivalence $(\Lambda V, \delta) \rightarrow (A, \delta)$ is called a *minimal model* for (A, δ) .

5.4.2 The Graded Module $\Omega_{A|k}^1$. When A is non-negatively graded (according to 5.3.1 we should say *weighted*) and graded commutative, one can still define a graded A -module $\Omega_{A|k}^1$ as follows. The graded A -bimodule $A \otimes A$ is also a graded algebra for the product $(a \otimes b)(x \otimes y) = (-1)^{|b||x|} ax \otimes by$ for homogeneous elements $a, b, x, y \in A$. Then I is a graded A -bimodule and I/I^2 is a graded symmetric A -bimodule. By definition we put $\Omega_{A|k}^1 = I/I^2$. As in the non-graded case $\Omega_{A|k}^1$ is generated as a graded A -module by the elements $da, a \in A$ (with $|da| = |a|$ for a homogeneous) subject to the relations

$$(5.4.2.1) \quad d(ab) = adb + (da)b = adb + (-1)^{|a||b|} bda .$$

(This means that d has weight 0.) The element adb corresponds to $a(1 \otimes b - b \otimes 1) = a \otimes b - ab \otimes 1$ in I/I^2 . Its weight is $|a| + |b|$.

5.4.3 Graded Exterior Differential Module for *CDG*-Algebras. For a graded A -module M the *graded exterior product* of M with itself over A is $M \overline{\wedge}_A M = M \otimes_A M / \sim$ where the equivalence relation \sim is generated by

$$(5.4.3.0) \quad m \otimes n \sim -(-1)^{|m||n|} n \otimes m , \quad n, m \text{ homogeneous} .$$

More generally $\overline{\wedge}_A^n M = M^{\otimes n} / \approx$, where the equivalence relation is generated by (5.4.3.0). Remark that the sign coming in a reordering of $m_1 \overline{\wedge} \dots \overline{\wedge} m_n$ is the sign of the permutation times the Koszul sign (cf. 1.0.15). If M is concentrated in degree 0 (resp. 1) it coincides with the usual exterior product (resp. symmetric product). In other words there is an isomorphism of k -modules, $M \overline{\wedge} M \cong M[1] \wedge M[1]$.

By definition the *graded exterior differential module* of the *CG*-algebra A is

$$\Omega_{A|k}^n = \overline{\wedge}_A^n \Omega_{A|k}^1 .$$

For $x \in \Omega_{A|k}^n$, the integer n is the *length* of x . Remark that

$$(5.4.3.1) \quad dx dy = -(-1)^{|x||y|} dy dx .$$

There is an obvious extension of the differential map δ to $\Omega_{A|k}^n$ which decreases the weight by 1. It is given by

$$(5.4.3.2) \quad \delta(a_0 da_1 \dots da_n) := (-1)^n \left(\delta a_0 da_1 \dots da_n + (-1)^{|a_0|} a_0 d(\delta a_1) da_2 \dots da_n + \dots \right. \\ \left. \dots + (-1)^{|a_0| + \dots + |a_{n-1}|} a_0 da_1 \dots d(\delta a_n) \right) .$$

characteristic zero any *CDG*-algebra is equivalent to some free *CDG*-algebra (AV, δ) . Note that as an ordinary algebra AV is not smooth in general. For instance if $V = V_1 = k$ then $AV = k[x]/x^2$.

The main point about graded smooth algebras is the generalization of the Hochschild-Kostant-Rosenberg theorem:

(5.4.5.1) *for any graded smooth algebra A there is an isomorphism*

$$HH_*(A, 0) \cong \Omega_{(A,0)}^*$$

As in the non-graded case, the free case and the characteristic zero case are easier to handle since then the HKR-isomorphism is induced by a chain map (cf. 3.2.3).

5.4.6 Proposition. *Let (A, δ) be a *CDG*-algebra such that either $A = AV$, or k contains \mathbb{Q} and A is smooth. Then the complex $C(A, \delta)$ is quasi-isomorphic to $\Omega_{(A,\delta)}^*$ and so*

$$HH_*(A, \delta) \cong H_*(\Omega_{(A,\delta)}^*)$$

In particular there is a natural splitting $HH_(A, \delta) \cong \bigoplus_{i \geq 0} H_{*-i}((\Omega_{A|k}^i)_*, \delta)$.*

Proof. In both cases the map ε is a chain map from $C(A, \delta)$ to $\Omega_{(A,\delta)}^*$ which is, by HKR-theorem, an isomorphism when restricted to the columns. So, by the standard argument, it is an isomorphism on the total complexes. \square

To compute cyclic homology of (A, δ) when A is smooth it suffices to know what the Connes boundary map B induces on $\Omega_{(A,\delta)}^*$. The answer is the differential of forms d (not to be confused with δ) as it was proved in 2.3.3 for the non-graded case. The proof of the graded case is the same mutatis mutandis. Since this differential anti-commutes with δ it endows $\Omega_{(A,\delta)}^*$ with a structure of mixed complex (cf. Sect. 2.5) denoted $(\Omega_{A|k}^*, \delta, d)$. Since $\Omega_{(A,\delta)}^*$ is the direct sum of its rows (suitably shifted) the bicomplex associated to $(\Omega_{A|k}^*, \delta, d)$ is the sum over i of the following bicomplexes, where Ω_p^q stands for $(\Omega_{A|k}^q)_p$,

$$\begin{array}{ccccccc}
 (\Omega_{*-i}^{i-*}, \delta, d) : & \dots & & \dots & & \dots & & \dots \\
 & \downarrow & & \downarrow & & \downarrow & & \downarrow \\
 & \Omega_1^i & \leftarrow & \Omega_1^{i-1} & \leftarrow & \Omega_1^{i-2} & \leftarrow \dots \leftarrow & \Omega_1^0 \\
 & \downarrow & & \downarrow & & \downarrow & & \downarrow \\
 & \Omega_0^i & \leftarrow & \Omega_0^{i-1} & \leftarrow & \Omega_0^{i-2} & \leftarrow \dots \leftarrow & \Omega_0^0 \\
 & \downarrow & & \downarrow & & \downarrow & & \downarrow \\
 & 0 & & 0 & & 0 & \dots & 0
 \end{array}$$

in which Ω_0^i is in bidegree $(0, i)$.

5.4.7 Theorem. *Let (A, δ) be a CDG-algebra such that either $A = \Lambda V$, or k contains \mathbb{Q} and A is smooth. Then $HC_*(A, \delta)$ is canonically isomorphic to the cyclic homology of the mixed complex $(\Omega_{A|k}^*, \delta, d)$, denoted $HC_*(\Omega_{A|k}^*, \delta, d)$. More precisely*

$$HC_*(A, \delta) = \bigoplus_{i \geq 0} H_* \left(\text{Tot} (\Omega_{*-i}^{i-*}, \delta, d) \right) . \quad \square$$

5.4.8 λ -Decomposition for HH and HC of a CDG-Algebra. In this subsection we use freely the notation of Sect. 4.5, namely the Eulerian idempotents $e_n^{(i)}$ of $k[S_n]$. Let (A, δ) be a CDG-algebra. Any permutation $\sigma \in S_n$ acts on $A^{\otimes n}$ by

$$\sigma(a_0, \dots, a_n) = \pm (a_{\sigma^{-1}(1)}, \dots, a_{\sigma^{-1}(n)}) .$$

Hence $k[S_n]$ acts on the n th row of the bicomplex (5.3.2.1) (whose total complex is $C(A, \delta)$). When k contains \mathbb{Q} the idempotents $e_n^{(i)}$ permit us to split this bicomplex into a sum of bicomplexes $C^{(i)}(A, \delta)$ and so

$$HH_*(A, \delta) = \bigoplus_{i \geq 0} HH_*^{(i)}(A, \delta) .$$

In particular we get

$$(5.4.8.1) \quad HH_*^{(0)}(A, \delta) = H_*(A, \delta) .$$

It almost behaves as in the non-graded case. However one should remark that in the graded case there is no reason for $HH_n^{(i)}(A, \delta)$ to be 0 when $i > n$.

Similarly there is a λ -decomposition of cyclic homology for any CDG-algebra (A, δ) ,

$$HC_*(A, \delta) = \bigoplus_{i \geq 0} HC_*^{(i)}(A, \delta) .$$

Suppose now that A is smooth, for instance $A = \Lambda V$. We already noted in 5.4.6 and 5.4.7 that $HH_*(A, \delta)$ and $HC_*(A, \delta)$ are naturally split. This splitting corresponds in fact to the λ -decomposition as shown by the following

5.4.9 Proposition. *If k contains \mathbb{Q} and (A, δ) is a smooth CDG-algebra, then the λ -decomposition and the decomposition coming from the graded structure agree both in Hochschild and in cyclic homology.*

Proof. The map $C(A, \delta) \rightarrow \Omega_{A|k}^*$ restricted to $A^{\otimes n+1}$ is the composite of the projection onto the image of $e_n^{(n)}$ (which is $A \otimes \overline{\Lambda}^n A$) and the map $a_0 \otimes (a_1 \wedge \dots \wedge a_n) \mapsto a_0 da_1 \dots da_n$. Therefore the i th piece of $C(A, \delta)$ is quasi-isomorphic to $(\Omega_{A|k}^i, \delta)$. Whence the result. \square

5.4.10 Remark. Any *CDG*-algebra (A, δ) has a free (hence smooth) model $(\Lambda V, \delta)$. In particular, if A is an ordinary algebra, then $(A, 0)$ has a free model from which one can define a decomposition of $HH_*(A)$ and of $HC_*(A)$. Proposition 5.4.9 shows that this decomposition does not depend on the model.

5.4.11 The Free *CDG*-Algebra Case. Let $A = \Lambda V$, where V is a graded free module over k . A generalization of the non-graded case (cf. 1.3.6) shows that $\Omega_{A|k}^1$ is canonically isomorphic as a graded ΛV -module to $\Lambda V \otimes V$ and more generally $\Omega_{A|k}^n$ is canonically isomorphic to $\Lambda V \otimes \bar{\Lambda}^n V = \Lambda V \otimes \Lambda^n(V[1])$. Note that the total degree of $a \otimes (v_1, \dots, v_n)$ is $|a| + |v_1| + \dots + |v_n| + n$.

The complex which computes $HC(A, \delta)$ can be simplified accordingly because the de Rham complex of ΛV is acyclic. So, if we factor out the bicomplex $(\Omega_{*-i}^{i-*}, \delta, d)$ by $\Omega_0^0 = k$, then it is quasi-isomorphic to a bicomplex with one non-trivial column. This column, which is in degree $p = 0$, consists of the modules $\Omega_{q-i}^i/d\Omega_{q-i}^{i-1}$ (in bidegree $(0, q)$). So we have proved the following

5.4.12 Theorem. *Suppose that k contains \mathbb{Q} and let $(\Lambda V, \delta)$ be a free *CDG*-algebra. Then there is a canonical isomorphism*

$$HC_n(A, \delta) \cong HC_n(k) \oplus_{q \geq 0} H_{n-q} \left(\left(\Omega_{\Lambda V|k}^q/d\Omega_{\Lambda V|k}^{q-1} \right)_*, \delta \right). \quad \square$$

5.4.13 Remark. In this setting the map S can be described as follows. An element $x \in \Omega_p^q$ defines an element $[x]$ in $\overline{HC}_{q+p}^{(q)}$ if and only if there exists $y \in \Omega_{p-1}^{q-1}$ such that $\delta(x) = d(y)$. Then $S[x] = [y]$.

5.4.14 Application: *HC* of Truncated Polynomial Algebras. Let r be a positive integer and let $k[x]/x^{r+1}$ be the truncated polynomial algebra. One can put a new weight, called the *x-weight*, on this algebra by decreeing that the *x-weight* of x^i is i . Then the Hochschild and cyclic homology groups of $k[x]/x^{r+1}$ split into a direct sum of subgroups according to the *x-weight*. Our aim is to compute $HH_n(k[x]/x^{r+1})$ and $HC_n(k[x]/x^{r+1})$ and to determine their *x-weight* decomposition and their λ -decomposition.

The truncated polynomial algebra $k[x]/x^{r+1}$ admits the free model (A, δ) over $V = kx \oplus ky$ (free k -module of rank 2 generated by x and y), $A = \Lambda(V)$, $\delta(x) = 0$, $\delta(y) = x^{r+1}$, weight $(x) = |x| = 0$ and weight $(y) = |y| = 1$.

If we assign to y the *x-weight* $r + 1$, then the map $(\Lambda V, \delta) \rightarrow (k[x]/x^{r+1}, 0)$, $x \mapsto x$, $y \mapsto 0$, is compatible with the *x-weight*. Note that, as an algebra $A = k[x, y]/(y^2)$.

The ΛV -module $\Omega_{A|k}^*$ is generated over A by dx and dy subject to the following relations (cf. 5.4.3.1): $(dx)^2 = 0$, $dx dy = -dy dx$. Thus $\Omega_p^q = 0$, except for $p = q - 1$, q and $q + 1$. As a free k -module

- Ω_{q-1}^q is generated by $x^i dx(dy)^{q-1}$, $i \geq 0$,
- Ω_q^q is generated by $x^i (dy)^q$ and $x^i y dx(dy)^{q-1}$, $i \geq 0$,
- Ω_{q+1}^q is generated by $x^i y (dy)^q$, $i \geq 0$.

Let us put $a(i) := x^i dx(dy)^{q-1}$, $i \geq 0$, $b(i) := x^i (dy)^q - q(r+1)x^{i-1}y dx(dy)^{q-1}$, $i > 0$, and $b(0) := (dy)^q$.

Then

- Ω_{q-1}^q is generated by $a(i)$, $i \geq 0$,
- Ω_q^q is generated by $b(i)$ and $ya(i)$, $i \geq 0$,
- Ω_{q+1}^q is generated by $yb(i)$, $i \geq 0$.

An easy computation shows that

$$\begin{aligned} \delta(yb(i)) &= b(i+r+1), & \delta(b(i)) &= 0 \quad \text{if } i > 0, \\ \delta(b(0)) &= (-1)^q(r+1)a(r), & \delta(ya(i)) &= a(i+r+1), \end{aligned}$$

and of course $\delta(a(i)) = 0$. By Proposition 5.4.6 this proves the following

5.4.15 Proposition. *For any commutative ring k and any integer $r \geq 1$, one has, for $q > 0$,*

$$HH_{2q}(k[x]/x^{r+1}) \cong k^r \oplus_{r+1} k,$$

where the generators of the free part have x -weight $q(r+1)+i$ for $i = 1, \dots, r$ and the torsion part has x -weight $q(r+1)$,

$$HH_{2q-1}(k[x]/x^{r+1}) \cong k^r \oplus k/(r+1)k,$$

where the generators of the free part have x -weight $(q-1)(r+1)+i+1$ for $i = 1, \dots, r$ and the quotient part has x -weight $q(r+1)$.

Moreover, when k contains \mathbb{Q} , one has $HH_{2q} = HH_{2q}^{(q)}$ and $HH_{2q-1} = HH_{2q-1}^{(q)}$.

Proof. (Compare with the method suggested in Exercise E.4.1.8). Indeed the free generators for HH_{2q} are $b(i)$ for $i = 1, \dots, r$ and $b(i)$ is of x -weight $i + q(r+1)$. The free generators of HH_{2q-1} are $a(i)$ for $i = 1, \dots, r$ and $a(i)$ is of x -weight $i + 1 + (q-1)(r+1)$. The other components come from $\delta(b(0)) = (-1)^q(r+1)a(r)$. The assertion about the λ -degree comes from the fact that all these generators are in Ω^q (cf. 5.4.9). \square

A priori one could compute $HC_*(A)$ for $A = k[x]/x^{r+1}$ by working with the bicomplex (Ω_*^*, δ, d) . However there is a simpler way to work it out, by using the comparison of (Ω_*^*, δ) with a small complex. Explicitly let $C^{\text{sm}} = (C^{\text{sm}}(A), \bar{\delta})$ be the periodic complex

$$\dots \rightarrow A \xrightarrow{0} A \xrightarrow{(r+1)x^r} A \xrightarrow{0} A,$$

whose homology is $HH_*(A)$ (cf. Exercise E.4.1.8). It is helpful to look at C^{sm} as a sum of smaller complexes $C^{\text{sm},q}$:

$$\dots \rightarrow 0 \rightarrow 0 \rightarrow C_{2q}^{\text{sm}} \rightarrow C_{2q-1}^{\text{sm}} \rightarrow 0 \rightarrow \dots \rightarrow 0.$$

The quasi-isomorphism $\Omega_{A|k}^* \rightarrow C^{\text{sm}}(A)$ is the direct sum of the maps

$$\begin{array}{ccccc} \Omega_{q-1}^q & \xleftarrow{\delta} & \Omega_q^q & \xleftarrow{\delta} & \Omega_{q+1}^q \\ \downarrow & & \downarrow & & \downarrow \\ C_{2q-1}^{\text{sm}} & \xleftarrow{(r+1)x^r} & C_{2q}^{\text{sm}} & \xleftarrow{\quad} & 0 \end{array}$$

which send $yb(i)$ to 0 (of course), $b(i)$ to $\bar{b}(i) = x^i \in A$, $ya(i)$ to 0 and $a(i)$ to $\bar{a}(i) = x^i \in A$.

In order to compute $HC_*(A)$ it suffices to understand the analogue \bar{d} of d on the complex C^{sm} . This will give rise to a new mixed complex $(C^{\text{sm}}, \bar{\delta}, \bar{d})$. Since obviously $d(\Omega_{q-1}^q) = 0$, it suffices to compute $d(b(i))$. It comes

$$d(b(i)) = ix^{i-1}dx(dy)^q + q(r+1)x^{i-1}dx(dy)^q.$$

We are not only working with Ω^q but also with Ω^{q+1} so it is necessary to refine our notation and write $b(i)_q$ for $b(i) \in \Omega_q^q$ and similarly $a(i)_q$ for $a(i) \in \Omega_{q-1}^q$. Hence

$$d(b(i)_q) = (i + q(r+1))a(i-1)_{q+1} \quad \text{and} \quad d(b(0)_q) = 0.$$

This determines \bar{d} completely

$$\bar{d}(\bar{a}(i)_q) = 0 \quad \text{and} \quad \bar{d}(\bar{b}(i)_q) = (i + q(r+1))\bar{a}(i)_{q+1} \quad \text{for} \quad 0 \leq i \leq r.$$

It shows that $(\Omega^*, \delta, d) \rightarrow (C^{\text{sm}}, \bar{\delta}, \bar{d})$ is a map of mixed complexes. Restricted to (Ω^*, δ) it is a quasi-isomorphism, so we have proved the following

5.4.16 Proposition. *Let $\alpha(p) : k^r \rightarrow k^r$ be the diagonal matrix*

$$\alpha(p) = \text{diag}(1 + p(r+1), \dots, i + p(r+1), \dots, r + p(r+1)).$$

The mixed complex $(C(A), b, B)$ is equivalent to the sum of the two mixed complexes (with the notation $\overset{b}{\underset{B}{\rightleftarrows}}$):

$$\dots \overset{0}{\underset{0}{\rightleftarrows}} k^r \overset{0}{\underset{\alpha(1)}{\rightleftarrows}} k^r \overset{0}{\underset{0}{\rightleftarrows}} k^r \overset{0}{\underset{\alpha(0)}{\rightleftarrows}} k^r \quad \text{and} \quad \dots \overset{r+1}{\underset{0}{\rightleftarrows}} k \overset{0}{\underset{0}{\rightleftarrows}} k \overset{r+1}{\underset{0}{\rightleftarrows}} k \overset{0}{\underset{0}{\rightleftarrows}} k.$$

Proof. From the following equivalences of mixed complexes (cf. Theorem 5.4.7)

$$(C(A), b, B) \rightarrow (\Omega^*, \delta, d) \rightarrow (C^{\text{sm}}, \bar{\delta}, \bar{d})$$

it suffices to make the last one explicit. Indeed C_*^{sm} is isomorphic to $A = k1 \oplus kx \oplus \dots \oplus kx^r$ in all dimensions. We write it $k \oplus k^r$ when $*$ is even and $k^r \oplus k$ when $*$ is odd. By the above computation $\bar{\delta}$ is alternatively 0 or the matrix $\begin{pmatrix} 0 & r+1 \\ 0 & 0 \end{pmatrix}$ and \bar{d} is alternatively the matrix $\begin{pmatrix} 0 & \alpha(q) \\ 0 & 0 \end{pmatrix} : C_{2q} \rightarrow C_{2q+1}$ or 0. It is immediate to see that this mixed complex splits as announced. \square

5.4.17 Corollary. *For any commutative ring k , one has*

$$HC_{2q}(k[x]/x^{r+1}) \cong k \oplus (r+1)k^q \oplus k^r \oplus \text{Ker } \alpha(0) \oplus \dots \oplus \text{Ker } \alpha(q-1),$$

$$HC_{2q-1}(k[x]/x^{r+1}) \cong (k/(r+1)k)^q \oplus \text{Coker } \alpha(0) \oplus \dots \oplus \text{Coker } \alpha(q-1),$$

where

$$\text{Ker } \alpha(p) = \bigoplus_{1 \leq i \leq r} ((i+p(r+1))k)$$

and

$$\text{Coker } \alpha(p) = \bigoplus_{1 \leq i \leq r} (k/(i+p(r+1))k). \quad \square$$

5.4.18 Weights. Note that the description of the generators of these groups in terms of x and dx (see 5.4.15) indicates immediately what their x -weight and their λ -weight is. Remark also that this computation is consistent with the result given in Exercise E.4.1.8 in the characteristic 0 framework:

$$HC_{2q}(A) = HC_{2q}^{(q)}(A) \cong k^{r+1} \quad \text{and} \quad HC_{2q-1}(A) = 0.$$

Exercises

E.5.4.1. Use Theorem 5.4.12 to give a different proof of the computation of $HC_*(k[x]/x^{r+1})$ in the characteristic 0 framework.

E.5.4.2. Use Proposition 5.4.16 to make explicit B , I and S for $A = k[x]/x^{r+1}$, and compute $HC_*^-(A)$ and $HC_*^{\text{per}}(A)$.

E.5.4.3. Use the method of this section to compute $HC_*(k[x, y]/xy)$. [There is a model with $V_0 = kx \oplus ky$, $V_1 = kz$ and $\delta(z) = xy$.]

5.5 Bivariant Cyclic Cohomology

A priori the natural definition for bivariant cyclic cohomology is to take $\text{Ext}_{\Delta C_{\text{op}}}^*(E, E')$, where E and E' are cyclic modules. The derived functor Ext is computed in the abelian category of cyclic modules, which is in fact the category of contravariant functors from the cyclic category to the category of k -modules (see the next chapter). This version has not been studied in details so far, however a slightly different version with interesting properties has been developed by J.D.S. Jones and C. Kassel [1989]. The following is a

short account of this theory in the framework of k -algebras. Details are to be found in loc. cit.

Bivariant cyclic cohomology is a functor $HC^n(A, B)$, depending on two k -algebras A and B , which is contravariant in A and covariant in B . It has the same kind of properties as cyclic homology and cohomology: periodicity exact sequence, existence of products and coproducts, λ -decomposition, etc. It permits us to interpret some results in cyclic homology elegantly and it seems to be the right receptacle for characteristic classes coming from bivariant K -theory (Kasparov KK -theory).

Unless otherwise explicitly stated A and B are unital k -algebras.

5.5.1 Bivariant Hochschild Cohomology. Let $C(A)$ (resp. $C(B)$) be the Hochschild complex of A (resp. B). The graded module of graded maps $\text{Hom}(C(A), C(B))$ is in fact a complex with differential ∂ given by

$$\partial(f) = bf - (-1)^{|f|}fb .$$

Recall that $f \in \text{Hom}(C(A), C(B))$ is homogeneous of degree n if it sends $C_p(A)$ into $C_{p+n}(B)$ for all p .

5.5.5.1 By definition *bivariant Hochschild cohomology* of (A, B) is

$$HH^n(A, B) := H_{-n}(\text{Hom}(C(A), C(B)), \partial) , \quad n \in \mathbb{Z} .$$

Note that the index n varies in \mathbb{Z} .

Obviously the functor $HH^n(-, -)$ is contravariant in the first variable and covariant in the second one. Since the normalized Hochschild complex $\overline{C}(A)$ is a deformation retract of $C(A)$, one can as well replace C by \overline{C} in the definition of $HH^n(-, -)$.

The comparison with Hochschild homology and cohomology is given by the following identification:

$$HH^n(k, A) = HH_{-n}(A) = H_{-n}(A, A) ,$$

$$HH^n(A, k) = HH^n(A) = H^n(A, A^*) .$$

5.5.2 Definition of Bivariant Cyclic Cohomology. Since A and B are supposed to be unital one can work with the bicomplex $\mathcal{B}(-)$ or even the reduced version $\overline{\mathcal{B}}(-)$ (cf. Sect. 2.2). To simplify the notation we simply write $\mathcal{B}(A)$ in place of $\text{Tot}\mathcal{B}(A)$. Recall that this complex comes equipped with a degree -2 endomorphism $S : \mathcal{B}(A) \rightarrow \mathcal{B}(A)$, which is obtained by factoring out by the first column (at the bicomplex level). In particular this endomorphism is surjective and its kernel is $C(A)$.

By $\text{Hom}^S(\mathcal{B}(A), \mathcal{B}(B))$ we denote the submodule of $\text{Hom}(\mathcal{B}(A), \mathcal{B}(B))$ of elements which commute with S . Remark that a homogeneous map F of degree n which commutes with S is completely determined by its value on

the first component $C_*(A)$ of $\mathcal{B}_*(A) = C_*(A) \oplus C_{*-2} \oplus C_{*-4}(A) \oplus \dots$, and conversely.

5.5.2.1 By definition *bivariant cyclic cohomology* of (A, B) is

$$HC^n(A, B) := H_{-n}(\text{Hom}^S(\mathcal{B}(A), \mathcal{B}(B)), \partial).$$

This definition makes sense since $\partial(f)$ commutes with S as soon as f does. Again the functor $HC^n(-, -)$ is contravariant in the first variable and covariant in the second.

5.5.2.2 Remark that a map $F \in \text{Hom}^S(\mathcal{B}(A), \mathcal{B}(B))$ is a cocycle if and only if it is a map of complexes.

5.5.2.3 For any other k -algebra R there is a convenient map $HC^n(A, B) \rightarrow HC^n(A \otimes R, B \otimes R)$ (and similarly with $R \otimes -$ in place of $- \otimes R$) obtained as follows. Upon tensoring with the identity any $F \in \text{Hom}^S(\mathcal{B}(A), \mathcal{B}(B))$ gives rise to $F \otimes^S 1 \in \text{Hom}^S(\mathcal{B}(A) \otimes \mathcal{B}(R), \mathcal{B}(B) \otimes \mathcal{B}(R))$, which makes the following diagram commutative

$$\begin{array}{ccccccc} 0 & \rightarrow & \mathcal{B}(C(A) \otimes C(R)) & \rightarrow & \mathcal{B}(A) \otimes \mathcal{B}(R) & \rightarrow & (\mathcal{B}(A) \otimes \mathcal{B}(R))[2] \rightarrow 0. \\ & & \downarrow F \otimes^S 1 & & \downarrow F \otimes 1 & & \downarrow F \otimes 1 \\ 0 & \rightarrow & \mathcal{B}(C(B) \otimes C(R)) & \rightarrow & \mathcal{B}(B) \otimes \mathcal{B}(R) & \rightarrow & (\mathcal{B}(B) \otimes \mathcal{B}(R))[2] \rightarrow 0. \end{array}$$

(cf. Lemma 4.3.9 and remember that we write \mathcal{B} in place of $\text{Tot } \mathcal{B}$). Since $Sh : \mathcal{B}(C(A) \otimes C(R)) \rightarrow \mathcal{B}(C(A \otimes R)) = \mathcal{B}(A \otimes R)$ is a quasi-isomorphism (cf. 4.3.8), it follows that $F \otimes^S 1$ determines a well-defined element in $\text{Hom}^S(\mathcal{B}(A \otimes R), \mathcal{B}(B \otimes R))$, whence the desired map.

5.5.3 **Comparison with $HC^*(-, -)$ and HC_*^- .** By replacing $\mathcal{B}(B)$ by $\bar{\mathcal{B}}(B)$ in the definition and taking $B = k$, one sees immediately that

$$HC^n(A, k) = HC^n(A).$$

On the other hand if the second variable is taken to be the ground ring, then (cf. 5.1.7)

$$HC^n(k, A) = HC_{-n}^-(A).$$

5.5.4 **Theorem.** *For any unital k -algebras A and B there is a long exact sequence*

$$\begin{array}{ccccccc} \dots & \longrightarrow & HH^n(A, B) & \xrightarrow{I} & HC^n(A, B) & \xrightarrow{S} & HC^{n+2}(A, B) \\ & & & & & & \xrightarrow{B} HH^{n+1}(A, B) \xrightarrow{I} \dots \end{array}$$

Proof. Consider a homogeneous map F of degree n . It is completely determined by its restriction to $C_*(A)$ lying in $C_*(A) \oplus C_{*-2} \oplus C_{*-4}(A) \oplus \dots$, (cf.

5.5.2). The first component of this map is a homogeneous map of degree n which lies in $\text{Hom}(C(A), C(B))$ and it is clear that there is an exact sequence of complexes

$$0 \rightarrow \text{Hom}^S(\mathcal{B}(A), \mathcal{B}(B))[2] \rightarrow \text{Hom}^S(\mathcal{B}(A), \mathcal{B}(B)) \rightarrow \text{Hom}(C(A), C(B)) \rightarrow 0 .$$

Taking the homology gives the expected exact sequence. □

5.5.5 Composition Product. Since elements in bivariant Hochschild and cyclic homology are represented by maps of modules, one can compose them. It is a formality to show that this composition behaves well with the complex structure and passes to the homology. So, for three unital k -algebras A, A', A'' , composition of maps gives rise to functorial products, called *composition products*,

$$\begin{aligned} HH^p(A, A') \otimes HH^q(A', A'') &\rightarrow HH^{p+q}(A, A'') , \\ HC^p(A, A') \otimes HC^q(A', A'') &\rightarrow HC^{p+q}(A, A'') , \end{aligned}$$

which satisfy the obvious associativity condition.

One can even generalize slightly these products by the following formal manipulation (we write this in the setting of cyclic cohomology but everything is valid for Hochschild cohomology as well). Let A_1, A_2, A, A'_1, A'_2 be five unital k -algebras. There are natural maps

$$\begin{aligned} HC^p(A_1, A'_1 \otimes A) &\rightarrow HC^p(A_1 \otimes A_2, A'_1 \otimes A \otimes A_2) \quad \text{and} \\ HC^q(A \otimes A_2, A'_2) &\rightarrow HC^q(A_1 \otimes A \otimes A_2, A_1 \otimes A'_2) \quad (\text{cf. 5.5.2.2}) , \end{aligned}$$

that we can pair with the composition product to give a *generalized composition product*

$$HC^p(A_1, A'_1 \otimes A) \otimes HC^q(A \otimes A_2, A'_2) \rightarrow HC^{p+q}(A_1 \otimes A_2, A'_1 \otimes A'_2) .$$

The example $A'_1 = A = A'_2 = k$ gives the product in cyclic homology described in 4.4.10. The example $A_1 = A = A_2 = k$ gives the product for negative cyclic homology described in 5.1.13. The example $A_1 = A'_1 = A_2 = A'_2 = k$ gives the duality pairing between HC^* and HC^-_* (cf. 5.1.17).

5.5.6 Examples of Bivariant Cocycles. Several constructions and properties of the preceding chapters can be elegantly formulated in terms of bivariant cyclic cocycles.

5.5.6.1 Periodicity Operator. Since the endomorphism S of $\mathcal{B}(A)$ commutes with itself it gives rise to an element of degree 2 in $\text{Hom}^S(\mathcal{B}(A), \mathcal{B}(B))$ which is a cocycle since it is a morphism of complexes. Let us denote it by $[S] \in HC^2(A, A)$. The composition map $HC^2(A, A) \otimes HC^n(A, B) \rightarrow HC^{n+2}(A, B)$ evaluated on $[S]$ is the periodicity map (denoted by S) of the exact sequence 5.5.4.

5.5.6.2 Generalized Trace. Recall from 1.2.1 and 2.2.8 that the generalized trace map $\text{tr} : C(\mathcal{M}(A)) \rightarrow C(A)$ extends to a degree 0 map in $\text{Hom}(\mathcal{B}(\mathcal{M}(A)), \mathcal{B}(A))$. It obviously commutes with S and is a map of complexes, so it determines an element $[\text{tr}] \in HC^0(\mathcal{M}(A), A)$.

5.5.6.3 Derivation. In Sect. 4.1 we showed that any derivation D of A gives rise to a map of complexes $L_D : \mathcal{B}(A) \rightarrow \mathcal{B}(A)$. Since it commutes with S it determines $[L_D] \in HC^0(A, A)$. When D is an inner derivation $D = ad(u)$ for some element $u \in A$, then proposition 4.1.5 can be reinterpreted as: $L_{ad(u)}$ is a coboundary (image of $h(u)$), that is $[L_{ad(u)}] = 0$. So there is a well-defined functorial map

$$H^1(A, A) \rightarrow HC^0(A, A), \quad [D] \mapsto [L_D].$$

Remark that the image of this morphism lands in $\text{Ker}(S : HC^0(A, A) \rightarrow HC^2(A, A))$ since by Theorem 4.1.10 $L_D \circ S = 0$. The composition product makes $HC^0(A, A)$ into an associative algebra over k , whence a Lie algebra structure by $[x, y] = xy - yx$. It is immediate to check that the above map is a Lie algebra map (cf. Sect. 10.1).

5.5.7 Miscellaneous Variations

5.5.7.1 Non-unital Algebras. For non-unital algebras the correct complex to start with to define cyclic homology (resp. Hochschild homology) is the cyclic bicomplex $CC(A)$ (resp. the first two columns of $CC(A)$). Hence in the definition of bivariant cyclic cohomology it suffices to replace \mathcal{B} by CC (resp. similarly for HH) (cf. Exercise E.5.5.3).

5.5.7.2 λ -Decomposition of $HC^*(-, -)$. In characteristic zero, the properties of the Euler idempotents $e_n^{(i)}$, as described in 4.4 and 4.5, can be used to show that there is a canonical decomposition

$$HC^n(A, B) = \bigoplus_{i \in \mathbb{Z}} HC_{(i)}^n(A, B).$$

Remark that for a fixed integer n the integer i ranges over \mathbb{Z} (there is no reason to have a finite number of pieces in general).

5.5.7.3 Dihedral, Periodic, etc. We leave to the reader the opportunity of defining and studying bivariant dihedral cohomology, bivariant periodic cyclic cohomology, etc. It is also clear from the definition that one can extend the bivariant theory to cyclic modules as well.

Exercises

E.5.5.1. Prove that $HC^*(A, B)$ is Morita invariant in A and B .

E.5.5.2. Show that there exists a natural map $H^*(A, A)[1] \rightarrow HC^*(A, A)$ which is a Lie algebra map (cf. Exercise E.4.1.4) and which extends the case $* = 1$ described in 5.5.6.3).

E.5.5.3. Define bivariant cyclic cohomology of non-unital algebras by using the general principle explained in 1.4.1. Show that it gives the same result as the one indicated in (5.5.7.1).

E.5.5.4. Show that the composition product is consistent with the λ -decomposition, in the sense that it sends $HC_{(i)}^p \otimes HC_{(j)}^q$ into $HC_{(i+j)}^{p+q}$ (cf. Nuss [1992]).

5.6 Topological Algebras, Entire Cyclic Cohomology

When the algebra A has a topology it is interesting in some cases to take into account this topology in the definition of Hochschild and cyclic homology. In the homological framework this requires to use a modified tensor product à la Grothendieck. In the cohomological framework it is slightly easier since it suffices to use continuous cochains.

Moreover this topology on the algebra can be used to modify the definition of periodic cyclic cohomology by introducing a growth condition. This gives rise to a more subtle theory called *entire cyclic cohomology* which is of significant importance in the applications, in particular in the proof of most cases of the Novikov conjecture (cf. Connes-Moscovici [1990] and Connes-Gromov-Moscovici [1990, 1992]).

This section is a brief exposition without proofs. It is entirely due to A. Connes [C, 1988].

In this section $k = \mathbb{R}$ or \mathbb{C} .

Notation. For any locally compact space X the algebra of complex (or real) continuous functions on X is denoted $\mathcal{C}(X)$, and $\mathcal{C}_0(X)$ for the functions which vanish at infinity. For any C^∞ -manifold V , $C^\infty(V)$ denotes the algebra of C^∞ -functions on M .

5.6.1 Locally Convex Algebras. A *locally convex algebra* is a k -algebra A endowed with a locally convex Hausdorff topology for which the product $A \times A \rightarrow A$ is continuous. This means that for any continuous semi-norm p on A there exists a continuous semi-norm p' such that $p(xy) \leq p'(x)p'(y)$, $x, y \in A$. In general we assume that A is complete.

5.6.2 Topological Tensor Product and Homology. In order to take into account the topology of the algebra in the construction of Hochschild and cyclic homology one topologizes the tensor product to obtain the *projective tensor product* $\hat{\otimes}_\pi$ (cf. Grothendieck [1955]). This completion has the following property: for any compact differentiable manifold V there is a topological isomorphism $C^\infty(V) \hat{\otimes}_\pi C^\infty(V) \cong C^\infty(V \times V)$.

In the Hochschild complex, one replaces $A \otimes \dots \otimes A$ by $A \hat{\otimes}_\pi \dots \hat{\otimes}_\pi A$ (we suppose here that A is complete). This gives a well-defined complex whose homology is still denoted by $HH_*(A)$. Similarly one defines topological cyclic homology $HC_*(A) = H_*^\lambda(A)$. All the properties of the previous chapters extend to these new groups, in particular the Morita invariance and Connes periodicity exact sequence. Note that, in the case of the Morita invariance, not only $\mathcal{M}_n(A)$ has the same homology as A , but also $A \hat{\otimes}_\pi \mathcal{K}$ has the same homology as A where \mathcal{K} is the algebra of trace class operators.

The only difficulty is in the analysis of the topology of the homology and cohomology groups, which are not separated in general.

5.6.3 Cohomology Theories. It is slightly easier to deal with the cohomology theories since then we do not need to appeal to $\hat{\otimes}_\pi$. Indeed let $C^n(A)$ be the space of continuous $(n + 1)$ -linear functionals on A . This means that $\phi : A^n \rightarrow k$ is in $C^n(A)$ if and only if for some continuous semi-norm p on A one has

$$|\phi(a_0, \dots, a_n)| \leq p(a_0) \dots p(a_n), \quad a_i \in A.$$

Remark that replacing A by its completion does not change $C^n(A)$. By using this new space of multilinear functionals one can define *continuous Hochschild cohomology* $HH^*(A)$ and also *continuous cyclic cohomology* $HC^*(A) (= H_\lambda^*(A))$ like in the algebra case. Most of the properties can be extended to the topological case, for instance there is a long exact sequence

$$\dots \rightarrow HH^n(A) \rightarrow HC^{n-1}(A) \rightarrow HC^{n+1}(A) \rightarrow HH^{n+1}(A) \rightarrow \dots$$

Carefulness is in order when dealing with duality properties.

5.6.4 Example 1: $C^\infty(V)$. Let V be a compact smooth (i.e. differentiable) manifold. The algebra $C^\infty(V)$ of differentiable functions on V is a Fréchet algebra. Since $C^\infty(V) \hat{\otimes}_\pi C^\infty(V) = C^\infty(V \times V)$ the Hochschild complex (with $C^\infty(V^{n+1})$ in dimension n) is a familiar one. Connes [C] extended the computation of Hochschild-Kostant-Rosenberg to this context and proved that $HH^*(C^\infty(V))$ is the space of de Rham currents on V . He also showed that the operator B corresponds to the de Rham boundary of currents under this identification.

As a consequence

$$HC_0^{\text{per}}(C^\infty(V)) \oplus HC_1^{\text{per}}(C^\infty(V)) = H^*(V, \mathbb{C}).$$

5.6.5 Example 2: The Non-commutative Torus. In this example $k = \mathbb{C}$. Let $\theta \in \mathbb{R}/\mathbb{Z}$ and put $\lambda = \exp(2\pi i\theta)$. By definition the algebra \mathcal{A}_θ of the *non-commutative torus* is made of the elements

$$\sum_{n,m \in \mathbb{Z}} a_{n,m} x^n y^m$$

where $(a_{n,m})$ is a sequence of rapid decay ($(|n| + |m|)^q |a_{n,m}|$ is bounded for any $q \in \mathbb{N}$). The product is specified by the relation $xy = \lambda yx$. If $\theta = 0$, then $\lambda = 1$ and by Fourier analysis \mathcal{A}_0 is the algebra of the commutative torus, that is $C^\infty(S^1 \times S^1)$. In fact if $\theta \in \mathbb{Q}/\mathbb{Z}$, then \mathcal{A}_θ is Morita equivalent to $C^\infty(S^1 \times S^1)$.

Computation of HH and HC of \mathcal{A}_θ has been performed by Connes [C]. Here are the results for non-commutative de Rham cohomology:

$$HC_0^{\text{per}}(\mathcal{A}_\theta) \cong \mathbb{C}^2 ,$$

$$HC_1^{\text{per}} = HH_1(\mathcal{A}_\theta)/\text{Im } B_* \cong \mathbb{C}^2 .$$

Moreover explicit generators are described as follows. Let δ_1 and δ_2 be the derivations of \mathcal{A}_θ given by

$$\delta_1(x^n y^m) = 2\pi i n x^n y^m \quad \text{and} \quad \delta_2(x^n y^m) = 2\pi i m x^n y^m .$$

Then $\phi(a_0, a_1, a_2) = a_0(\delta_1(a_1)\delta_2(a_2) - \delta_2(a_1)\delta_1(a_2))$ determines a cyclic 2-cocycle ϕ whose class is a non-trivial element. Another (and linearly independent) element is given by $S\tau$ where τ is the canonical trace ($\tau(x) = \tau(y) = 0$ and $\tau(1) = 1$).

5.6.6 Example 3: C^* -Algebra of a Foliation. To any foliation F on a smooth compact manifold V one can associate a C^* -algebra $\mathcal{C}(V, F)$ (cf. Connes [1982]). Let us just mention that if the foliation comes from a submersion $V \rightarrow B$, then this C^* -algebra is Morita equivalent to $\mathcal{C}_0(B)$. For the foliation of the torus by lines of slope θ the associated C^* -algebra is Morita equivalent to the completion of the algebra \mathcal{A}_θ introduced above. In Sect. 12.1 we show how the Godbillon-Vey class of F can be seen as a cyclic cocycle of a dense subalgebra of $\mathcal{C}(V, F)$.

5.6.7 Example 4: Reduced C^* -Algebra. Let G be a discrete and countable group. The left regular representation λ of G in the Hilbert space $l^2(G)$ is given by

$$(\lambda(s)\xi)(t) = \xi(s^{-1}t) , \quad s, t \in G .$$

The associated $*$ -homomorphism

$$\lambda : \mathbb{C}[G] \rightarrow \mathcal{L}(l^2(G))$$

is faithful and given by convolution on the left

$$\lambda(f)\xi(t) = f*\xi(t) = \sum_{s \in G} f(s)\xi(s^{-1}t) , \quad f \in \mathbb{C}[G] , \quad \xi \in l^2(G) .$$

By definition the *reduced C^* -algebra* $C_r^*(G)$ is the norm closure of $\lambda(\mathbb{C}[G])$ in $\mathcal{L}(l^2(G))$. For instance $C_r^*(\mathbb{Z}) = \mathcal{C}_0(S^1)$. The inclusion $\mathbb{C}[\mathbb{Z}] = \mathbb{C}[z, z^{-1}] \hookrightarrow \mathcal{C}_0(S^1)$ consists in viewing a Laurent polynomial as a function on S^1 parametrized by $z \in \mathbb{C}$, $|z| = 1$. More generally if G is a discrete abelian group,

then $C_r^*(G)$ is the C^* -algebra of complex valued continuous functions on the Pontrjagin dual $\hat{G} = \text{Hom}(G, S^1)$. Algebraic K -theory and cyclic homology of dense subalgebras of $C_r^*(G)$ play an important role in the Novikov conjecture (cf. Sect. 12.3).

5.6.8 Entire Cyclic Cohomology. Consider the (b, B) -bicomplex $\mathcal{BC}_{**}^{\text{per}}(A)$ (cf. Sect. 2.1) of the unital Banach \mathbb{C} -algebra A , whose norm is denoted by $\|\cdot\|$. If one forms the total complex by taking the direct sum on each diagonal, then we already mentioned that one gets trivial homology groups. If one takes the direct product, then this gives periodic cyclic homology $HC_*^{\text{per}}(A)$.

Dually, if, in the cohomological bicomplex $\mathcal{BC}_{\text{per}}^{**}(A)$, one takes cochains with arbitrary support, then the total cohomology is trivial. If, on the other hand, one takes cochains with finite support, then the total cohomology is $HC_{\text{per}}^*(A)$. In the cohomological framework there is a refinement which consists in taking only the infinite sequences of cochains which satisfy a growth condition. Explicitly let

$$C^{\text{ev}} = \{(\phi_{2n})_{n \in \mathbb{N}}, \phi_{2n} \in C_{\text{top}}^{2n}(A)\}$$

and $C^{\text{odd}} = \{(\phi_{2n+1})_{n \in \mathbb{N}}, \phi_{2n+1} \in C_{\text{top}}^{2n+1}(A)\} .$

One modifies slightly the boundary maps in the bicomplex $\mathcal{BC}_{**}^{\text{per}}$ by putting (cf. Connes [1988a, p. 521])

$$d_1(\phi) = (n - m + 1)b(\phi) \quad \text{for } \phi \in C^{nm} ,$$

$$d_2(\phi) = \frac{1}{n - m}B(\phi) \quad \text{for } \phi \in C^{nm} .$$

So the total boundary operator is $\partial = d_1 + d_2$.

A continuous cochain $(\phi_{2n})_{n \in \mathbb{N}} \in C^{\text{ev}}$ (resp. $(\phi_{2n+1})_{n \in \mathbb{N}} \in C^{\text{odd}}$) is called *entire* iff the radius of convergence of $\sum \|\phi_{2n}\|z^n/n!$ (resp. $\sum \|\phi_{2n+1}\|z^n/n!$) is infinity. It is immediate to check that the boundary $\partial\phi$ of the entire cochain ϕ is still entire, and so there is a well-defined complex

$$C_\epsilon^{\text{ev}}(A) \xrightarrow{\partial} C_\epsilon^{\text{odd}}(A) \xrightarrow{\partial} C_\epsilon^{\text{ev}}(A) \xrightarrow{\partial} C_\epsilon^{\text{odd}}(A) ,$$

where $C_\epsilon^{\text{ev}}(A)$ (resp. $C_\epsilon^{\text{odd}}(A)$) is the space of entire cochains. By definition *entire cyclic cohomology* of the Banach algebra A is the homology of this small complex. It consists in two groups denoted

$$HC_\epsilon^{\text{ev}}(A) \quad \text{and} \quad HC_\epsilon^{\text{odd}}(A) \quad \text{respectively} .$$

Since the complex of cochains with finite support is a subcomplex of the complex of entire cochains, there is defined a canonical map

$$HC_{\text{per}}^*(A) \rightarrow HC_\epsilon^*(A) .$$

For $A = \mathbb{C}$ this map is an isomorphism, but in general this map is not even surjective. For some algebras the pairing of algebraic K -theory with HC_{per}^*

can be extended to HC_ε^* and this extension plays an important role in the applications (see 12.3.14). Notice that entire cyclic homology is defined for any *locally convex topological algebra* in Connes [1994], p. 370.

Bibliographical Comments on Chapter 5

§1. The idea of looking at the periodic complex, and so at the periodic theory, is already in the seminal article of Connes [C], see also Goodwillie [1985a]. The idea that the theory HC^- is relevant is due to Hood-Jones [1987], where they recognize this theory as the dual of the cyclic theory over $HC_*(k)$. Similar statements can be found in Feigin-Tsygan [FT]. The product structure on HC^- was introduced in Hood-Jones [1987] by using the acyclic model technique. De Rham cohomology has been generalized to crystalline cohomology by Grothendieck and the comparison with the periodic cyclic theory is done in Feigin-Tsygan [1987], see also Kassel [1987, cor. 3.12]. In the literature periodic cyclic homology is denoted either by HC^{per} (adopted here), or PHC , or HCP , or HP , or even simply H .

§2. Dihedral and quaternionic homology were introduced and studied in Loday [1987]. Independent and similar work appeared in Krasauskas-Lapin-Solovev [1987] and Krasauskas-Solovev [1986, 1988]. Subsequent work was done in Lodder [1990, 1992] and in Dunn [1989] where the relationship with $O(2)$ -spaces is also worked out. An interesting application to higher Arf invariants is done in Wolters [1992].

§3–4. The extension of HC to DG -algebras appeared in Vigué-Burghlelea [1985] and also Goodwillie [1985a]. The idea of getting a decomposition of HC from this point of view is in Burghlelea-Vigué [1988]. Extensive computations have been made in loc. cit., Brylinski [1987b], Vigué [1988, 1990], Geller-Reid-Weibel [1989], Bach [1992], Hanlon [1986]. Some of these results can be found in Feigin-Tsygan [FT].

§5. Bivariant cyclic cohomology was taken out from Jones-Kassel [1989], see also Kassel [1989a]. The λ -decomposition is in Nuss [1992].

§6. Some computations in the topological framework are done in Connes [C]. Entire cyclic cohomology is treated in Connes [1988] and used extensively for the proof of some cases of the Novikov conjecture in Connes-Moscovici [1990] and Connes-Gromov-Moscovici [1990]). Further work can be found in Connes-Gromov-Moscovici [1992]) (asymptotic cyclic cohomology, again in relationship with the Novikov conjecture). Many other papers relating the index theory and the entire cyclic cohomology are listed in the references.

Chapter 6. The Cyclic Category, Tor and Ext Interpretation

Simplicial objects in an arbitrary category \mathcal{C} can be described as functors from the category of non-decreasing maps Δ^{op} to \mathcal{C} . Similarly one can construct a category, denoted $\Delta\mathcal{C}$ and called *Connes cyclic category*, such that a cyclic object in \mathcal{C} can be viewed as a functor from $\Delta\mathcal{C}^{\text{op}}$ to \mathcal{C} . The cyclic category $\Delta\mathcal{C}$ was first described by Connes [1983, where it is denoted Λ or ΔK] who showed how it is constructed out of Δ and the finite cyclic groups.

It permits us to interpret cyclic homology as a Tor-functor and cyclic cohomology as an Ext-functor. An application to the relationship between cyclic homology and equivariant homology of S^1 -spaces will be given in the next chapter.

The relationship between the family of finite cyclic groups and Δ , given by the existence of $\Delta\mathcal{C}$, can be axiomatized to give a generalization of the simplicial groups called *crossed simplicial groups*. Examples of such are the families of dihedral groups, of quaternionic groups, of symmetric groups, of hyperoctahedral groups, of braid groups.

In the dihedral case it permits us to give a Tor (resp. Ext) interpretation of dihedral homology (resp. cohomology).

Section 6.1 describes fully the cyclic category $\Delta\mathcal{C}$ (and also the category ΔS where the cyclic groups are replaced by the symmetric groups). Section 6.2 is devoted to the Tor (resp. Ext) interpretation of Hochschild and cyclic homology (resp. cohomology). Section 6.3 deals with crossed simplicial groups and Sect. 6.4 with the category of finite sets and the relationship with the λ -operations. These last two sections are not necessary for the reading of the subsequent chapters if one is only interested in the cyclic theory.

The construction of $\Delta\mathcal{C}$ and the Tor and Ext interpretations are all due to A. Connes [1983]. The generalization to crossed simplicial groups is taken out from Fiedorowicz-Loday [1991], as well as the proof describing the structure of $\Delta\mathcal{C}$. The last section on the relationship with the category of finite sets follows Loday [1989].

We suppose that the reader is familiar with the category Δ whose definition and properties are recalled in Appendix B.

Standing Notation. The symmetric group S_{n+1} is identified with the automorphism group of the set $\{0, 1, \dots, n\}$. The opposite group is denoted S_{n+1}^{op}

(same set but opposite group structure). For $g \in S_{n+1}^{\text{op}}$, the corresponding element in S_{n+1} is denoted \bar{g} , hence $\overline{g'g} = \bar{g}'\bar{g}$.

6.1 Connes Cyclic Category ΔC and the Category ΔS

Connes cyclic category ΔC is a nice mixture of Δ and the cyclic groups. In fact it has the same objects as Δ and any morphism can be uniquely written as a composite of a morphism in Δ and an element of some finite cyclic group. Its structure is comparable to that of a group G which contains two subgroups A and B , and such that any element of G is uniquely the product of an element of A by an element of B (see Exercise E.6.1.1). Here the category Δ plays the role of A and the disjoint union of the finite cyclic groups plays the role of B . In the last part of the section we provide an isomorphism of ΔC with its opposite category (this is not true for Δ of course). For several reasons it is helpful to see ΔC as a subcategory of a category ΔS made out of Δ and the family of the finite symmetric groups.

6.1.1 Definition. The *cyclic category* ΔC has objects $[n]$, $n \in \mathbb{N}$, and morphisms generated by faces $\delta_i : [n-1] \rightarrow [n]$, $i = 0, \dots, n$, degeneracies $\sigma_j : [n+1] \rightarrow [n]$, $j = 0, \dots, n$, and cyclic operators $\tau_n : [n] \rightarrow [n]$, subject to the following relations:

- (a) $\delta_j \delta_i = \delta_i \delta_{j-1}$ for $i < j$,
 $\sigma_j \sigma_i = \sigma_i \sigma_{j+1}$ for $i \leq j$,
 $\sigma_j \delta_i = \begin{cases} \delta_i \sigma_{j-1} & \text{for } i < j \\ id_{[n]} & \text{for } i = j, i = j + 1 \\ \delta_{i-1} \sigma_j & \text{for } i > j + 1. \end{cases}$
- (b) $\tau_n \delta_i = \delta_{i-1} \tau_{n-1}$, for $1 \leq i \leq n$, $\tau_n \delta_0 = \delta_n$,
 $\tau_n \sigma_i = \sigma_{i-1} \tau_{n+1}$, for $1 \leq i \leq n$, $\tau_n \sigma_0 = \sigma_n \tau_{n+1}^2$,
- (c) $\tau_n^{n+1} = id$.

Remark that the relation $\tau \delta_0 = \delta_n$ is a consequence of the others, because $\delta_n = \tau^{n+1} \delta_n = \tau^n \delta_{n-1} \tau = \dots = \tau \delta_0 \tau^n = \tau \delta_0$. Similarly $\tau \sigma_0 = \sigma_n \tau^2$ is a consequence of the other relations.

The important property of ΔC is that any morphism can be written *uniquely* as the composite of a morphism in Δ and an element in a cyclic group C_n (see 6.1.3 below) of order $n + 1$, whence the notation ΔC .

It will be shown later (cf. 7.2.6) that the classifying space $B\Delta C$ is homotopy equivalent to $BS^1 = K(\mathbb{Z}, 2) = \mathbb{C}P^\infty$.

6.1.2 Presentation of ΔC^{op} and Cyclic Objects. For future reference let us give a presentation of ΔC^{op} . The notations are such that

$$\delta_i^* = d_i, \quad \sigma_j^* = s_j \quad \text{and} \quad \tau_n^* = t_n.$$

Generators of ΔC^{op} are

$$\begin{aligned} d_i &: [n] \rightarrow [n-1], \quad 0 \leq i \leq n, \\ s_j &: [n] \rightarrow [n+1], \quad 0 \leq j \leq n, \\ t_n &: [n] \rightarrow [n]. \end{aligned}$$

The relations are

- (a) $d_i d_j = d_{j-1} d_i$ for $i < j$,
 $s_i s_j = s_{j+1} s_i$ for $i \leq j$,
 $d_i s_j = \begin{cases} s_{j-1} d_i & \text{for } i < j, \\ id_n & \text{for } i = j, \quad i = j + 1, \\ s_j d_{i-1} & \text{for } i > j + 1. \end{cases}$
- (b) $d_i t_n = t_{n-1} d_{i-1}$ for $1 \leq i \leq n$ and $d_0 t_n = d_n$,
 $s_i t_n = t_{n+1} s_{i-1}$ for $1 \leq i \leq n$ and $s_0 t_n = t_{n+1}^2 s_n$,
- (c) $(t_n)^{n+1} = id_n$.

6.1.2.1 By definition a *cyclic object* in a category \mathcal{C} is a functor

$$X : \Delta C^{\text{op}} \rightarrow \mathcal{C}.$$

As usual the image by X of a morphism f in ΔC^{op} is denoted by f_* or, more often, simply by f , instead of $X(f)$. Sometimes we prefer to consider X as a *contravariant* functor from ΔC to \mathcal{C} , then the image by X of the morphism ϕ of ΔC is denoted by ϕ^* .

Composition with the obvious functor $\Delta^{\text{op}} \rightarrow \Delta C^{\text{op}}$ gives the *underlying simplicial object* of the cyclic object. It is still denoted by X or X_* .

6.1.2.2 For instance if \mathcal{C} is the category of modules ($k\text{-Mod}$), then a functor $C : \Delta C^{\text{op}} \rightarrow (k\text{-Mod})$ is equivalent to a cyclic module in the sense of 2.5.1. The point is to introduce the sign $(\text{sgn } t_n) = (-1)^n$ in front of t_n to get the right formulas. By abuse of language the functor C is still called a *cyclic module* (or *cyclic module without signs* if one wants to make clear which set of axioms is used). Cyclic sets and cyclic spaces will be studied from a topological point of view in Chap. 7.

6.1.3 Theorem. *The category ΔC contains Δ as a subcategory and*

- (1) *the group of automorphisms of $[n]$ in ΔC is cyclic of order $n + 1$,*
- (2) *any morphism from $[n]$ to $[m]$ in ΔC can be uniquely written as the composite $\phi \circ g$ with $\phi \in \text{Hom}_\Delta([n], [m])$ and $g \in \text{Aut}_{\Delta C}([n]) \cong \mathbb{Z}/(n + 1)\mathbb{Z}$.*

It will prove helpful to deduce this result from the following more general statement (for another proof see Exercise E.6.1.2).

6.1.4 Theorem. *There exists a category ΔS with objects $[n]$, $n \geq 0$, containing Δ as a subcategory and such that*

- (1) *the group of automorphisms of $[n]$ in ΔS is the group S_{n+1}^{op} ,*
- (2) *any morphism from $[m]$ to $[n]$ in ΔS can be uniquely written as the composite $\phi \circ g$ with $\phi \in \text{Hom}_{\Delta}([n], [m])$ and $g \in \text{Aut}_{\Delta S}([n]) \cong S_{n+1}^{\text{op}}$.*

Proof of Theorem 6.1.4. Recall that any $\phi \in \text{Hom}_{\Delta}([m], [n])$ can be considered as a set-map from $[m] = \{0, 1, \dots, m\}$ to $[n] = \{0, 1, \dots, n\}$. In fact it is a non-decreasing map for the obvious order on these sets (cf. Appendix B).

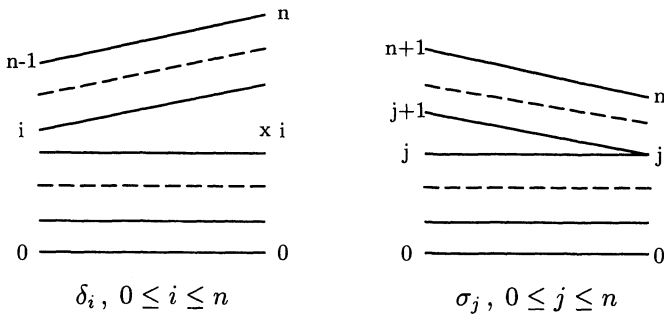

For any $g \in S_{n+1}^{\text{op}}$, corresponding to $\bar{g} \in S_{n+1}$, we consider the following set map

$$(6.1.4.1) \quad g : [n] \rightarrow [n], \quad g(i) = \bar{g}^{-1}(i).$$

The main technical point of the proof is the following

6.1.5 Lemma. *Given $\phi \in \text{Hom}_{\Delta}([m], [n])$ and $g \in S_{n+1}^{\text{op}}$ there exist a unique element $g_*(\phi) \in \text{Hom}_{\Delta}([m], [n])$ and a unique element $\phi^*(g) \in S_{m+1}^{\text{op}}$ such that*

- (i) *the following set diagram is commutative*

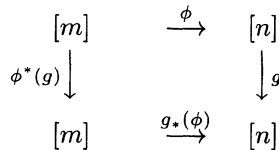

- (ii) *the restriction of $\phi^*(g)$ to each subset $\phi^{-1}(i)$, for $i = 0, \dots, n$, preserves the order.*

Proof. A morphism ϕ in Δ is completely determined by the sequence of numbers $\#\phi^{-1}(i)$, $i = 0, \dots, n$ ($\#$ means number of elements of). In order

to fulfill condition (i), $\#g_*(\phi)^{-1}(i)$ has to be equal to $\#(g \circ \phi)^{-1}(i)$, which determines $g_*(\phi)$ uniquely.

To determine $\phi^*(g)$ it is sufficient to get it on $\phi^{-1}(i)$. By condition (ii) there is only one possibility. The following figure illustrates a particular case:

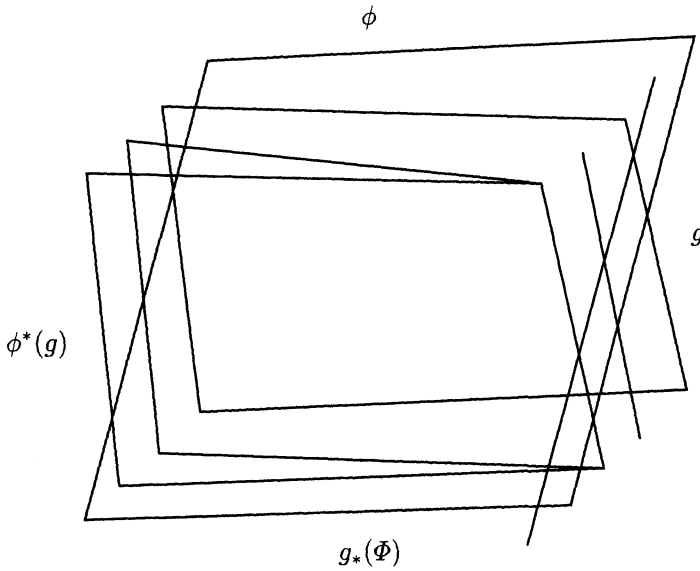

□

6.1.6 Proposition. *The maps $g_* : \text{Hom}_\Delta([m], [n]) \rightarrow \text{Hom}_\Delta([m], [n])$ for $g \in S_{n+1}^{\text{op}}$ and $\phi^* : S_{n+1}^{\text{op}} \rightarrow S_{m+1}^{\text{op}}$ for $\phi \in \text{Hom}_\Delta([m], [n])$ satisfy the following rules (where \circ is either composition in Δ or composition in S_{n+1}^{op}):*

- 1.h. $(\phi \circ \phi')^*(g) = \phi'^*(\phi^*(g))$,
- 1.v. $(g \circ g')_*(\phi) = g_*(g'_*(\phi))$,
- 2.h. $g_*(\phi \circ \phi') = g_*(\phi) \circ (\phi^*(g))_*(\phi')$,
- 2.v. $\phi^*(g \circ g') = (g'_*(\phi))^*(g) \circ \phi^*(g')$,
- 3.h. $(id_n)^*(g) = g$ and $\phi^*(1_n) = 1_n$,
- 3.v. $(1_n)_*(\phi) = \phi$ and $g_*(id_n) = id_n$.

Proof. Each formula is a consequence of the preceding lemma. Let us prove 1.h and 2.h in details.

Consider the following set diagrams

$$\begin{array}{ccccc}
 [l] & \xrightarrow{\phi'} & [m] & \xrightarrow{\phi} & [n] & & [l] & \xrightarrow{\phi \circ \phi'} & [n] \\
 \phi'^*(\phi^*(g)) \downarrow & & \downarrow \phi^*(g) & & g \downarrow & & (\phi \circ \phi')^*(g) \downarrow & & \downarrow g \\
 [l] & \xrightarrow{\phi^*(g)_*(\phi')} & [m] & \xrightarrow{g_*(\phi)} & [n] & & [l] & \xrightarrow{g_*(\phi \circ \phi')} & [n]
 \end{array}$$

Let us verify that on the left-hand side the maps $g_*(\phi) \circ (\phi^*(g))_*(\phi')$ and $\phi'^*(\phi^*(g))$ satisfy the conditions of Lemma 6.1.5 with respect to $\phi \circ \phi'$ and g . It is immediate for condition (i). For condition (ii) we remark that the set $(\phi \circ \phi')^{-1}(i)$ is made of the (ordered) union of subsets. The map $\phi'^*(\phi^*(g))$ preserves the order of the subsets and preserves the order in each subset, therefore the order of the union is also preserved.

By uniqueness of Lemma 6.1.5 we get identifications with the corresponding maps in the right-hand side diagram. This proves formulas 1.h and 2.h. The other formulas are proved similarly by looking at ad hoc diagrams. \square

End of the Proof of Theorem 6.1.4. Define a morphism in ΔS as a pair (ϕ, g) with $\phi \in \text{Hom}_\Delta([n], [m])$ and $g \in S_{n+1}^{\text{op}}$. Composition is defined by

$$(\phi, g) \circ (\psi, h) := (\phi \circ g_*(\psi), \psi^*(g) \circ h),$$

where we use composition in Δ and in S_{n+1}^{op} .

Associativity is a consequence of formulas 1 and 2 of 6.1.6. The existence of identities $(id_n, 1_n)$ is a consequence of formulas 3 of 6.1.6. Hence ΔS is a well-defined category.

A morphism ϕ of Δ is identified with $(\phi, 1_n)$ and composition of such elements is as in Δ . So Δ is a subcategory of ΔS .

An element g of S_{n+1}^{op} is identified with (id_n, g) and composition of such elements is as in S_{n+1}^{op} . From the definition of composition and relations 3 of 6.1.6 we get

$$(\phi, g) = (\phi, 1_n) \circ (id_n, g) = \phi \circ g,$$

and this proves condition (2).

An automorphism of ΔS is of the form (id_n, g) , because the only automorphisms in Δ are the identities. Therefore $\text{Aut}_{\Delta S}([n]) = S_{n+1}^{\text{op}}$, which proves condition (1). \square

Proof of Theorem 6.1.3. Let t_n be the cycle $(0\ 1\ \dots\ n)$ in S_{n+1} , that is $t_n(i) = i + 1$ for $0 \leq i < n$ and $t_n(n) = 0$. It generates the cyclic group $\mathbf{C}_n = \mathbb{Z}/(n+1)\mathbb{Z}$ in S_{n+1} . Denote by τ_n the corresponding element in S_{n+1}^{op} (with our previous notation $\bar{\tau}_n = t_n$).

From the definition of ϕ^* we compute $\delta_i^*(\tau_n) = \tau_{n-1}$ for $i = 1, \dots, n$ and $\delta_0^*(\tau_n) = 1_{n-1}$ and also $\sigma_i^*(\tau_n) = \tau_{n+1}$ for $i = 1, \dots, n$, and $\sigma_0^*(\tau_n) = \tau_{n+1}^2$. Therefore Δ and the cyclic groups \mathbf{C}_n generate a subcategory of ΔS .

In order to verify that this is ΔC as defined in 6.1.2 it suffices now to check that $\tau_n^*(\delta_i) = \delta_{i-1}$ for $i = 1, \dots, n$, and $\tau_n^*(\delta_0) = \delta_n$, and also that $\tau_n^*(\sigma_i) = \sigma_{i-1}$ for $i = 1, \dots, n$, and $\tau_n^*(\sigma_0) = \sigma_n$. For instance

$$\tau_n \circ \delta_i = (\tau_n)_*(\delta_i) \circ (\delta_i)^*(\tau_n) = \delta_{i-1} \circ \tau_{n-1} \quad \text{for } i = 1, \dots, n :$$

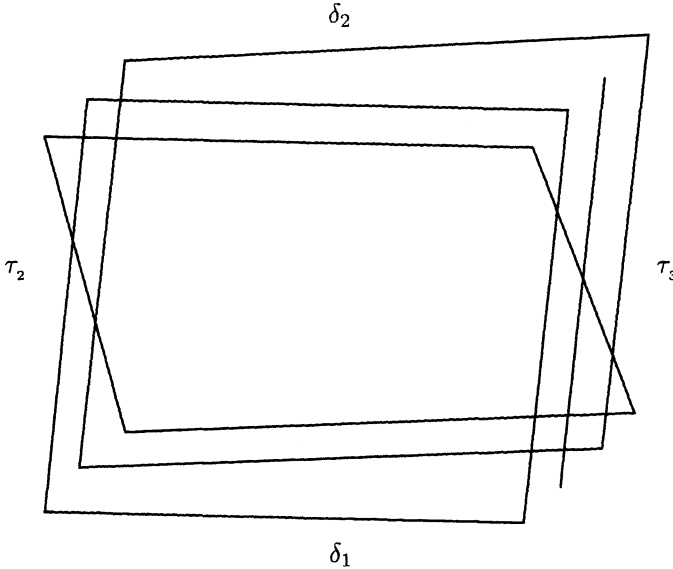

□

6.1.7 Corollary. *Under the identifications made in the above proof we have the following formula in ΔS (and hence in ΔC):*

$$g \circ \phi = g_*(\phi) \circ \phi^*(g) . \quad \square$$

6.1.8 The Categories ΔS^{op} and ΔC^{op} . Let us summarize the preceding results for the category ΔS^{op} . It is clear that ΔS^{op} contains Δ^{op} as a subcategory and contains all the symmetric groups S_{n+1} as $\text{Aut}_{\Delta S^{\text{op}}}([n])$. Moreover any morphism in ΔS^{op} can be uniquely written $\sigma \circ f$ with $\sigma \in S_{n+1}$ and $f \in \text{Hom}_{\Delta^{\text{op}}}([m], [n])$. For any $\omega \in S_{n+1}$ and f as above there exist unique elements $f_*(\omega) \in S_{n+1}$ and $\omega^*(f)$ in $\text{Hom}_{\Delta^{\text{op}}}([m], [n])$ such that

$$f \circ \omega = f_*(\omega) \circ \omega^*(f) .$$

In particular if $f = d_i$ (resp. s_i), then $\omega^*(d_i) = d_j$ (resp. $\omega^*(s_i) = s_j$) where $j = \omega^{-1}(i)$.

If ω is in the cyclic group C_n of S_{n+1} generated by the cyclic permutation t_n , then $f_*(\omega)$ is in C_m .

6.1.9 Proposition. *The family of cyclic groups $C_n := \text{Aut}_{\Delta C^{\text{op}}}([n])$ (of order $n + 1$), $n \geq 0$, forms a cyclic set (and in particular a simplicial set).*

Proof. For any $a \in \text{Hom}_{\Delta C^{\text{op}}}([m], [n])$ and any $g \in \mathbf{C}_m$ there exist unique elements $a_*(g) \in \mathbf{C}_n$ and $g^*(a) \in \text{Hom}_{\Delta^{\text{op}}}([m], [n])$ such that $a \circ g = a_*(g) \circ g^*(a)$. From the associativity of the composition in ΔC^{op} we deduce that $a'_*(a_*(g)) = (a' \circ a)_*(g)$ where $a' \in \text{Hom}_{\Delta C^{\text{op}}}([n], [n'])$. This shows that the functor $\mathbf{C}. : \Delta C^{\text{op}} \rightarrow (\text{Sets})$ given by $[n] \mapsto \mathbf{C}_n$ and $a \mapsto a_*$ is well-defined. \square

6.1.10 The Explicit Structure of $\mathbf{C}.$ Let $t_n \in \mathbf{C}_n$ be the dual of τ_n as in 6.1.2. From the formula $d_i \circ t_n = d_{i*}(t_n) \circ t_n^*(d_i)$ in ΔC^{op} we deduce from (6.1.2.b) that

$$\begin{aligned} d_i(t_n) &:= d_{i*}(t_n) = t_{n-1} \quad \text{and} \quad t_n^*(d_i) = d_{i-1} \quad \text{for} \quad 1 \leq i \leq n, \\ d_0(t_n) &:= d_{0*}(t_n) = id \quad \text{and} \quad t_n^*(d_0) = d_n. \end{aligned}$$

Similarly we get for degeneracies

$$\begin{aligned} s_i(t_n) &:= s_{i*}(t_n) = t_{n+1} \quad \text{and} \quad t_n^*(s_i) = s_{i-1} \quad \text{for} \quad 1 \leq i \leq n, \\ s_0(t_n) &:= s_{0*}(t_n) = t_{n+1}^2 \quad \text{and} \quad t_n^*(s_0) = s_n. \end{aligned}$$

As a simplicial set $\mathbf{C}.$ has only two non-degenerate cells, t_0 and t_1 . Hence its geometric realization is the circle S^1 (cf. 7.1.2).

6.1.11 Proposition. *The category ΔC is isomorphic to its opposite ΔC^{op} . Therefore there is an inclusion of categories $\Delta^{\text{op}} \rightarrow \Delta C^{\text{op}} \cong \Delta C \rightarrow \Delta S$.*

Proof. One first constructs an *extra degeneracy* $\sigma_{n+1} : [n+1] \rightarrow [n]$ in ΔC by putting

$$\sigma_{n+1} := \sigma_0 \tau_{n+1}^{-1}.$$

Hence formula $\tau_n \sigma_i = \sigma_{i-1} \tau_{n+1}$ (cf. 6.1.1.b) is also valid for $i = n+1$.

The duality functor $\Delta C^{\text{op}} \rightarrow \Delta C$ sends $[n]$ to $[n]$, d_i to $\sigma_i : [n+1] \rightarrow [n]$ for $i = 0, \dots, n+1$ (this is possible because of the existence of the extra degeneracy σ_{n+1}), s_i to $\delta_{i+1} : [n-1] \rightarrow [n]$ for $i = 0, \dots, n-1$ (note that δ_0 is not used), and t_n to $\tau_n^{-1} : [n] \rightarrow [n]$.

By using relations 6.1.1 extended as said above, it is straightforward to check that all the relations 6.1.2 are fulfilled. For instance $d_i d_j = d_{j-1} d_i$ for $i < j$ becomes $\sigma_i \sigma_j = \sigma_{j-1} \sigma_i$ for $i < j$, which is 6.1.1.a if $j < n$. If $j = n$, then $d_i d_n = d_{n-1} d_i$ becomes $\sigma_i \sigma_n = \sigma_{n-1} \sigma_i$, that is $\sigma_i \sigma_0 \tau_n^{-1} = \sigma_0 \tau_{n-1}^{-1} \sigma_i$. This is valid because $\sigma_i \sigma_0 = \sigma_0 \sigma_{i+1} = \sigma_0 \tau_{n-1}^{-1} \sigma_i \tau_n$ by 6.1.1.a and 6.1.1.b. \square

6.1.12 The ΔS -Module of an Algebra. For any unital k -algebra A there is defined a functor

$$\mathbf{C}^{\text{sym}}(A) : \Delta S \rightarrow (k\text{-Mod})$$

as follows. The image of $[n]$ is $A^{\otimes n+1}$. The action of the operators δ_i, σ_j and $g \in S_{n+1}^{\text{op}}$ (corresponding to $\bar{g} \in S_{n+1}$) are given by

$$g(a_0, \dots, a_n) = \left(a_{\bar{g}^{-1}(0)}, \dots, a_{\bar{g}^{-1}(n)} \right) ,$$

$$\delta_i(a_0, \dots, a_{n-1}) = (a_0, \dots, a_{i-1}, 1, a_i, \dots, a_{n-1}) , \text{ for } i = 0, \dots, n ,$$

$$\sigma_j(a_0, \dots, a_{n+1}) = (a_0, \dots, a_{j-1}, a_j a_{j+1}, a_{j+2}, \dots, a_{n+1}) \text{ for } j = 0, \dots, n .$$

In order to make the verifications (which are left to the reader) it is useful to remark that the action of $\phi \in \text{Hom}_\Delta([n], [m])$, considered as a non-decreasing application, is given by

$$(6.1.12.1) \quad \phi(a_0, \dots, a_n) = (b_0, \dots, b_m) ,$$

where $b_i = a_{i_1} \dots a_{i_r}$ when $\phi^{-1}(i) = \{i_1 < i_2 < \dots < i_r\}$, and $b_i = 1$ when $\phi^{-1}(i) = \emptyset$.

The composite

$$\Delta C^{\text{op}} \cong \Delta C \hookrightarrow \Delta S \xrightarrow{C^{\text{sym}}(A)} (k\text{-Mod})$$

is the cyclic module $C(A)$ (see 6.4.4).

6.1.13 Remark on the Extra Degeneracy. Note that the extra degeneracy $s_{n+1} : [n] \rightarrow [n+1]$ in ΔC^{op} is such that $d_0 s_{n+1} \neq s_n d_0$ but $d_0 s_{n+1} = t_n^{-1}$. In the case of the cyclic module $C(A)$ one has $s_{n+1}(a_0, \dots, a_n) = (1, a_0, \dots, a_n)$, so this extra degeneracy is precisely the one used in the proof of 1.1.12.

6.1.14 Automorphisms of ΔC . Remark that there are other possible formulas for an isomorphism $\Delta C \cong \Delta C^{\text{op}}$ since ΔC has non-trivial automorphisms. Indeed any sequence $\underline{i} = (i_0 = 1, i_1, \dots, i_n, \dots)$ of integers gives rise to an inner automorphism $a_{\underline{i}}$ of ΔC by the formula

$$a_{\underline{i}}(\phi) = \tau_m^{i_m} \circ \phi \circ \tau_n^{-i_n} , \quad \phi \in \text{Hom}_{\Delta C}([n], [m]) .$$

But there exists also an outer automorphism given by

$$\sigma_i \mapsto \sigma_{n-i} : [n+1] \rightarrow [n] \quad \text{for } i = 0, \dots, n ,$$

$$\delta_i \mapsto \delta_{n-i} : [n-1] \rightarrow [n] \quad \text{for } i = 0, \dots, n ,$$

$$\tau_i \mapsto \tau_{n-i} : [n] \rightarrow [n] .$$

Exercises

E.6.1.1. Let G be a group and let A and B be two subgroups of G such that any element of G can be uniquely written as a product $\phi \circ g$ with $\phi \in A$ and $g \in B$. Define functions $\phi^* : B \rightarrow B$ and $g_* : A \rightarrow A$ by the requirement

$$g \circ \phi = g_*(\phi) \circ \phi^*(g) .$$

Show that these functions satisfy the properties of 6.1.6. Show that the case $\phi^* = id$ for all ϕ corresponds to a semi-direct product $G = B \rtimes A$.

E.6.1.2. Connes' Proof of Decomposition in ΔC . Show that ΔC can be identified with the category A whose objects are $[n]$, $n \in \mathbb{N}$, and whose morphisms $f \in \text{Hom}_A([n], [m])$ are homotopy classes of monotone degree 1 maps ϕ from S^1 to itself such that $\phi(\mathbb{Z}/(n+1)\mathbb{Z}) \subset \mathbb{Z}/(m+1)\mathbb{Z}$. Here S^1 is identified with the complex numbers of module 1 and $\mathbb{Z}/n\mathbb{Z}$ with the group of n th roots of unity.

Deduce from this interpretation another proof of Theorem 6.1.3 (cf. Connes [1983]).

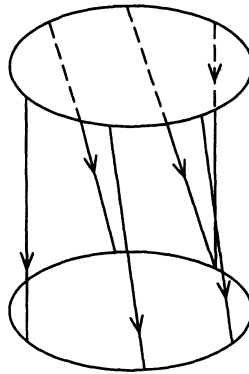

E.6.1.3. Show that the relations $d_i t_n = t_{n-1} d_{i-1}$ for $1 \leq i < n$ and $d_0 t_n = d_n$ imply $d_i (t_n)^{n+1} = (t_{n-1})^n d_i$ for all i . Show some similar implications with degeneracies.

E.6.1.4. Show that the family of modules $[n] \mapsto k[U_{n+1}] \otimes A^{\otimes n+1}$ is equipped with faces and degeneracy maps like for a simplicial module, except that the formulas $s_i s_j = s_{j+1} s_i$ are not fulfilled. (Cf. Frabetti [1997]).

E.6.1.5. Prove that all the automorphisms of ΔC are generated by those described in 6.1.14. Give the complete structure of this automorphism group. Show that the outer automorphism becomes inner for ΔD (cf. 6.3.4).

E.6.1.6. Consider a category presented by generators and relations as follows. The objects are $[n]$, $n \geq 0$, the generating morphisms are d_i, s_j, t_n and $t'_n : [n] \rightarrow [n]$. Relations are as in 6.1.2, plus relations (b) and (c) with t'_n in place of t_n , plus $t_n t'_n = t'_n t_n$. Show that, contrarily to what was expected, this category is simply ΔC . In other words show that all these relations imply $t_n = t'_n$. (This was a naive and unsuccessful attempt to discretize $S^1 \times S^1$.)

E.6.1.7. Let $\theta_k, k = 0, \dots, n - 1$ be the involution $(k\ k+1)$ in $S_{n+1} = \text{Aut}\{0, \dots, n\}$. Show that a presentation of ΔS is given by the generators $\delta_i, \sigma_j, \theta_k$ and the relations

- (a) those of Δ (cf.6.1.1.a),
- (b)
 - $\theta_k \delta_i = \delta_i \theta_k$ for $k < i - 1$,
 - $= \delta_{i-1}$ for $k = i - 1$,
 - $= \delta_{i+1}$ for $k = i$,
 - $= \delta_i \theta_{k-1}$ for $k > i$,
 - $\theta_k \sigma_j = \sigma_j \theta_k$ for $k < j - 1$,
 - $= \sigma_{j-1} \theta_j \theta_{j-1}$ for $k = j - 1$,
 - $= \sigma_{j+1} \theta_j \theta_{j+1}$ for $k = j$,
 - $= \sigma_j \theta_{k+1}$ for $k > j$,
- (c) those of S_{n+1}^{op} for $n \geq 0$.

(Cf. Clauwens [1992].)

6.2 Tor and Ext Interpretation of HH and HC

An interpretation of Hochschild homology in terms of Tor-functors of the category of A^e -modules was given in 1.1.13. In fact there is another one which involves the category of simplicial modules rather than the category of A^e -modules. It takes the form

$$HH_n(A) \cong \text{Tor}_n^{\Delta^{\text{op}}}(k, C(A)).$$

The advantage of this interpretation is its extension to the category of cyclic modules which gives a Tor-interpretation of cyclic homology:

$$HC_n(A) \cong \text{Tor}_n^{\Delta^{C^{\text{op}}}}(k, C(A)).$$

Dually Hochschild cohomology and cyclic cohomology are interpreted in terms of Ext functors:

$$HH^n(A) \cong \text{Ext}_{\Delta^{\text{op}}}^n(C(A), k), \quad HC^n(A) \cong \text{Ext}_{\Delta^{C^{\text{op}}}}^n(C(A), k).$$

6.2.1 Simplicial and Cosimplicial Modules. A simplicial module is a functor $E : \Delta^{\text{op}} \rightarrow (k\text{-Mod})$ or equivalently a contravariant functor from Δ to $(k\text{-Mod})$. A *cosimplicial module* is a functor $F : \Delta \rightarrow (k\text{-Mod})$. One can do homological algebra within the abelian category of simplicial (resp. cosimplicial) modules and so the groups $\text{Tor}_n^{\Delta^{\text{op}}}(F, E)$ are well-defined for all $n \geq 0$. They are in fact k -modules. For $n = 0$ one has

$$\mathrm{Tor}_0^{\Delta^{\mathrm{op}}}(F, E) := F \otimes_{\Delta^{\mathrm{op}}} E = E \otimes_{\Delta} F := \left(\coprod_{n \geq 0} E_n \otimes F_n \right) / \approx ,$$

where the equivalence relation \approx is generated by:

$$x \otimes \phi_*(y) \approx \phi^*(x) \otimes y$$

for any $x \in E_m$, $y \in F_n$ and $\phi \in \mathrm{Hom}_{\Delta}([n], [m])$.

When F is the *trivial functor* k given by $F([n]) = k$, for all $n \geq 0$, with faces and degeneracies given by the identity, one can relate the groups $\mathrm{Tor}_n^{\Delta^{\mathrm{op}}}(k, E)$ to the classical homology groups of the complex E_* (with differential map $\Sigma_i(-1)^i d_i$) associated to E .

6.2.2 Theorem. *For any simplicial module E there is a canonical isomorphism*

$$\mathrm{Tor}_n^{\Delta^{\mathrm{op}}}(k, E) \cong H_n(E_*) .$$

6.2.3 Corollary. *Let $E = C(A, M)$ be the simplicial module $C_n(A, M) = M \otimes A^{\otimes n}$ associated to the unital k -algebra A and the A -bimodule M . Then there is a canonical isomorphism*

$$\mathrm{Tor}_n^{\Delta^{\mathrm{op}}}(k, C(A, M)) \cong H_n(A, M) . \quad \square$$

Note that this Tor-interpretation of Hochschild homology is different from what was done in 1.1.13. In particular one does not need A to be flat over k here.

Proof of Theorem 6.2.2. The idea of the proof is to provide a particular resolution of the trivial Δ -module k . Let $\Delta_n := \mathrm{Hom}_{\Delta}([n], -)$ be the cosimplicial set such that $\Delta_n[m] = \mathrm{Hom}_{\Delta}([n], [m])$. Then $K_n = k[\Delta_n]$ (free k -module over Δ_n) is a cosimplicial module.

Define $b : K_n \rightarrow K_{n-1}$ by $b = \sum_{i=0}^n (-1)^i d_i$. Then the following is a well-defined complex of cosimplicial modules

$$K_* : \quad \dots \rightarrow K_2 \rightarrow K_1 \rightarrow K_0 \rightarrow k ,$$

where the last map is the augmentation map to the trivial cosimplicial module k .

Let us show that the complex $K_*[-]$ is a projective resolution of the trivial cosimplicial module k in the category of cosimplicial modules.

6.2.4 Lemma. For any $m \geq 0$ the complex of projective k -modules

$$\dots \rightarrow K_2[m] \rightarrow K_1[m] \rightarrow K_0[m] \rightarrow k$$

is an augmented acyclic complex.

Proof. The homology of $K_*[m]$ is the homology of the simplicial set $\Delta[m]$, whose geometric realization is the geometric m -simplex Δ^m (cf. Appendix B.6). Since Δ^m is contractible, $K_*[m]$ is acyclic. \square

End of the Proof of Theorem 6.2.2. An immediate consequence of the lemma is that we can use K_* to compute the Tor-group. This gives $\text{Tor}_n^{\Delta^{\text{op}}}(k, E) \cong H_n(E \otimes_{\Delta} K_*)$. But the map $E \otimes_{\Delta} K_n \rightarrow E_n$, which is induced by $z \otimes \phi \mapsto \phi^*(z)$ for $\phi \in \text{Hom}_{\Delta}([n], [m])$ and $z \in E_m$, is an isomorphism of k -modules. Therefore the complex $E \otimes_{\Delta} K_*$ is precisely the classical complex associated to a simplicial module. \square

6.2.5 Remark. We may wish to work with Δ instead of Δ^{op} . The same kind of property applies since it is a formality to show that

$$\text{Tor}_*^{\Delta}(E, F) = \text{Tor}_*^{\Delta^{\text{op}}}(F, E).$$

6.2.6 Ext-Interpretation of HH^* . Let E and E' be two simplicial modules. Then one can define the derived functors $\text{Ext}_{\Delta^{\text{op}}}^n(E, E')$. In particular $\text{Ext}_{\Delta^{\text{op}}}^0(E, E') = \text{Hom}_{\Delta^{\text{op}}}(E, E')$. The proof of Theorem 6.2.2 can be mimicked to show than for any k -algebra A there is a canonical isomorphism

$$\text{Ext}_{\Delta^{\text{op}}}^n(C(A), k) \cong HH^n(A).$$

6.2.7 Tor-Interpretation of Cyclic Homology. The interpretation of cyclic homology and cyclic cohomology as Tor and Ext functors respectively consists in replacing Δ by ΔC . The proof is along the same lines as for Hochschild homology, though instead of constructing a particular resolution for the trivial ΔC -module k , one constructs a *biresolution*.

6.2.8 Theorem. For any cyclic module E there is a canonical isomorphism

$$\text{Tor}_n^{\Delta C^{\text{op}}}(k, E) \cong HC_n(E).$$

In particular, for any unital k -algebra A there is a canonical isomorphism

$$\text{Tor}_n^{\Delta C^{\text{op}}}(k, C(A)) \cong HC_n(A).$$

Proof. The biresolution of the trivial cyclic module k is constructed as follows.

Let $(K_{(p,q)})_n = k[\text{Hom}_{\Delta}([q], [n])]$ (same module for all p). Then $K_{(p,q)}$ can be made into a left ΔC -module by using composition in ΔC .

Obviously $K_{(p,\cdot)}$ is a simplicial ΔC -module, therefore it defines a complex of ΔC -modules. We look at it as a vertical complex. The horizontal differential $K_{(p,q)} \rightarrow K_{(p-1,q)}$ is induced by $(1 - t_q)$ when p is odd and by $N = 1 + t_q \dots + t_q^q$ when p is even. Here t_q is the cyclic operator with sign (cf. 2.5.1).

This defines a bicomplex of ΔC -modules $K_{(\cdot,\cdot)}$.

For fixed n the bicomplex of k -modules $K_{(\cdot,\cdot)}[n]$ has columns (p fixed) which are acyclic but in dimension 0, where the homology is k . In fact the resulting horizontal complex (in dimension 0) is

$$k \xleftarrow{0} k \xleftarrow{1} k \xleftarrow{0} k \xleftarrow{1} \dots$$

and therefore the homology of the bicomplex $K_{(\cdot,\cdot)}[n]$ is k concentrated in dimension 0. This proves that $K_{(\cdot,\cdot)}$ is a biresolution of the trivial ΔC -module k .

The ΔC -module $K_{(p,q)}$ is projective because it is equal to the ideal $k[\Delta C].id_{[q]}$ and $id_{[q]}$ is an idempotent.

The computation of $\text{Tor}^{\Delta C}(E, k)$ is a consequence of the equality $E \otimes_{\Delta C} K_{(p,q)} = E_q$ and so the bicomplex $E \otimes_{\Delta C} K_{(\cdot,\cdot)}$ is precisely the cyclic bicomplex $C(E)$ described in 2.5.5. □

6.2.9 Ext-Interpretation of Cyclic Cohomology. For cyclic cohomology one gets an isomorphism

$$\text{Ext}_{\Delta C^{\text{op}}}^n(E, k) \cong HC^n(E)$$

and so for any unital k -algebra A one gets

$$\text{Ext}_{\Delta C^{\text{op}}}^n(C(A), k) \cong HC^n(A) .$$

6.3 Crossed Simplicial Groups

The notion of crossed simplicial group comes from the following natural question: are there families of groups which have the same kind of relationship with Δ as the family of cyclic groups? We have already seen in 5.2 (resp. 6.1) that the dihedral groups and the quaternionic groups (resp. the symmetric groups) are such families. The axiomatization of the properties of the category ΔC gives rise to the notion of *crossed simplicial group*. Simplicial groups are particular examples of this new structure, in fact examples for which a certain type of action is trivial, whence the choice of the adjective *crossed* for the general notion.

Apart from cyclic, dihedral, quaternionic and symmetric groups, other examples are hyperoctahedral groups and braid groups. In fact there is a classification of crossed simplicial groups in terms of simplicial groups and seven particular crossed simplicial groups (cf. 6.3.5).

Any crossed simplicial group gives rise to a theory analogous to cyclic homology, for instance dihedral and quaternionic homology. For the symmetric case and braid case the associated theories are related to the functors $\Omega^\infty S^\infty$ and $\Omega^2 S^2$ (cf. Exercise E.6.3.2).

This section is taken out from Fiedorowicz-Loday [1991].

6.3.0 Definition. A *crossed simplicial group* is a family of groups $G_n, n \geq 0$, such that there exists a category ΔG with objects $[n], n \geq 0$, containing Δ as a subcategory and such that

- (1) the group of automorphisms of $[n]$ in ΔG is the (opposite) group G_n^{op} ,
- (2) any morphism from $[n]$ to $[m]$ in ΔG can be uniquely written as the composite $\phi \circ g$ with $\phi \in \text{Hom}_\Delta([n], [m])$ and $g \in \text{Aut}_{\Delta G}([n]) = G_n^{\text{op}}$.

6.3.1 Lemma. *The family of groups $G_\cdot = \{G_n\}$ form a simplicial set and even a ΔG^{op} -set.*

Proof. Once G_n is identified with $\text{Aut}_{\Delta G^{\text{op}}}([n])$, the proof is the same as in Proposition 6.1.9. □

Remark that in general G_\cdot is not a simplicial group, example: \mathbf{C} (there is no non-trivial group homomorphism from $\mathbb{Z}/n\mathbb{Z}$ to $\mathbb{Z}/(n+1)\mathbb{Z}$). On the other hand it is interesting to know when a simplicial set which has a group structure in each dimension is a crossed simplicial group.

6.3.2 Proposition. *A crossed simplicial group is a simplicial set G_\cdot such that each G_n is equipped with*

- a group structure,
- an action (on the right) on $\text{Hom}_\Delta([m], [n])$ for all m , such that the formulas of Proposition 6.1.6 are fulfilled. □

6.3.3 Examples. Let H_n be the *hyperoctahedral group*, that is the semi-direct product of the symmetric group S_n with $(\mathbb{Z}/2\mathbb{Z})^n$, where the symmetric group acts by permutation of the factors: $H_n := (\mathbb{Z}/2\mathbb{Z})^n \rtimes S_n$. The quotient map is denoted by $\pi : H_n \rightarrow S_n$. The dihedral group $D_n = \{\tau, \omega \mid \tau^n = \omega^2 = 1, \omega\tau\omega^{-1} = \tau^{-1}\} = \mathbb{Z}/2\mathbb{Z} \rtimes \mathbb{Z}/n\mathbb{Z}$ can be identified to a subgroup of H_n by sending $\mathbb{Z}/2\mathbb{Z}$ diagonally to $(\mathbb{Z}/2\mathbb{Z})^n$ and τ to the cyclic permutation $(1\ 2 \dots n)$. The quaternionic group $Q_n = \{\tau, \omega \mid \tau^n = \omega^2, \omega\tau\omega^{-1} = \tau^{-1}\}$ is the 2-fold non-trivial central extension of D_n .

6.3.4 Proposition. *The following families of groups are crossed simplicial groups:*

- (a) any simplicial group,
- and also the following, which are not simplicial groups (except $\{1\}$):

- (b) the seven “fundamental crossed simplicial groups” that is the family of hyperoctahedral groups $\{H_{n+1}\}$, and the following subfamilies: $\{\mathbb{Z}/2\mathbb{Z} \times S_{n+1}\}$, $\{S_{n+1}\}$, $\{D_{n+1}\}$, $\{\mathbb{Z}/(n+1)\mathbb{Z}\}$, $\{\mathbb{Z}/2\mathbb{Z}\}$, $\{1\}$,
- (c) the family $\{\mathbb{Z}\}$,
- (d) for any fixed integer r the family of cyclic groups $(C(r))_n = \{\mathbb{Z}/r(n+1)\mathbb{Z}\}$,
- (e) the family of quaternionic groups $\{Q_{n+1}\}$,
- (f) the family of braid groups $\{B_{n+1}\}$.

Proof. (a) By Proposition 6.3.2 we only need to provide a right action of G_n on $\text{Hom}_\Delta([m], [n])$ or equivalently a left action of G_n^{op} . Let this action be trivial, that is $g^*(\phi) = \phi$ for any $g \in G_n^{\text{op}}$ and any $\phi \in \text{Hom}_\Delta$. Then formulas of Proposition 6.1.6 are obviously fulfilled. Note that, vice-versa, a crossed simplicial group for which G_n acts trivially is a simplicial group.

- (b) The proof is similar to the one provided for ΔS by Theorem 6.1.4 but with the following modifications concerning Lemma 6.1.5. Write $g = (g_0, \dots, g_n; \pi(g))$, $g_i \in \mathbb{Z}/2\mathbb{Z}$ and $\pi(g) \in S_{n+1}^{\text{op}}$, for an element of H_{n+1}^{op} . In Lemma 6.1.5
 - put H in place of S ,
 - in the diagram of (i) replace the vertical maps by $\pi(\phi^*(g))$ and $\pi(g)$ respectively,
 - condition (ii) is: the restriction of $\pi(\phi^*(g))$ to the subset $(\phi)^{-1}(i)$ preserves (resp. inverts) the order if $g_{\pi(g)(j)} = 0$ (resp. 1),
 - there is one more condition: (iii) $(\phi^*(g))_i = g_{\phi(i)}$.

Note that the action of H_{n+1} on $\text{Hom}_\Delta([m], [n])$ is via the canonical projection π . This ends the proof of the hyperoctahedral case.

Then it is straightforward to check that all the other families are stable under the simplicial structure. The last case was listed for completeness of the subfamilies of H . Remark that $\{\mathbb{Z}/2\mathbb{Z}\}$ is not the trivial simplicial group, in fact it is not even a simplicial group.

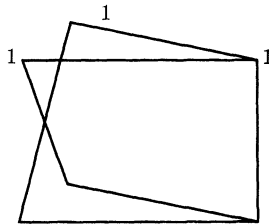

For cases (c), (d) and (e) we describe the presentation of ΔG . (For case (f) see Exercise E.6.3.1). The proof consists in providing another crossed simplicial group G'' , which is one of the seven fundamental crossed simplicial groups, and a simplicial group G' together with maps

$$1 \rightarrow G' \rightarrow G \rightarrow G'' \rightarrow 1$$

which form extensions of groups in all dimensions. The uniqueness property (2) of 6.3.0 follows from the uniqueness property for G'' and G' .

- (c) The category $\Delta\mathbb{Z}$ has a presentation by generators and relations like in 6.1.1 but with condition (c) replaced by: τ_n is an isomorphism. Remark that now the relations $\tau_n\delta_0 = \delta_n$ and $\sigma_0 = \sigma_n\tau_{n+1}^2$ are not consequences of the others anymore. Here $G'' = \mathbb{C}$ and G' is the trivial simplicial group \mathbb{Z} (cf. Exercise E.6.1.3).
- (d) The category $\Delta C(r)$ has a presentation by generators and relations like in 6.1.1 but with condition (c) replaced by $(\tau_n)^{r(n+1)} = 1$. Here $G'' = \mathbb{C}$ and G' is the trivial simplicial group $\mathbb{Z}/r\mathbb{Z}$ (again cf. Exercise E.6.1.3).
- (e) The category ΔQ has for generators those of Δ and those of Q_n for all n . The relations are:
 - those of Δ ,
 - $\tau_n\delta_i = \delta_{i-1}\tau_{n-1}$, for $1 \leq i \leq n$, $\tau_n\delta_0 = \delta_n$,
 - $\omega_n\delta_i = \delta_{n-i}\omega_{n-1}$, for $0 \leq i \leq n$,
 - $\tau_n\sigma_i = \sigma_{i-1}\tau_{n+1}$, for $1 \leq i \leq n$,
 - $\omega_n\delta_i = \delta_{n-i}\omega_{n+1}$, for $0 \leq i \leq n$,
 - those of Q_n for all n .

Remark that if one adds the relation $\omega^2 = 1$, then one gets a presentation of the dihedral crossed simplicial group. Here $G'' = \{D_{n+1}\}$ and G' is the trivial simplicial group $\mathbb{Z}/2\mathbb{Z}$. □

6.3.5 Classification of Crossed Simplicial Groups. The case (b) of the preceding proposition is important in view of the following classification theorem:

Any crossed simplicial group G is an extension of G' by G'' , where G' is a simplicial group and G'' is one of the seven fundamental crossed simplicial groups (see 6.3.4.b),

$$1 \rightarrow G' \rightarrow G \rightarrow G'' \rightarrow 1 .$$

Since we will not use this result in the book we refer to the literature for the proof (cf. Fiedorowicz-Loday [1991]).

6.3.6 ΔG^{op} -Objects. Mimicking what was done for simplicial modules and cyclic modules one can define ΔG^{op} -modules and a homology theory attached to them (see 6.3.7 below). More generally a ΔG^{op} -object in a category \mathcal{C} is simply a functor

$$X : \Delta G^{\text{op}} \rightarrow \mathcal{C} .$$

We already noted in 6.3.1 that $[n] \mapsto G_n$ is a ΔG^{op} -set. For any $a \in \text{Hom}_{\Delta G^{\text{op}}}([m], [n])$ and any $g \in G_m$ the element $a_*(g)$ is defined by the following equality of morphisms in ΔG^{op} ,

$$a \circ g = a_*(g) \circ g^*(a) , \quad a_*(g) \in G_n , \quad g^*(a) \in \text{Hom}_{\Delta G^{\text{op}}}([m], [n]) .$$

The classifying space of this simplicial set is a topological group which plays an important role in the theory. The particular case $\Delta G = \Delta C$ will be studied in detail in the next chapter, in a way which easily allows its generalization to any crossed simplicial group (mutatis mutandis).

Let us indicate what the geometric realizations are in a few cases:

$$|C_\bullet| = S^1, |D_\bullet| = O(2), |Q_\bullet| = Pin(2) \text{ (normalizer of } S^1 \text{ in } S^3), |\{Z\}_\bullet| = \mathbb{R}, |\{Z/2Z\}_\bullet| = Z/2Z, |S_\bullet| = S^\infty = \lim_n S^n, |H_\bullet| = Z/2Z \times S^\infty.$$

6.3.7 Homology and Cohomology Theories Associated to Crossed Simplicial Groups. Let G_\bullet be a crossed simplicial group with associated category ΔG . Any functor $E : \Delta G^{op} \rightarrow (k\text{-Mod})$ gives rise to a homology theory $Tor_*^{\Delta G^{op}}(k, E)$. We know by 6.2.3 and 6.2.8 that for $G = \{1\}$ and $G = \mathbf{C}$ these homology groups can be computed via the Hochschild complex and cyclic bicomplex respectively.

In the dihedral case, and under the assumption $1/2 \in k$, we constructed in Sect. 5.2 a bicomplex CC^+ giving rise to dihedral homology HD_* . The same proof as in 6.2.8 shows that for any dihedral module E , there is a canonical isomorphism

$$Tor_n^{\Delta D^{op}}(k, E) \cong HD_n(E).$$

If 2 is not invertible in k , then one can either work with quaternionic homology (cf. 5.2.13) to get an isomorphism (for any quaternionic module):

$$Tor_n^{\Delta Q^{op}}(k, E) \cong HQ_n(E).$$

or, if one still wants to use $Tor_n^{\Delta D^{op}}$, then take as HD the theory due to J. Lodder and defined in Exercise E.5.2.4.

Of course similar isomorphisms hold in cohomology by using the Ext functors.

For the categories ΔS^{op} , ΔH^{op} and ΔB^{op} (see Exercise E.6.3.1) the associated homology theory is simply Hochschild homology, see Exercise E.6.3.2. For the category ΔC we still recover cyclic homology since ΔC is isomorphic to ΔC^{op} . However for the category ΔS we get another theory that Fiedorowicz showed to be strongly related to the functor $\Omega^\infty S^\infty$ (cf. Exercise E.7.3.8).

6.3.8 Generalization. One can view a crossed simplicial group, more precisely the category ΔG , as a particular case of the following situation: there is given a category \mathcal{C} with two subcategories \mathcal{A} and \mathcal{B} having the same objects as \mathcal{C} with the property that any morphism f in \mathcal{C} can be uniquely written as a composite $f = a \circ b$ with $a \in \text{Mor } \mathcal{A}$ and $b \in \text{Mor } \mathcal{B}$. The consequence of this feature is that for any \mathcal{C} -module X there is a spectral sequence abutting to $Tor_*^{\mathcal{C}}(k, X)$. A simple example of such a category (with only one object) is given in Exercise E.6.1.1. When, in this example, the action of A on B is trivial so that $G = A \rtimes B$, the spectral sequence is the Hochschild-Serre spectral sequence. Crossed simplicial groups are examples in which $\mathcal{A} = \Delta$

and \mathcal{B} is a groupoid. The epicyclic category (cf. Exercise E.6.4.3) is a slight generalization consisting in replacing the product of \mathcal{A} and \mathcal{B} by an abelian amalgamated product.

Exercises

E.6.3.1. Braid Groups. Show that the family of braid groups $\{B_{n+1}\}$ form a crossed simplicial group and identify the components G' and G'' of the decomposition (cf. 6.3.5). ($G'' = \{S_{n+1}\}_{n \geq 0}$ and G' is the simplicial group of coloured braids, cf. Fiedorowicz-Loday [1991].)

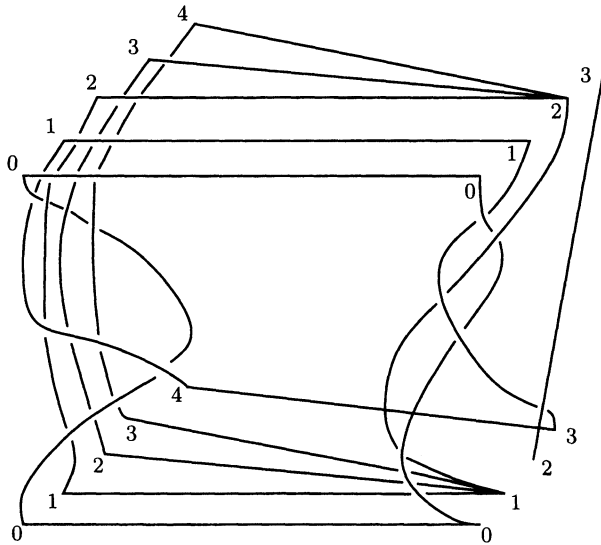

E.6.3.2. Show that if G is the crossed simplicial group $\{\mathbb{Z}\}$ described in 6.3.4.c or $\{S_{n+1}\}_{n \geq 0}$, or $\{B_{n+1}\}_{n \geq 0}$, or $\{H_{n+1}\}_{n \geq 0}$, then one has

$$\text{Tor}_n^{\Delta G^{\text{op}}}(k, E) \cong \text{Tor}_n^{\Delta \mathbb{Z}^{\text{op}}}(k, E) \cong H_n(E),$$

for any functor $E : \Delta G^{\text{op}} \rightarrow (k\text{-Mod})$. (In all these examples there are inclusions $G_n \hookrightarrow G_{n+1}$ which can be used to construct a homotopy. cf. Fiedorowicz-Loday [1991].)

E.6.3.3. Denote by $\Delta\mathbb{Z}$ the category associated to the crossed simplicial group of 6.3.4.c. Let $E : \Delta\mathbb{Z}^{\text{op}} \rightarrow (k\text{-Mod})$ be a functor. Show that using a free resolution of the infinite cyclic group one can construct a bicomplex analogous to the cyclic bicomplex. Show that it is the first two columns of the cyclic bicomplex (except that t is an infinite cyclic operator instead of being a finite cyclic one). Recover the statement of Exercise E.6.3.2 for $G = \{\mathbb{Z}\}$. Note that if we ignore the degeneracies, this statement is no more valid. (Use the resolution $0 \rightarrow \mathbb{Z}[t, t^{-1}] \xrightarrow{1-t} \mathbb{Z}[t, t^{-1}] \rightarrow \mathbb{Z}$.)

E.6.3.4. Let G be a simplicial group with associated category ΔG . Then $|G|$ is a topological group. Show that there is a homotopy equivalence

$$B|G| \xrightarrow{\sim} B\Delta G .$$

E.6.3.5. Generalize 6.1.12 to involutive algebras by replacing ΔC by ΔD and ΔS by ΔH .

6.4 The Category of Finite Sets and the λ -Decomposition

In Chap. 4 we proved that if A is commutative, then the cyclic module $C(A)$ is equipped with λ -operations. Moreover if k contains \mathbb{Q} , then these λ -operations give rise to the Eulerian idempotents which split both Hochschild homology and cyclic homology. Suppose now that one deals with a general simplicial or cyclic module. Under what conditions do there exist λ -operations on its homology or on its cyclic homology? The answer is surprisingly simple: for a simplicial module it suffices that the functor $E : \Delta^{\text{op}} \rightarrow (k\text{-Mod})$ factors through the category of finite pointed sets; for a cyclic module it suffices that the functor $E : \Delta C^{\text{op}} \rightarrow (k\text{-Mod})$ factors through the category of finite sets. Of course this is what happens for $C(A)$ when A is commutative.

The main reference for this section is Loday [1989].

6.4.1 The Category Fin of Finite Sets. Let $[n] = \{0, 1, \dots, n\}$ be a set with $n + 1$ elements, base-pointed at 0 if necessary. The *category of finite sets*, denoted **Fin**, has for objects the elements $[n]$, $n \geq 0$, and for morphisms from $[n]$ to $[m]$ all the possible set maps between $\{0, 1, \dots, n\}$ and $\{0, 1, \dots, m\}$. The *category of finite pointed sets*, denoted **Fin'**, is the subcategory of **Fin** with the same objects and with morphisms the pointed maps (i.e. $f(0) = 0$). Of course composition in these categories is just the usual composition of maps.

6.4.2 Functorial Interpretation of C. The cyclic set **C** is a functor $\Delta C^{\text{op}} \rightarrow (\text{Sets})$. Since $C_n = \mathbb{Z}/(n + 1)\mathbb{Z} = \{0, 1, \dots, n\} = [n]$ it is clear that one can consider it as a functor

$$C : \Delta C^{\text{op}} \rightarrow \mathbf{Fin} .$$

Explicitly the image of $d_i : [n] \rightarrow [n - 1]$ is given by

$$C(d_i)(j) = \begin{cases} j & \text{if } j \leq i , \\ j - 1 & \text{if } j > i , \end{cases} \quad \text{for } 0 \leq i < n ,$$

$$C(d_n)(j) = \begin{cases} j & \text{if } j < n , \\ 0 & \text{if } j = n . \end{cases}$$

the image of $s_i : [n] \rightarrow [n + 1]$ is given by

$$C(s_i)(j) = \begin{cases} j & \text{if } j \leq i, \\ j + 1 & \text{if } j > i, \end{cases} \text{ for } 0 \leq i \leq n.$$

and the image of $t_n : [n] \rightarrow [n]$ is given by

$$C(t_n)(j) = j + 1, \quad 0 \leq j < n, \quad \text{and } C(t_n)(n) = 0.$$

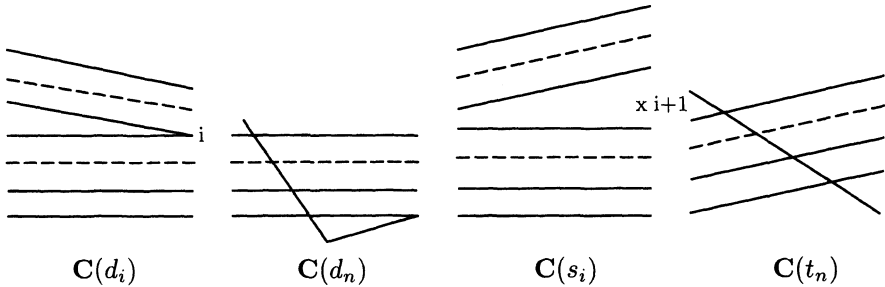

Note that the image of the morphisms of Δ^{op} are base-point preserving. Therefore there is a commutative diagram

$$\begin{array}{ccc} \Delta^{op} & \xrightarrow{C} & \mathbf{Fin}' \\ \downarrow & & \downarrow \\ \Delta C^{op} & \xrightarrow{C} & \mathbf{Fin}. \end{array}$$

6.4.3 Remark. It is classical to think of Δ as the sub-category of \mathbf{Fin}' of non-decreasing maps. The functor C relates the opposite category Δ^{op} to \mathbf{Fin}' and so is completely different. In particular the images of d_0 and $d_1 : [1] \rightarrow [0]$ in Δ^{op} are equal in \mathbf{Fin}' . However we propose to the reader to check that the composite

$$\Delta \hookrightarrow \Delta C \cong \Delta C^{op} \xrightarrow{C} \mathbf{Fin},$$

where the duality isomorphism is the one described in 6.1.11, is the classical inclusion.

Note that the composite functor from ΔC to \mathbf{Fin} factors through ΔS (cf. 6.1.12), but C does not factor through ΔS^{op} .

Our favorite example fits into this framework as follows.

6.4.4 Proposition. *Let A be a unital k -algebra and M an A -bimodule. The functor $C(A, M) : \Delta^{op} \rightarrow (k\text{-Mod})$ given by $C(A, M)[n] = M \otimes A^{\otimes n}$ factors through \mathbf{Fin}' if and only if A is commutative and M is a symmetric bimodule. If A is commutative, then the cyclic functor $C(A) : \Delta C^{op} \rightarrow (k\text{-Mod})$ factors through the category \mathbf{Fin} .*

Proof. The “only if” statement is easy since for $d_0, d_1 : [1] \rightarrow [0]$ one has $\mathbf{C}(d_0) = \mathbf{C}(d_1)$. In the opposite direction let us define functors $\mathbf{Fin}' \rightarrow (k\text{-Mod})$ and $\mathbf{Fin} \rightarrow (k\text{-Mod})$ as follows. On objects one takes $[n] \mapsto M \otimes A^{\otimes n}$ (resp. $A^{\otimes n+1}$) and on morphisms $f : [n] \longrightarrow [m]$ in \mathbf{Fin} is sent to $f_* : M \otimes A^{\otimes n} \rightarrow M \otimes A^{\otimes m}$ given by

$$f_*(a_0, \dots, a_n) = (b_0, \dots, b_m),$$

where $b_i = a_{i_1} a_{i_2} \dots a_{i_r}$ if $f^{-1}(i) = \{i_1, i_2, \dots, i_r\}$ and $b_i = 1$ if $f^{-1}(i) = \emptyset$. This is a well-defined functor whose composite with \mathbf{C} is precisely $C(A, M)$ in the \mathbf{Fin}' -case and $C(A)$ in the \mathbf{Fin} -case. \square

The point about the category \mathbf{Fin}' is that it contains faces, degeneracies (in fact images of these elements) but also the symmetric groups since $\text{Aut}_{\mathbf{Fin}'}([n]) = S_n$ (note that $\text{Aut}_{\mathbf{Fin}}([n]) = S_{n+1}$). Therefore any \mathbf{Fin}' -module gives rise to a simplicial module equipped with an action of $k[S_n]$ on the n -skeleton. So one can perform the shuffle operations, the λ -operations, etc. In fact all what we did in Sects. 5 and 6 of Chap. 4 is applicable to \mathbf{Fin}' -modules and \mathbf{Fin} -modules respectively. We just state the decomposition theorem.

6.4.5 Theorem. *Let E be a \mathbf{Fin}' -module or more generally a \mathbf{Fin} -module. Then E gives rise to a simplicial module and in the more general case to a cyclic module, which admit λ -operations on their homology. Moreover, if k contains \mathbb{Q} , these λ -operations induce λ -decompositions,*

$$H_n(E_*) = H_n^{(1)}(E_*) \oplus \dots \oplus H_n^{(n)}(E_*),$$

$$HC_n(E_*) = HC_n^{(1)}(E_*) \oplus \dots \oplus HC_n^{(n)}(E_*), \quad \text{for } n \geq 1. \quad \square$$

6.4.6 Remark. Any group G gives rise to a group algebra $k[G]$. Similarly any small category \mathcal{C} gives rise to an algebra, denoted $k[\mathcal{C}]$, whose underlying k -module is free on the set of all morphisms of \mathcal{C} . The product of two such morphisms of \mathcal{C} is their composite if they are composable, and 0 otherwise.

In the particular case of the category \mathbf{Fin} the algebra $k[\mathbf{Fin}]$ contains all the algebras $k[S_n]$, $n \geq 0$, and also the maps b and B (one for each integer n). As a result, formulas like

$$b^2 = B^2 = bB + Bb = 0,$$

$$be_n^{(i)} = e_{n-1}^{(i)} b,$$

$$Be_n^{(i)} = e_{n+1}^{(i+1)} B,$$

can be viewed as taking place in the algebra $k[\mathbf{Fin}]$.

Exercises

E.6.4.1. Let $\Delta^{\text{op}}S'$ be the subcategory of ΔS made of the morphisms γ such that, at the set level, $\gamma^{-1}(0)$ contains 0. Show that $\Delta^{\text{op}}S'$ fits into the following commutative diagram of functors which are the identity on objects,

$$\begin{array}{ccccc}
 \Delta^{\text{op}} & \hookrightarrow & \Delta^{\text{op}}S' & \longrightarrow & \mathbf{Fin}' \\
 \downarrow & & \downarrow & & \downarrow \\
 \Delta C^{\text{op}} & & & & \\
 \cong \downarrow & \hookrightarrow & \downarrow & \longrightarrow & \downarrow \\
 \Delta C & \hookrightarrow & \Delta S & \longrightarrow & \mathbf{Fin},
 \end{array}$$

where the composite from ΔC^{op} to \mathbf{Fin} is \mathbf{C} . Show that for any unital k -algebra A and any A -bimodule M the simplicial module $C(A, M)$ can be extended to a functor $\Delta^{\text{op}}S' \rightarrow (k\text{-Mod})$ (compare with 6.4.4).

E.6.4.2. Let X be a space. Show that the assignment $[n] \mapsto X^{n+1}$ (cartesian product of $n + 1$ copies of X) and $f^*(x_0, \dots, x_n) = (x_{f(0)}, \dots, x_{f(n)})$ for $f : \{0, \dots, m\} \rightarrow \{0, \dots, n\}$, defines a functor

$$X^\# : \mathbf{Fin}^{\text{op}} \rightarrow (\mathbf{Spaces}).$$

By composing with the functors $\Delta \rightarrow \Delta C \rightarrow \mathbf{Fin}^{\text{op}}$ (cf. 6.4.2) we get a cocyclic space and a cosimplicial space. Show that the geometric realization of this cosimplicial space is homotopy equivalent to the free loop space $\text{Map}(S^1, X)$. (See J.D.S. Jones [1987].)

E.6.4.3. Barycentric Subdivision Functor. Consider Δ as the category of non-decreasing maps (cf. Appendix B.1). The barycentric subdivision functor $sd_p : \Delta \rightarrow \Delta$ sends $[n - 1]$ to $[pn - 1]$ and a map f to the concatenation $f \perp f \perp \dots \perp f$ (p times):

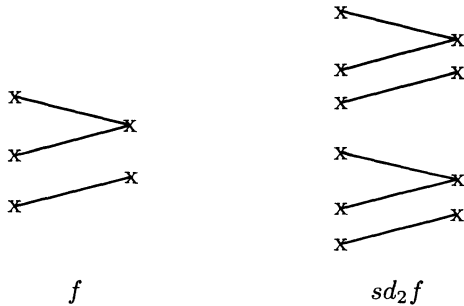

For any simplicial object X , we define a new simplicial object $sd_p X := X \circ sd_p$. Use the fact that the geometric simplex Δ^{pn-1} is the p -fold join $\Delta^{n-1} * \dots * \Delta^{n-1}$ to show that there is a canonical homeomorphism $|sd_p X| \cong |X|$ for any simplicial space X (the cellular structure of $|sd_p X|$ is a partial barycentric subdivision of $|X|$):

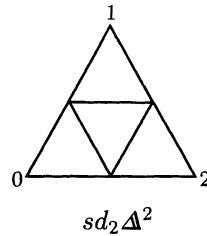
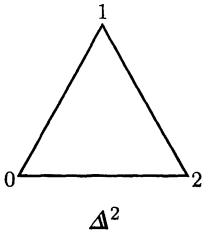

Analogously, show that for any simplicial module C , there is a canonical quasi-isomorphism $(sd_p C)_* \rightarrow C_*$ (Goodwillie [unpublished], Grayson [1992], Bökstedt-Hsiang-Madsen [1992]).

E.6.4.4. The Epicyclic Category $\Delta\Psi$. Endow ΔC with new operators $\pi_{n-1}^p : [pn - 1] \rightarrow [n - 1]$, $p, n \in \mathbb{N}$, with the relations

$$(1) \quad \pi_{n-1}^1 = id ,$$

$$(2) \quad \pi_{n-1}^p \pi_{pn-1}^q = \pi_{n-1}^{pq} ,$$

$$(3) \quad \alpha \pi_m^p = \pi_n^p sd_p(\alpha) \quad \text{for } \alpha \in \text{Hom}_{\Delta C}([m], [n]) ,$$

where $sd_p(\alpha)$ is as above for $\alpha \in \text{Hom}_{\Delta}$ and $sd_p(\tau_{n-1}) = \tau_{pn-1}$. Show that this new category $\Delta\Psi$ (called by Goodwillie the *epicyclic category*) is a discretization of the monoid $S^1 \rtimes \mathbb{N}$ where $n \in \mathbb{N}$ is acting on S^1 by the power map $z \mapsto z^n$. Show that there is a factorization of $\Delta C \rightarrow \mathbf{Fin}$ (see Exercise E.6.4.1) through $\Delta\Psi$. (Constructed by Goodwillie [unpublished] this category is studied in Burghlea-Fiedorowicz-Gajda [1991].)

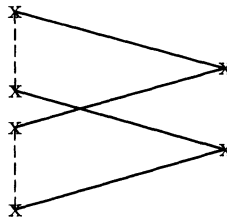

Image of π_n^2 in \mathbf{Fin}

E.6.4.5. Let $E : \Delta\Psi^{\text{op}} \rightarrow (k\text{-Mod})$ be a functor and still denote by E its restriction to ΔC^{op} . Show that there exist operations Ψ^p on $HC_*(E)$ such that $\Psi^p \Psi^q = \Psi^{pq}$. Show that, if E factors through \mathbf{Fin} , then these operations are the Adams operations described in Theorem 6.4.5.

Bibliographical Comments on Chapter 6

The idea of the cyclic category grew from the feeling of Alain Connes that it should be possible to interpret cyclic cohomology in terms of derived functors. He succeeded perfectly well in this task and his results appeared in [1983], where he describes ΔC (denoted A or ΔK in loc.cit.). This note contains the interpretation of cyclic cohomology in terms of an Ext-functor, the duality property of ΔC and the proof of the homotopy equivalence between $B\Delta C$ and BS^1 . It was the starting point of many studies on cyclic objects.

The extension of these results to the dihedral and quaternionic case is done in Loday [1987], see also Krasauskas-Lapin-Solovev [1987]. It is used in several places, Dunn [1989], Lodder [1990, 1992].

The extension to crossed simplicial groups was done in 1985 by Fiedorowicz and Loday and appeared finally in [1991]. A similar treatment appeared independently in Krasauskas [1987]. The category ΔB should be the relevant category to look at, when dealing with “braided categories” appearing in the quantum group theory.

The relationship with λ -operations and the category of finite sets was done in Loday [1989] and subsequent work can be found in Burghilea-Fiedorowicz-Gajda [1991, 1992]. Some of the relations intertwining the symmetric group and the category Δ appeared in Feigin-Tsygan [FT]. For the relationship between the λ -operations and the subdivision functor sd_r see McCarthy [1992b].

Chapter 7. Cyclic Spaces and S^1 -Equivariant Homology

There are several ways of constructing simplicial models for the circle S^1 . The simplest one consists in taking only two non-degenerate cells: one in dimension 0 and one in dimension 1. Another model consists in taking the nerve of the infinite cyclic group \mathbb{Z} . Then its geometric realization has many cells. A priori this latter version, though more complicated in terms of cell decomposition, has the advantage of taking care of the group structure of $S^1 \cong B\mathbb{Z} = |B\mathbb{Z}|$ because the nerve $B\mathbb{Z}$ of \mathbb{Z} is a simplicial group. The main point about the cyclic setting is that in the 2-non-degenerate cell decomposition of S^1 there is a way of keeping track of its group structure. Indeed the corresponding simplicial set has $n + 1$ simplices in dimension n and there is a canonical identification with the elements of the cyclic group $\mathbb{Z}/(n + 1)\mathbb{Z}$. Then one can recover the group structure on the geometric realization S^1 from the group structure of the cyclic groups.

It is *this* model which gives rise to cyclic spaces and so to a nice simplicial version of S^1 -spaces.

The main result of this chapter reads as follows: – the geometric realization of the underlying simplicial space of a cyclic space is naturally equipped with an action of the topological group $S^1 (= SO(2))$.

Moreover any S^1 -(compactly generated) space can be obtained that way. Therefore the study of S^1 -spaces can be reduced to the study of a family of $\mathbb{Z}/(n + 1)\mathbb{Z}$ -spaces (for all $n \geq 0$ at once), that is to *discrete* group actions. One of the examples of spaces which arise from cyclic sets is the free loop space. We study in detail the case of the free loop space over BG .

Section 7.1 is devoted to the S^1 -structure of the geometric realization of a cyclic space.

Then in Sect. 7.2 we show how cyclic homology is related to the S^1 -equivariant homology. More precisely any cyclic set X gives rise to a cyclic module $k[X]$ and so to cyclic homology groups $HC_*(k[X])$. On the other hand, since the geometric realization $|X|$ is an S^1 -space, its S^1 -equivariant homology groups $H_*^{S^1}(|X|, k)$ is well-defined. The main theorem asserts that these two theories are canonically isomorphic:

$$HC_*(k[X]) \cong H_*^{S^1}(|X|, k).$$

Some examples, essentially based on groups, are treated in Sect. 7.3. One of them yields the free loop space with its standard S^1 -structure.

Section 7.4 is devoted to the computation of HH and HC of group algebras. We put this section here instead of putting it in Chap. 3 because we use the examples of the preceding section.

Standard Assumption. By *simplicial space* we always mean “good” simplicial space in the sense of G. Segal [1974]. This ensures that any simplicial map $X_n \rightarrow X'_n$, $n \geq 0$, which is a homotopy equivalence for all n , induces a homotopy equivalence on the geometric realization (cf. Appendix B.8).

As usual k is a commutative ring.

7.1 Cyclic Sets and Cyclic Spaces

A cyclic set is a simplicial set equipped in each dimension with an action of the corresponding finite cyclic group. These actions are compatible, in a certain sense, with the simplicial structure. The main point of this section is to show that on the geometric realization the cyclic structure induces an action of the topological group $SO(2) = S^1$. This property is easily extended to cyclic spaces. Examples are discussed in the next section. The only part of the previous chapter which is needed here is the structure of the cyclic category, that is Sect. 6.1. The proofs are written in such a way that they extend word for word to any crossed simplicial group.

7.1.1 Definitions. A *cyclic set* is a functor $X : \Delta C^{\text{op}} \rightarrow (\mathbf{Sets})$. So, explicitly, a cyclic set is a collection of sets X_n , $n \geq 0$, with faces $d_i : X_n \rightarrow X_{n-1}$, $0 \leq i \leq n$, degeneracies $s_i : X_n \rightarrow X_{n+1}$, $0 \leq i \leq n$, and cyclic operators $t_n : X_n \rightarrow X_n$ which verify the relations (a)-(b)-(c) of 6.1.2. By ignoring the cyclic operators we are left with a simplicial set which is still denoted by X , or simply X .

A *cyclic space* is a functor $X : \Delta C^{\text{op}} \rightarrow (\mathbf{Spaces})$ which is good as a simplicial space (see convention above). Of course a cyclic set is a particular cyclic space.

Similarly a *cocyclic set* (resp. *cocyclic space*) is a functor $\Delta C \rightarrow (\mathbf{Sets})$ (resp. $\Delta C \rightarrow (\mathbf{Spaces})$) which is good as a cosimplicial space). Remark that by the duality property 6.1.11 any cocyclic object determines uniquely a cyclic object and conversely.

We already noted in 6.1.9 that \mathbf{C} is a cyclic set (see below). More examples will be dealt with in the next sections.

7.1.2 The Circle and \mathbf{C} . The simplest simplicial set whose geometric realization is the circle $S^1 = \mathbb{R}/\mathbb{Z}$ has two non-degenerate cells: one in dimension 0, denoted $*$ (the base-point), and one in dimension 1, denoted t . It is immediate to see that this simplicial set is precisely \mathbf{C} , described in 6.1.9 via the bijection

$(s_0)^n(*) \mapsto 1 = t_n^0$, and $s_{n-1}s_{n-2} \dots \widehat{s_i} \dots s_0(t) \mapsto t_n^{i+1}$ for $i = 0, \dots, n$.

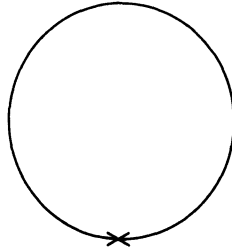

Its cyclic structure was made explicit in 6.1.10.

7.1.3 The Cocyclic Space Δ^\cdot . The family of standard simplices Δ^n , $n \geq 0$, assembles to give a cosimplicial space Δ^\cdot . For instance $\delta_i : \Delta^{n-1} \rightarrow \Delta^n$ is the identification of Δ^{n-1} with the face of Δ^n opposite to the vertex i .

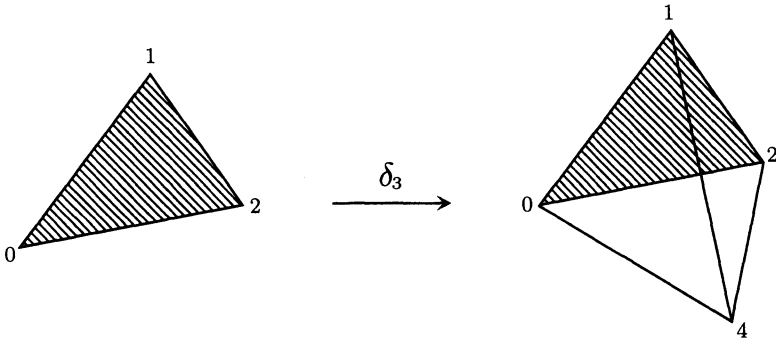

Let $\tau_n : \Delta^n \rightarrow \Delta^n$ be the linear homeomorphism which sends the vertex i to the vertex $i - 1$, $1 \leq i \leq n$, and the vertex 0 to the vertex n . It is straightforward to check that this endows Δ^\cdot with a structure of cyclic space (cf. 7.1.1), see figure on the next page.

Note that for $n = 1$, $\tau_1 : [0, 1] \rightarrow [0, 1]$ is given by $u \mapsto 1 - u$.

The main result of this section is the following

7.1.4 Theorem. *Let X be a cyclic space and let $|X|$ be the geometric realization of its underlying simplicial space.*

- (i) $|X|$ is endowed with a canonical action of the circle S^1 ,
- (ii) $X \mapsto |X|$ is a functor from (Cyclic spaces) to (S^1 -spaces).

The naive idea would be to look at the map $\mathbf{C} \times X \rightarrow X$, $(g, x) \mapsto g_*(x)$. However this map is not simplicial, so we need to introduce a new simplicial

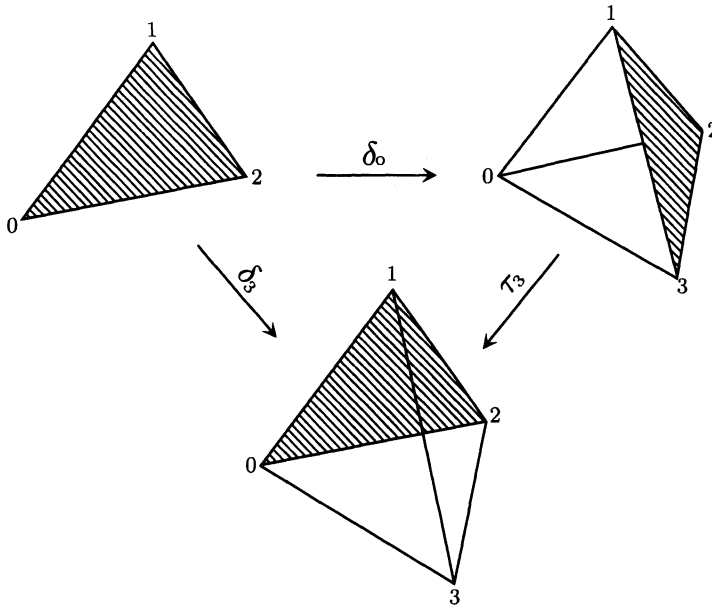

set $F(X)$. It will have the same geometric realization as $\mathbf{C} \times X$, and will be equipped with a natural map to X .

7.1.5 The Adjoint Functor F . The forgetful functor from cyclic spaces to simplicial spaces admits a left adjoint functor $F: (\mathbf{Simplicial\ spaces}) \rightarrow (\mathbf{Cyclic\ spaces})$ which is described as follows.

Recall from 6.1.8 that any element $g \in \mathbf{C}_n$ determines an endomorphism g^* of $\text{Hom}_{\Delta^{\text{op}}}([m], [n])$ and any $f \in \text{Hom}_{\Delta^{\text{op}}}([m], [n])$ determines a map f_* from \mathbf{C}_n to \mathbf{C}_m (simplicial structure of \mathbf{C}).

Let Y be a simplicial space and let $F(Y)$ be defined by:

$$F(Y)_n = \mathbf{C}_n \times Y_n, \quad f_*(g, y) = (f_*(g), (g^*(f))_*(y))$$

and $h^*(g, y) = (hg, y)$ for f in Δ^{op} , g and $h \in \mathbf{C}_n$, $y \in Y_n$.

- 7.1.6 Lemma.** (i) $F(Y)$ is a cyclic space (in particular $F(\text{pt}) = \mathbf{C}$ is a cyclic set, as already shown),
 (ii) if X is a cyclic space, then the evaluation map $\text{ev}: F(X) \rightarrow X$, given by $(g, x) \mapsto g_*(x)$ is a morphism of cyclic spaces,
 (iii) the functor $F: (\mathbf{Simplicial\ spaces}) \rightarrow (\mathbf{Cyclic\ spaces})$ is left adjoint to the forgetful functor.

Proof. (i) Another way of interpreting the action of $\Delta^{\text{C}^{\text{op}}}$ on $F(Y)$ defined in 7.1.5 is the following. For $a \in \text{Hom}_{\Delta^{\text{C}^{\text{op}}}}([m], [n])$ and $g \in \mathbf{C}_m \subset$

$\text{Hom}_{\Delta C^{\text{op}}}([m], [m])$ let us write $a \circ g = a_*(g) \circ g^*(a)$ with $a_*(g) \in \mathbf{C}_n$ and $g^*(a) \in \text{Hom}_{\Delta^{\text{op}}}([m], [n])$. Then, the action of a on $F(Y)_n$ is given by $a_*(g, y) = (a_*(g), (g^*(a))_*(y))$. From the uniqueness of the decomposition (Theorem 6.1.3) it is clear that this defines a functor from ΔC^{op} to (**Spaces**).

(ii) With the same notation as before we have:

$$\begin{aligned} \text{ev}(a_*(g, x)) &= \text{ev}(a_*(g), g^*(a)_*(x)) \\ &= a_*(g)_*(g^*(a)_*(x)) = (a_*(g) \circ g^*(a))_*(x) \\ &= (a \circ g)_*(x) = a_*(g_*(x)) = a_*(\text{ev}(g, x)). \end{aligned}$$

(iii) Let $\iota : X \rightarrow F(X)$ be the inclusion of simplicial spaces given by $x \mapsto (1, x)$, where 1 denotes the neutral element of \mathbf{C}_n . Let Y be a cyclic space and let $\alpha : F(X) \rightarrow Y$ be a morphism of cyclic spaces. Then $\alpha \circ \iota : X \rightarrow Y$ is a morphism of simplicial spaces.

In the other way, if $\beta : X \rightarrow Y$ is a map of simplicial spaces, then $\text{ev} \circ F(\beta) : F(X) \rightarrow Y$ is a map of cyclic spaces.

It is straightforward to verify that these two constructions are inverse to each other and define bijections between $\text{Hom}_{\mathbf{Simp}}(X, Y)$ and $\text{Hom}_{\mathbf{Cycl}}(F(X), Y)$. \square

7.1.7 Comparison of $F(X)$ and $\mathbf{C} \times X$. Though the simplicial space $F(X)$ is not the product $\mathbf{C} \times X$ in general, this becomes true after geometric realization. This is the matter of the next lemma.

Let $p_1 : |F(X)| \rightarrow |\mathbf{C}|$ be the map induced by the projection of cyclic spaces $(g, x) \mapsto g$.

The map $p_2 : |F(X)| \rightarrow |X|$ is defined as follows. Let $(g, x; u) \in F(X)_n \times \Delta^n$, and put $p_2(g, x; u) = (x; g^*(u))$. In this formula we use the cocyclic structure of Δ (cf. 7.1.3). This map is well-defined, (i.e. passes to the equivalence relation which defines the geometric realization) because for any $f \in \text{Hom}_{\Delta^{\text{op}}}([m], [n])$ one has

$$\begin{aligned} p_2(f_*(g, x); u) &= p_2((f_*(g), g^*(f)_*(x)); u) \\ &= (g^*(f)_*(x); f_*(g)^*(u)) \\ &= (x; g^*(f)_*(f_*(g)^*(u))) = (x; (g \circ f)^*(u)) \\ &= (x; g^*(f^*(u))) \\ &= p_2((g, x); f^*(u)). \end{aligned}$$

7.1.8 Lemma. *For any simplicial space X the map $(p_1, p_2) : |F(X)| \rightarrow |\mathbf{C}| \times |X| = S^1 \times |X|$ is a homeomorphism.*

Proof. Let $\mathbf{C} \times X$ be the simplicial space product and let $h_X : |F(X)| \rightarrow |\mathbf{C} \times X|$ be defined by $h_X(g, x; u) = (g^{-1}, x; g^*(u))$. This map is well-defined

(same calculation as above) and is a homeomorphism. With this notation (p_1, p_2) is the composite map

$$|F(X)| \xrightarrow{h_X} |\mathbf{C} \times X| \xrightarrow{|\text{proj}_1| \times |\text{proj}_2|} |\mathbf{C}| \times |X| \xrightarrow{h_{pt} \times id} |\mathbf{C}| \times |X|$$

(remark that $F(pt) = \mathbf{C}$), where proj_1 and proj_2 are the two simplicial projections. □

7.1.9 Definition of the Action. Let X be a cyclic space. Then the map $\zeta : |\mathbf{C}| \times |X| \rightarrow |X|$ is by definition $\zeta := |\text{ev}| \circ (p_1, p_2)^{-1}$, where p_1 and p_2 were described in 7.1.7 and where ev is the evaluation map described in 7.1.6.ii.

7.1.10 Lemma. $|\mathbf{C}| = S^1$ and $\zeta : |\mathbf{C}| \times |\mathbf{C}| \rightarrow |\mathbf{C}|$ is the usual group structure on S^1 .

Proof. The identification $|\mathbf{C}| = S^1$ was done in 7.1.2. In the following commutative diagram

$$\begin{array}{ccccc} |\mathbf{C}| \times |\mathbf{C}| & \xleftarrow{(p_1, p_2)} & |F(\mathbf{C})| & \xrightarrow{\text{ev}} & |\mathbf{C}| \\ \parallel & & \downarrow \cong & & \parallel \\ S^1 \times S^1 & \xleftarrow{id} & S^1 \times S^1 & \longrightarrow & S^1 \end{array}$$

the identification of $|F(\mathbf{C})|$ with $S^1 \times S^1$ is given as follows. The simplicial set $F(\mathbf{C})$ has 3 non-degenerate 1-simplices $(1, t_1)$, $(t_1, 1)$, and (t_1, t_1) ; and 2 non-degenerate 2-simplices (t_2, t_2) and (t_2^2, t_2^2) . They assemble as follows to give $S^1 \times S^1$.

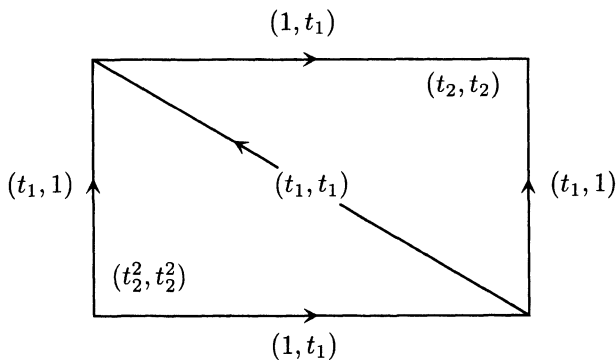

Let us just check one case (by using 6.1.2):

$$d_0(t_2, t_2) = (d_0(t_2), t_2^*(d_0)_*(t_2)) = (1, d_2(t_2)) = (1, t_1) .$$

For $(u, v) \in [0, 1]^2$ we have $(u, v) \in \{(t_2^2, t_2^2)\} \times \Delta^2$ if $u + v \leq 1$ and $(u, v) \in \{(t_2, t_2)\} \times \Delta^2$ if $u + v \geq 1$. By the evaluation map we get $\text{ev}(t_2, t_2) = t_2^2 = s_0(t_1)$ and $\text{ev}(t_2^2, t_2^2) = t_2^4 = t_2 = s_1(t_1)$. In the first case $|\text{ev}|$ sends (u, v) to $u + v \in \{t_1\} \times \Delta^1$ and in the second case $|\text{ev}|$ sends (u, v) to $u + v - 1 \in \{t_1\} \times \Delta^1$. This is exactly the usual multiplication in $S^1 = \Delta^1 / \{0 = 1\} = \mathbb{R}/\mathbb{Z}$. \square

Remark. The trick is that there are two ways to triangulate $S^1 \times S^1$, one is $\mathbf{C} \times \mathbf{C}$ and the other one is $F(\mathbf{C})$. It is the latter one which behaves well with respect to the group structure.

7.1.11 Proof of Theorem 7.1.4. The map $\mu : FF(X) \rightarrow F(X)$, $(g, h, x) \mapsto (gh, x)$ is a map of cyclic spaces. Define

$$\begin{aligned} p'_1 : |FF(X)| &\rightarrow |F(\mathbf{C})|, & (g, h, x; u) &\rightarrow (g, h; u), & \text{and} \\ p'_2 : |FF(X)| &\rightarrow |X|, & (g, h, x; u) &\mapsto (x; (gh)_*u). \end{aligned}$$

Same arguments as for p_2 show that they are well-defined and (p'_1, p'_2) is a homeomorphism.

In the following diagram, X is a cyclic space. The four outer triangles are commutative by definition of ζ (cf. 7.1.9). The four inner squares are commutative by direct inspection.

Since the maps in the “wrong” directions are all homeomorphisms (Lemma 7.1.8), it follows that the outer circle is commutative and this proves that the action of S^1 on $|X|$ is well-defined. The functoriality is immediate by construction. See figure on next page. \square

Exercises

E.7.1.1. Let $\{\mathbb{Z}\}$ be the crossed simplicial group of 6.3.4.c (same presentation as for \mathbf{C} but without the relation $t_n^{n+1} = 1$). Show that $|\{\mathbb{Z}\}| = \mathbb{R}$ as a topological group and that the natural quotient map $\{\mathbb{Z}\} \rightarrow \mathbf{C}$ induces the universal covering $\mathbb{R} \rightarrow S^1$ on the geometric realization. Show that the geometric realization of the fundamental crossed simplicial groups are as described in 6.3.6.

E.7.1.2. Let \mathbf{C}^k be the crossed simplicial group described in 6.3.4.d (same presentation as for \mathbf{C} but with relation $t_n^{n+1} = 1$ replaced by $t_n^{k(n+1)} = 1$). Show that $|\mathbf{C}^k| = S^1$ as a topological group and that the natural quotient map $\mathbf{C}^k \rightarrow \mathbf{C}$ is a k -fold cover on the geometric realization.

E.7.1.3. Show that, in the framework of simplicial modules, the left adjoint to the forgetful functor from **(Cyclic modules)** to **(Simplicial modules)** is given by $F(M)_n = k[\mathbf{C}_n] \otimes M_n$ with formulas like in 7.1.5 extended by linearity. Show that for any simplicial module M there are canonical isomorphisms $HC_*(F(M)) \cong H_*(M)$, and $H_*(F(M)) \cong H_*(M) \oplus H_{*-1}(M)$ (compare with 2.5.17).

E.7.1.4. Show that this section can be extended mutatis mutandis to any crossed simplicial group G , in place of \mathbf{C} . In particular $|G|$ is a topological group and for any ΔG^{op} -space X , the space $|X|$ is equipped with a $|G|$ -action (cf. Fiedorowicz-Loday [1991]).

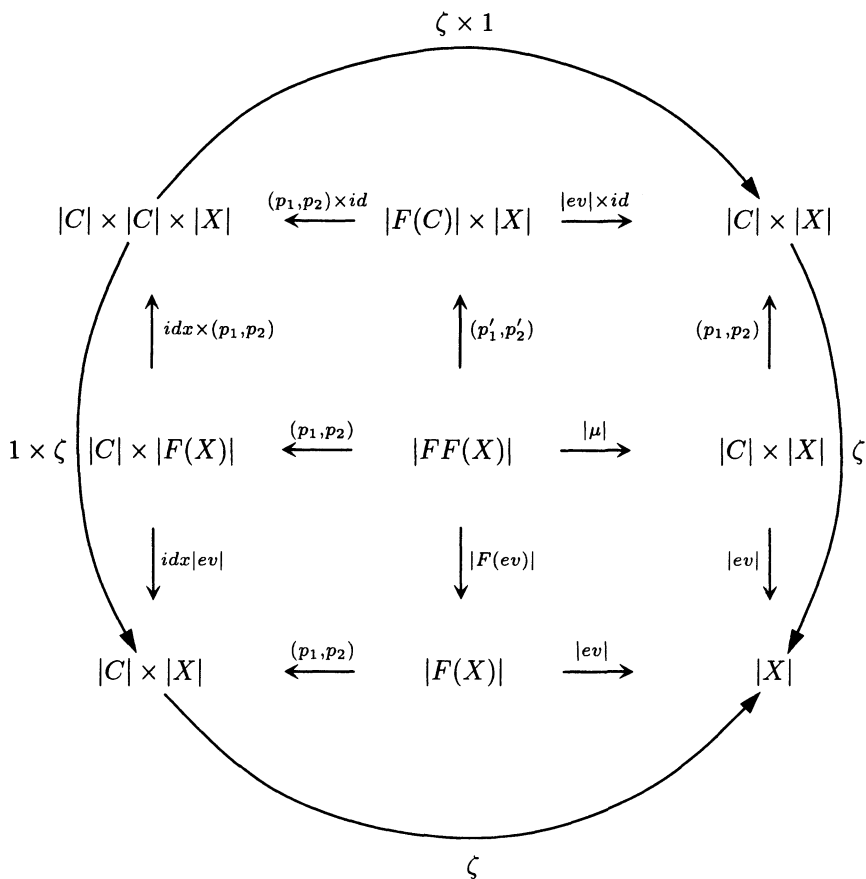

7.2 Cyclic Homology and S^1 -Equivariant Homology

For any simplicial set X the homology of its associated simplicial module $k[X]$ is the homology of the geometric realization $|X|$ with coefficients in k . Our aim in this section is to interpret similarly the cyclic homology groups $HC_*(k[X])$ of $k[X]$ for a cyclic set X . The answer can be given in terms of S^1 -equivariant homology of the S^1 -space $|X|$. One may as well introduce the space $|X|^{\text{cy}} = ES^1 \times_{S^1} |X|$ and then the result takes the form $HC_*(k[X]) \cong H_*(|X|^{\text{cy}}, k)$. Under these isomorphisms the Connes periodicity exact sequence becomes the Gysin exact sequence of an S^1 -fibration.

Our proof has the advantage of being easily translated to other functors and categories. This is done for some cases in the final part of the section.

7.2.1 Borel Construction and S^1 -Equivariant Homology. Let Z be an S^1 -space and let ES^1 be a contractible space with free S^1 -action (cf. Appendix B.12). Then the Borel space $ES^1 \times_{S^1} Z$ is the quotient of the product $ES^1 \times Z$ by the equivalence relation

$$(y, g \cdot z) \sim (g^{-1} \cdot y, z) \text{ for any } y \in ES^1, \text{ any } z \in Z \text{ and any } g \in S^1.$$

Remark that this is a sort of tensor product in the topological framework. If $Z = \{*\}$, then its Borel space is simply $ES^1 \times_{S^1} \{*\} = ES^1/S^1 = BS^1$, that is the classifying space of the topological group S^1 . This space is an Eilenberg-Mac Lane space of type $K(\mathbb{Z}, 2)$. Up to homotopy it is also the infinite complex projective space $\mathbb{C}P^\infty$.

By definition the S^1 -equivariant homology of the S^1 -space Z is

$$H_*^{S^1}(Z, k) := H_*(ES^1 \times_{S^1} Z, k).$$

7.2.2 Cyclic Geometric Realization. Let X be a cyclic space (for instance a cyclic set). By Theorem 7.1.4 the space $|X|$ is an S^1 -space and, by definition, the *cyclic geometric realization* of X is the Borel space

$$|X|^{\text{cy}} := ES^1 \times_{S^1} |X|.$$

Note that if X is the trivial cyclic set $\{*\}$, then $|\{*\}|^{\text{cy}} = ES^1 \times_{S^1} \{*\} = BS^1$.

7.2.3 Theorem. *Let X be a cyclic set and let $k[X]$ be its associated cyclic module.*

(a) *There is a canonical isomorphism*

$$HC_*(k[X]) \cong H_*(|X|^{\text{cy}}, k) =: H_*^{S^1}(|X|, k),$$

(b) *under this identification and the identification $H_*(k[X]) \cong H_*(|X|, k)$ the Gysin sequence of the homotopy fibration $S^1 \rightarrow |X| \rightarrow |X|^{\text{cy}}$ coincides with Connes' exact sequence:*

$$\begin{array}{cccccccc} \dots & \rightarrow & H_n(k[X]) & \rightarrow & HC_n(k[X]) & \rightarrow & HC_{n-2}(k[X]) & \rightarrow & H_{n-1}(k[X]) & \rightarrow & \dots \\ & & \downarrow \cong & & \downarrow \cong & & \downarrow \cong & & \downarrow \cong & & \\ \dots & \rightarrow & H_n(|X|, k) & \rightarrow & H_n(|X|^{\text{cy}}, k) & \rightarrow & H_{n-2}(|X|^{\text{cy}}, k) & \rightarrow & H_{n-1}(|X|, k) & \rightarrow & \dots \end{array}$$

For the Gysin sequence of a fibration with fiber S^1 , see Appendix D.6.

7.2.4 Homotopy Colimits and Plan of the Proof of 7.2.3.a. Recall from Appendix B.13 that for any small category \mathcal{C} and any functor $X : \mathcal{C} \rightarrow (\mathbf{Spaces})$ such that $X(C)$ is an ANR for every object C , there is defined the Bousfield-Kan category \mathcal{C}_X as follows. An object of \mathcal{C}_X is a pair (C, x) where $C \in \text{Obj}(\mathcal{C})$ and $x \in X(C)$. A morphism $(C, x) \rightarrow (C', x')$ is a morphism $f : C \rightarrow C'$ such that $f(x) = x'$. The classifying space BC_X of this topological category is the geometric realization of its nerve $B\mathcal{C}_X$ (nerve which is a simplicial space). This space is often called the *homotopy colimit* of the functor X .

In the particular case $\mathcal{C} = \Delta^{\text{op}}$ (resp. $\mathcal{C} = \Delta C^{\text{op}}$) we denote by $\|X\|$ (resp. $\|X\|^{\text{cy}}$) the classifying space of the category Δ_X^{op} (resp. ΔC_X^{op}) in order to simplify the notation. It is well-known (cf. Appendix B) that there is a homotopy equivalence (in fact a deformation retraction) $\|X\| \xrightarrow{\sim} |X|$. One of our main points is to prove a similar result in the cyclic framework (cf. Proposition 7.2.6).

The proof of Theorem 7.2.3 consists in providing a sequence of isomorphisms

$$(7.2.4.1) \quad HC_*(k[X]) \stackrel{1}{\cong} \text{Tor}_*^{\Delta C^{\text{op}}}(k, k[X]) \stackrel{2}{\cong} \text{Tor}_*^{\Delta C_X^{\text{op}}}(k, k) \\ \stackrel{3}{\cong} H_*(\|X\|^{\text{cy}}, k) \stackrel{4}{\cong} H_*(|X|^{\text{cy}}, k) .$$

Isomorphism 1 was proved in 6.2.8. Isomorphism 2 is a particular case of a result valid for any small categories (cf. Appendix C.12). Isomorphism 3 is a particular case of the more general isomorphism $\text{Tor}_*^{\mathcal{C}}(k, k) \cong H_*(BC, k)$ (cf. Appendix C.10). So the main point is in proving that there is a homotopy equivalence $\|X\|^{\text{cy}} = B\Delta C_X^{\text{op}} \xrightarrow{\sim} |X|^{\text{cy}}$. This is done in 7.2.6.

Note that there is an analogous sequence of isomorphisms for a simplicial set:

$$(7.2.4.2) \quad H_*(k[X]) \stackrel{1}{\cong} \text{Tor}_*^{\Delta^{\text{op}}}(k, k[X]) \stackrel{2}{\cong} \text{Tor}_*^{\Delta_X^{\text{op}}}(k, k) \\ \stackrel{3}{\cong} H_*(\|X\|, k) \stackrel{4}{\cong} H_*(|X|, k) ,$$

which gives an alternative proof for the identification $H_*(k[X]) \cong H_*(|X|, k)$.

7.2.5 Lemma. *For any simplicial space X the inclusion functor $\Phi : \Delta_X^{\text{op}} \rightarrow \Delta C_{F(X)}^{\text{op}}$ induces a homotopy equivalence on the classifying spaces, $\|X\| \xrightarrow{\sim} \|F(X)\|^{\text{cy}}$.*

Proof. The functor Φ is completely determined by its value on objects, it simply sends $([n], x)$ to $([n], (1, x))$ where $(1, x) \in F(X)_n = \mathbf{C}_n \times X_n$ (here 1 is the neutral element of \mathbf{C}_n). In order to prove the homotopy equivalence we construct a functor $\Psi : \Delta C_{F(X)}^{\text{op}} \rightarrow \Delta_X^{\text{op}}$ the other way round and show that

- (a) $\Psi \circ \Phi = Id$,
- (b) there is a natural transformation of functors γ from $\Phi \circ \Psi$ to Id . These two facts imply that $B\Phi$ is a homotopy equivalence since $B\Psi \circ B\Phi = id$ by (a) and $B\Phi \circ B\Psi$ is homotopic to id by (b).

The functor Ψ is constructed as follows. On objects $\Psi([n], (g, x)) = ([n], x)$. On morphisms the image of

$$\phi^* : ([n], (g, x)) \mapsto ([m], (\phi^*(g), (g^*(\phi))^*(x)))$$

is $g^*(\phi) : ([n], x) \mapsto ([m], (g^*(\phi))^*(x))$ for $\phi \in \text{Hom}_\Delta$ and the image of $h^* : ([n], (g, x)) \mapsto ([n], (h \circ g, x))$ is $id : ([n], x) \mapsto ([n], x)$ for $h \in C_n$.

It is immediate from the definition that $\Psi \circ \Phi = Id$.

The natural transformation γ from $\Phi \circ \Psi$ to $Id_{\Delta C^{\text{op}}}$ is given by

$$\gamma([n], (g, x)) := g : \{\Phi \circ \Psi([n], (g, x)) = ([n], (1, x))\} \rightarrow ([n], (g, x)) .$$

The fact that γ is a natural transformation of functors is a consequence of the formulas of Proposition 6.1.6. □

7.2.6 Proposition. *For any cyclic space X there is a canonical homotopy equivalence (in fact a deformation retraction):*

$$\|X\|^{\text{cy}} \xrightarrow{\sim} |X|^{\text{cy}} = ES^1 \times_{S^1} |X| .$$

In particular we get

$$B\Delta C^{\text{op}} = \|\{*\}\|^{\text{cy}} \xrightarrow{\sim} |\{*\}|^{\text{cy}} = BS^1 .$$

Proof. Let $F^\bullet X$ be the simplicial functor which is $F^{n+1}X = F(F(\dots(FX)\dots))$ in dimension n . The faces and degeneracies are defined like in the bar resolution $C^{\text{bar}}(A, M)$ (cf. 1.1.11) by using the map $\mu : FFY \rightarrow FY$ in place of the multiplication in A and the evaluation map $\text{ev} : FX \rightarrow X$ in place of the module structure of M . By iterating the evaluation map we get $F^{n+1}X \rightarrow X$ which defines a map of simplicial functors $F^\bullet X \rightarrow X$, where X is considered as a trivial simplicial functor. There is an obvious inclusion functor $X \rightarrow F^\bullet X$ and the composite $X \rightarrow F^\bullet X \rightarrow X$ is the identity. Let us denote by EV the composite the other way round $F^\bullet X \rightarrow X \rightarrow F^\bullet X$. There exists a simplicial homotopy h from $Id_{F^\bullet X}$ to EV . It is given by $h_i : F^{n+1}X \rightarrow F^{n+2}X$, $h_i(g_0, \dots, g_n, x) = (1, \dots, 1, g_0g_1 \dots g_i, g_{i+1}, \dots, g_n, x)$ for $i = 0, \dots, n$ (compare with the proof of the acyclicity of the bar-resolution in 1.1.12). Applying the functor $\| - \|$ dimensionwise, and then taking the geometric realization $| - |$ we get a homotopy equivalence

$$\|[n]\} \mapsto \|F^n X\| \sim \|X\| .$$

On the other hand, by Lemma 7.2.5 we have

$$\|F^{n+1}X\|^{\text{cy}} \sim \|F^n X\| \sim |F^n X| \sim |(C)^n \times X|$$

since X is cyclic (cf. 7.1.8). Therefore $\|F^{n+1}X\|^{\text{cy}} \sim (S^1)^n \times |X|$. The simplicial structure of $[n] \mapsto (S^1)^n \times |X|$ is such that $|(S^1)^n \times |X|| \cong ES^1 \times_{S^1} |X|$ (cf. Appendix B.12), therefore $\|[n] \mapsto \|F^n X\|\| \sim ES^1 \times_{S^1} |X|$ and this completes the proof. \square

7.2.7 Proposition. *For any cyclic space X the vertical arrows of the following commutative diagram are homotopy equivalences and the horizontal rows are homotopy fibrations,*

$$\begin{array}{ccccc} B\Delta_X^{\text{op}} & \rightarrow & B\Delta_C^{\text{op}} & \rightarrow & B\Delta C^{\text{op}} \\ \downarrow \sim & & \downarrow \sim & & \downarrow \sim \\ |X| & \rightarrow & ES^1 \times_{S^1} |X| & \rightarrow & BS^1. \\ & & \parallel & & \\ & & |X|^{\text{cy}} & & \end{array}$$

Proof. By Proposition 7.2.6 the middle vertical map is a homotopy equivalence. Similarly the right-hand side vertical map is a homotopy equivalence since it is the particular case $X = \{*\}$, $B\Delta_C^{\text{op}} = B\Delta C^{\text{op}}$ and $ES^1 \times_{S^1} \{*\} = BS^1$. By Lemma 7.2.5, Proposition 7.2.6 for $F(X)$ and Lemma 7.1.8 there is a sequence of homotopy equivalences

$$\begin{aligned} \|X\| \rightarrow \|F(X)\|^{\text{cy}} \rightarrow ES^1 \times_{S^1} |F(X)| \rightarrow ES^1 \times_{S^1} (S^1 \times |X|) \\ = ES^1 \times |X| \rightarrow |X|, \end{aligned}$$

whose composite is the left-hand side vertical homotopy equivalence.

The horizontal maps are induced by the evaluation map $ev : F(X) \rightarrow X$ and the trivial map $X \rightarrow \{*\}$ respectively, so the diagram is commutative. Since all the vertical maps are homotopy equivalences and since the lower line is a fibration by construction, the upper line is a homotopy fibration. \square

7.2.8 Remark. An alternative proof of Propositions 7.2.6 and 7.2.7 is to show, first, that the first line of the diagram is a fibration (by using Quillen’s theorem B for instance). Then, since the extreme vertical maps of the diagram are homotopy equivalences, so is the middle one.

Proof of part b) of Theorem 7.2.3. The Gysin exact sequence is the homology exact sequence deduced from the spectral sequence associated to the fibration

$$S^1 \rightarrow ES^1 \times |X| \rightarrow ES^1 \times_{S^1} |X|,$$

(cf. Appendix D.6). However it can also be deduced from the homology spectral sequence associated to the fibration 7.2.7 with base-space BS^1 . This spectral sequence comes from a filtration of the complex of chains on the total space $ES^1 \times_{S^1} |X|$. A straightforward (but tedious) verification shows

that, via all the isomorphisms of 7.2.4.1, this filtration corresponds to the filtration by columns on $C(k[X])$. Indeed the terms E_{pq}^1 are 0 if p is odd and are $H_q(|X|) \cong H_q(k[X])$ if p is even. On the abutment we get the identification $H_n(|X|^{cy}) \cong HC_n(k[X])$.

This finishes the proof of Theorem 7.2.3. □

7.2.9 Generalizations of the Main Theorem (7.2.3). Let us recall briefly the proof of Theorem 7.2.3 in a slightly more abstract framework. For any small category \mathcal{C} and functor $X : \mathcal{C} \rightarrow (\mathbf{Sets})$ the associated \mathcal{C} -module $k[X] : \mathcal{C} \rightarrow (k\text{-Modules})$ gives rise to homology groups $\text{Tor}_*^{\mathcal{C}}(k, k[X])$. Steps 2 and 3 of 7.2.4 show that there is a canonical isomorphism

$$\text{Tor}_*^{\mathcal{C}}(k, k[X]) \cong H_*(BC_X, k).$$

In the case $\mathcal{C} = \Delta^{C^{op}}$ (or Δ^{op}) a particular resolution of the trivial \mathcal{C} -module k gives rise to a particular complex interpretation of the Tor-group (isomorphism 1). On the other hand one is able to give another type of geometric realization for the functor X (isomorphism 4). Combining all these isomorphisms gives the final theorem.

This can be applied equally well to several other categories and functors. The following theorems are concerned with the categories $(\Delta \times \Delta C)^{op}$ and ΔG^{op} .

Any (good) cyclic space $X : \Delta C^{op} \rightarrow (\mathbf{Spaces})$ gives rise to a functor $S.X : (\Delta \times \Delta C)^{op} \rightarrow (\mathbf{Sets})$ by taking the singular functor in each dimension. This gives rise to a cyclic chain complex S_*X . (cf. 2.5.3), whose cyclic homology is the $\text{Tor}^{\mathcal{C}}$ -group.

On the other hand it is not too difficult to prove, by using the same technique as in 7.2.6, that $B\Delta C_X^{op}$ is homotopy equivalent to $ES^1 \times_{S^1} |X|$. Therefore we get the following generalization of 7.2.3:

7.2.10 Theorem. *Any cyclic space X , gives rise to a cyclic chain complex S_*X , and there are canonical isomorphisms*

$$H_*(k[S_*X]) \cong H_*(|X|, k) \quad \text{and} \quad HC_*(k[S_*X]) \cong H_*(ES^1 \times_{S^1} |X|, k),$$

which convert Connes' periodicity exact sequence into the Gysin exact sequence. □

Another example is given by the crossed simplicial groups (cf. Sect. 6.3). Let G be a crossed simplicial group, ΔG its associated category, and let $X : \Delta G^{op} \rightarrow (\mathbf{Sets})$ be a functor. Then $G = |G|$ is a topological group and the geometric realization $|X|$ of the underlying simplicial set is equipped with a (continuous) G -action.

7.2.11 Theorem. *For any crossed simplicial group G , and any functor $X : \Delta G^{op} \rightarrow (\mathbf{Sets})$ there is a canonical isomorphism*

$$\mathrm{Tor}_*^{\Delta G^{\mathrm{op}}}(k, k[X]) \cong H_*(EG \times_G |X|, k).$$

In particular, if $G = \mathbf{D}$. (resp \mathbf{Q} .), then for any dihedral or quaternionic set X , there are, respectively, isomorphisms

$$\begin{aligned} HD_*(k[X]) &\cong H_n(EO(2) \times_{O(2)} |X|, k), \\ HQ_*(k[X]) &\cong H_n(EPin(2) \times_{Pin(2)} |X|, k). \end{aligned} \quad \square$$

Here $O(2)$ is the orthogonal group of 2×2 -matrices and $Pin(2)$ is the normalizer of $S^1 = SO(2)$ in $SU(2) = S^3$.

Exercises

E.7.2.1. For a fixed integer n let $\Delta C[n]$ be the cyclic set

$$[m] \mapsto \mathrm{Hom}_{\Delta C}([m], [n]).$$

Show that the geometric realization ΔC^n of $\Delta C[n]$ is homeomorphic to $S^1 \times \Delta^n$.

Show that ΔC is naturally equipped with a structure of cocyclic space. Show that, under the above homeomorphism, the action of the cyclic operator on $S^1 \times \Delta^n$ is given by

$$\tau_n(z; u_0, \dots, u_n) = (z \exp(-2\pi i u_0); u_1, \dots, u_n, u_0)$$

where $\Delta^n = \{(u_0, \dots, u_n) \mid 0 \leq u_i \leq 1, \sum u_i = 1\} \subset \mathbb{R}^{n+1}$.

Show that there is a canonical homeomorphism

$$|X|^{cyc} = X \times_{\Delta C} \Delta C = X \times_{\Delta C} (S^1 \times \Delta).$$

(Cf. Goodwillie [1985a] and Jones [1987].)

E.7.2.2. Cyclic singular functor. Let Z be an S^1 -space and let the action of S^1 on $S^1 \times \Delta^n$ be by multiplication on the first factor. Let $S_n(Z) = \mathrm{Map}^{S^1}(S^1 \times \Delta^n, Z)$. Show that S is a functor from the category of S^1 -spaces to the category of cyclic sets. Prove that S is right adjoint to $|-|^{cyc}$. Let $\mathcal{S}(Z) = k[S_n(Z)]$ be the associated module. Show that

$$HH_n(\mathcal{S}(Z)) = H_n(Z, k) \quad \text{and} \quad HC_n(\mathcal{S}(Z)) = H_n^{S^1}(Z, k).$$

(Use the cocyclic space structure of $[n] \mapsto S^1 \times \Delta^n$ described above, cf. Jones [1987].)

E.7.2.3. Prove that the homotopy theory of cyclic spaces is equivalent to the homotopy theory of S^1 -spaces (in the sense of Quillen) (cf. Dwyer-Hopkins-Kan [1985]).

E.7.2.4. Let X (resp. Y) be a connected pointed CW -complex (resp. finite CW -complex). Show that there is a canonical isomorphism

$$\overline{HC}^*(\mathcal{S}(X), \mathcal{S}(Y)) \xrightarrow{\sim} H_{S^1}^*(X, Y),$$

where $\overline{HC}_*(-, -)$ is reduced bivariant cyclic cohomology and $H_{S^1}^*(-, -)$ is equivariant bivariant cohomology (cf. Solotar [1992]).

E.7.2.5. Let X be a cocyclic set, that is a functor $X : \Delta C \rightarrow (\mathbf{Sets})$. Show that the geometric realization of the underlying cosimplicial set is equipped with an S^1 -action (cf. Jones [1987]).

7.3 Examples of Cyclic Sets and the Free Loop Space

After comparing two standard simplicializations of the circle we study two examples of cyclic spaces: the twisted nerve of a group and the cyclic bar construction on groups. Both of these constructions will be helpful in studying cyclic homology of group algebras. Moreover the cyclic bar construction gives rise to the free loop space.

Notation. For any space X , the free loop space $\mathcal{L}X$ is the space of all continuous maps $S^1 \rightarrow X$, with the compact-open topology. When X is basepointed the (ordinary) loop space ΩX , made of basepointed loops, is a subspace of $\mathcal{L}X$.

7.3.1 Cyclic Homology of k and Homology of BS^1 . The simplest cyclic set $\{*\}$ is made of one point in each dimension. By 7.2.2 its cyclic geometric realization is $|\{*\}|^{cy} = ES^1 \times_{S^1} \{*\} = BS^1$. On the other hand the cyclic module associated to $\{*\}$ is simply the trivial cyclic module k . Therefore Theorem 7.2.3 gives an identification

$$k[u] \cong HC_*(k) = HC_*(k[\{*\}]) \xrightarrow{\sim} H_*(BS^1, k).$$

Under this isomorphism the generator $u \in HC_2(k)$ (class of $(1, 1, 1)$) corresponds to the classical generator of $H_2(BS^1, k)$ obtained by transgression from the generator $1 \in k \cong H_1(S^1, k)$.

7.3.2 Simplicializations of the Circle. There are several ways of obtaining the circle, up to homotopy, as the geometric realization of a simplicial set. As already mentioned the simplest one is \mathbf{C} . (cf. 7.1.2), which is a cyclic set. It was shown in 7.1.10 that the S^1 -structure of $|\mathbf{C}| = \mathbb{R}/\mathbb{Z} = S^1$ is precisely the group structure of S^1 inherited from the addition in \mathbb{R} .

Another classical simplicial set is the nerve of the discrete group \mathbb{Z} . In fact the homotopy equivalence $S^1 \rightarrow B\mathbb{Z} = |B.\mathbb{Z}|$ is induced by the simplicial map $\mathbf{C} \rightarrow B.\mathbb{Z} = \mathbb{Z}^n$ given by

$$t_n^0 \mapsto (0, \dots, 0)$$

and $t_n^i \mapsto (0, \dots, 1, \dots, 0) \in \mathbb{Z}^n = B_n\mathbb{Z}$, for $i = 1, \dots, n$.

In terms of the cyclic theory the interesting point is the following: there is a cyclic structure on $B\mathbb{Z}$ such that the above map is a map of cyclic sets. Indeed the cyclic structure is given by

$$t_n(m_1, \dots, m_n) = (1 - (m_1 + \dots + m_n), m_1, \dots, m_{n-1}) .$$

The homotopy equivalence $S^1 \rightarrow B\mathbb{Z}$ is S^1 -equivariant for the S^1 -action of $B\mathbb{Z}$ induced by the cyclic action.

7.3.3 The Twisted Nerve of a Group. Let G be a topological group and consider its nerve $B.G$ which is a simplicial space such that $B_nG = G^n$ (cf. Appendix B.12). Let z be an element in the center of G and define an action of the cyclic operator t_n on B_nG by

$$(7.3.3.1) \quad t_n(g_1, \dots, g_n) = (z(g_1g_2 \dots g_n)^{-1}, g_1, \dots, g_{n-1}) .$$

One checks easily that this puts a cyclic structure on the nerve of G (cyclic structure which depends on the choice of z). In particular

$$t_n^{n+1}(g_1, \dots, g_n) = (zg_1z^{-1}, \dots, zg_nz^{-1})$$

and so $t_n^{n+1} = id$ because z is central. Note that the verification of the other relations (see 6.1.2.b) do not require z to be central. This cyclic space is denoted by $B.(G, z)$ and called the *twisted nerve* of (G, z) . In particular for $z = 1$ we get a canonical cyclic structure on the nerve $B.(G)$.

For $G = \mathbb{Z}$ and $z = 1$ (additive notation), this is the cyclic set used in 7.3.2.

7.3.4 Proposition. *Let G be a discrete group and z an element in its center. Let $\gamma_z : \mathbb{Z} \times G \rightarrow G$ be the group homomorphism given by $\gamma_z(n, g) = z^n g$. Then, up to homotopy, the action of S^1 on $BG = |B.(G, z)|$ induced by the cyclic structure is the composite*

$$S^1 \times BG \xrightarrow{\sim} B(\mathbb{Z} \times G) \xrightarrow{B\gamma_z} BG .$$

Proof. It suffices to compute the image by π_1 of the action of $(1, g) \in \mathbb{Z} \times G = \pi_1(S^1 \times BG)$. Consider the commutative diagram

$$\begin{array}{ccc} (t_1, g; u) \in |FB.G| & \xrightarrow{|\text{lev}|} & |B.G| \ni ((t_1)_*(g); u) \\ \downarrow (p_1, p_2) & & \parallel \\ (t_1; u) \times (g; t_1^*(u)) \in |\mathbf{C}.| \times |B.G| & \xrightarrow{\text{action}} & |B.G| \ni (zg^{-1}; u) \end{array}$$

where the elements describe loops when u varies over $\Delta^1 = [0, 1]$.

By definition of $t_1^* = \tau_1$ (see 7.1.3) the homotopy class of the loop $(g; t_1^*(u))$ is g^{-1} . Therefore the image of $(1, g^{-1})$ is zg^{-1} and we are done. \square

Remark. In fact one can prove a more precise statement. For any group G there is a cellular map $\kappa_G : BG \rightarrow BG$ homotopic to the identity which is $(g; u) \mapsto (g^{-1}; t_1^*(u))$ on the 1-skeleton. Then the following diagram is strictly commutative

$$\begin{array}{ccc}
 S^1 \times BG & \xrightarrow{\text{action}} & BG \\
 = \downarrow & & \downarrow \kappa_G \\
 B\mathbb{Z} \times BG & & BG \\
 \kappa_{\mathbb{Z}} \times id \downarrow & \xrightarrow{B\gamma_z} & \\
 B\mathbb{Z} \times BG & & BG
 \end{array}$$

7.3.5 The Space $X(G, z)$. Let us denote by $X(G, z)$ the Borel space $ES^1 \times_{S^1} BG$ where S^1 acts on BG by γ_z . By Definition 7.2.2 and Proposition 7.3.4 we get $|B.(G, z)|^{cy} = X(G, z)$.

In the fibration

$$(7.3.5.1) \quad S^1 \rightarrow BG \rightarrow X(G, z)$$

the fiber map is induced by $\mathbb{Z} \rightarrow G, 1 \mapsto z$ and the action of $G = \pi_1(BG)$ on $\mathbb{Z} = \pi_1(S^1)$ is trivial (this is a crossed module, cf. Appendix C.8).

If z is of infinite order, then the map $z : \mathbb{Z} \rightarrow G$ is injective and $X(G, z)$ is an Eilenberg-Mac Lane space of type $K(G/\{z\}, 1)$. If z is of finite order, then the space $X(G, z)$ has only two nontrivial homotopy groups, $\pi_1(X(G, z)) = G/\{z\}$ and $\pi_2(X(G, z)) = \mathbb{Z}$.

The following result is an immediate consequence of Theorem 7.2.3, Proposition 7.3.4 and the above notation.

7.3.6 Corollary. *For any discrete group G and any central element $z \in G$ there is a canonical isomorphism*

$$HC_*(k[B.(G, z)]) \cong H_*(X(G, z), k).$$

In particular, if z is of infinite order in G , then

$$HC_*(k[B.(G, z)]) \cong H_*(G/\{z\}, k). \quad \square$$

Since we know that the action of π_1 on π_2 is trivial, the homotopy type of $X(G, z)$ depends on the Postnikov invariant which lies in $H^3(G/\{z\}, \mathbb{Z})$. When this invariant is trivial then $X(G, z)$ is homotopy equivalent to $B(G/\{z\}) \times BS^1$. This is the case for $z = 1$ (neutral element of G) for instance, for which $X(G, 1) = BG \times BS^1$. Here are some other cases.

7.3.7 Proposition. *If the group G is abelian and if z is of finite order in G , then $X(G, z)$ is homotopy equivalent to $BS^1 \times B(G/\{z\})$.*

Proof. The space $X(G, z)$ is the classifying space of the crossed module $z : \mathbb{Z} \rightarrow G$ (cf. Appendix C.8). Since \mathbb{Z} and G are abelian and since the action of G on \mathbb{Z} is trivial, the nerve of this crossed module is an abelian simplicial group. The geometric realization of an abelian simplicial group is a product of Eilenberg-Mac Lane spaces. The only nontrivial homotopy groups of $X(G, z)$ are $\pi_1 = G/\{z\}$ and $\pi_2 = \mathbb{Z}$, whence the result since $BS^1 = K(\mathbb{Z}, 2)$. \square

7.3.8 Proposition. *If z is of finite order in G , then*

$$H_*(X(G, z), \mathbb{Q}) \cong H_*(BS^1, \mathbb{Q}) \otimes H_*(B(G/\{z\}), \mathbb{Q}),$$

(in fact $X(G, z)$ is rationally homotopy equivalent to $BS^1 \times B(G/\{z\})$).

Proof. It suffices to show that the Postnikov invariant is torsion. Consider the Bockstein map

$$H^2(G/\{z\}, \mathbb{Z}/n\mathbb{Z}) \rightarrow H^3(G/\{z\}, \mathbb{Z})$$

deduced from the exact sequence $0 \rightarrow \mathbb{Z} \xrightarrow{n} \mathbb{Z} \rightarrow \mathbb{Z}/n\mathbb{Z} \rightarrow 0$. From the fibration (7.3.5.1) we deduce that the Postnikov invariant of $X(G, z)$ is the image under this map of the class of the extension (cf. Appendix C.7)

$$(7.3.8.1) \quad 0 \rightarrow \mathbb{Z}/n\mathbb{Z} \xrightarrow{1 \mapsto z} G \rightarrow G/\{z\} \rightarrow 0.$$

Since the H^2 group is torsion, the Postnikov invariant is torsion. \square

We now deal with another example of cyclic sets.

7.3.9 Cyclic Homology of a Group (the Case $z = 1$). In the particular case $z = 1$ the cyclic set $B.(G, 1)$ is simply denoted by $B.G$. Since the complex associated to the simplicial module $C(k[B.G])$ is the Eilenberg-Mac Lane complex of G (cf. Appendix C), one gets

$$H_*(k[B.G]) = H_*(BG, k) = H_*(G, k).$$

Similarly, cyclic homology of a discrete group G is denoted $HC_*(G)$ (the ground ring k is understood) and defined by

$$(7.3.9.1) \quad HC_*(G) := HC_*(k[B.G]).$$

Similarly, one puts:

$$HC_*^{\text{per}}(G) := HC_*^{\text{per}}(k[B.G]) \quad \text{and} \quad HC_*^-(G) := HC_*^-(k[B.G]).$$

By Theorem 7.3.4 the action of S^1 on BG is trivial, hence the basic fibration becomes simply

$$S^1 \rightarrow ES^1 \times BG \rightarrow BS^1 \times BG .$$

From the triviality of this fibration it follows immediately that there is an isomorphism of graded $k[u]$ -comodules ($|u| = 2$):

$$(7.3.9.2) \quad HC_*(G) \cong k[u] \otimes H_*(G)$$

and that Connes periodicity exact sequence becomes

$$(7.3.9.3) \quad 0 \rightarrow H_n(G) \xrightarrow{I} HC_n(G) \xrightarrow{S} HC_{n-2}(G) \rightarrow 0 .$$

Moreover I is split injective and identifies $H_n(G)$ with the component $1 \otimes H_*(G)$ of $k[u] \otimes H_*(G)$. The map S is given by $S(u^n \otimes x) = u^{n-1} \otimes x$ for $n \geq 1$.

Similarly the HC - HC^- - HC^{per} exact sequence (cf. 5.1.5) splits (again $B = 0$) and there are isomorphisms

$$(7.3.9.4) \quad HC_n^-(G) \cong \prod_{i \geq n} H_{n+2i}(G) ,$$

$$(7.3.9.5) \quad HC_{2n+0 \text{ or } 1}^{\text{per}}(G) \cong \prod_{i \geq 0} H_{2i+0 \text{ or } 1}(G) .$$

In particular $H_n(G)$ is a direct factor of $HC_n^-(G)$. We will give in 7.4.8 a purely algebraic proof of these isomorphisms.

7.3.10 The Cyclic Bar Construction on Groups. Let G be a topological group. Put $\Gamma_n G = G \times \dots \times G = G^{n+1}$ (cartesian product) and define a simplicial space ΓG by

$$\begin{aligned} d_i(g_0, \dots, g_n) &= (g_0, \dots, g_{i-1}, g_i g_{i+1}, g_{i+2}, \dots, g_n) \quad \text{for } 0 \leq i < n , \\ d_n(g_0, \dots, g_n) &= (g_n g_0, g_1, \dots, g_{n-1}) , \\ s_i(g_0, \dots, g_n) &= (g_0, \dots, g_i, 1, g_{i+1}, \dots, g_n) , \end{aligned}$$

(compare with the cyclic module $C(A)$ of an algebra).

Let the action of the cyclic operator be given by

$$t_n(g_0, \dots, g_n) = (g_n, g_0, \dots, g_{n-1}) .$$

It is straightforward to check that this defines a cyclic structure on ΓG and we still denote by ΓG the resulting cyclic space which we call the *cyclic bar construction* of G .

For G discrete it is immediate that the canonical isomorphisms $k[G^n] \cong k[G]^{\otimes n}$ assemble to give an isomorphism of cyclic modules $k[\Gamma G] \cong C(k[G])$, which will be studied more algebraically later on (cf. Sect. 7.4).

Remark that we did not use the existence of an inverse in G , so this construction applies equally well to topological monoids.

The geometric realization of $\Gamma.G$ together with its circle action is described in the following

7.3.11 Theorem. *For any topological (or simplicial) group G there is a canonical homotopy equivalence from the geometric realization of the cyclic bar construction $\Gamma.G$ to the free loop space of BG :*

$$\gamma : |\Gamma.G| \rightarrow \mathcal{L}BG := \text{Map}(S^1, BG).$$

This map is S^1 -equivariant for the S^1 -structure of $|\Gamma.G|$ inherited from the cyclic space structure and for the S^1 -structure of the loop space given by multiplication in S^1 .

Note that if G is topological, then $\Gamma.G$ is a simplicial space, and if G is simplicial, then $\Gamma.G$ is a bisimplicial set.

Proof. The projection map $\text{proj} : \Gamma.G \rightarrow B.G$ onto the nerve of G , is given by $\text{proj}(g_0, \dots, g_n) = (g_1, \dots, g_n)$. It is obviously a continuous simplicial map, but it is even a continuous cyclic map provided that one puts on $B.G$ the cyclic structure of $B.(G, 1)$ as described in 7.3.3. The composite map

$$S^1 \times |\Gamma.G| \rightarrow |\Gamma.G| \xrightarrow{|\text{proj}|} |B.G|,$$

where the first map follows from the cyclic structure of $\Gamma.G$, has an adjoint which is precisely the map

$$\gamma : |\Gamma.G| \rightarrow \mathcal{L}BG$$

we are looking for. It is immediate from the construction that γ is functorial in G .

Since the projection map is cyclic, its geometric realization is S^1 -equivariant. But the S^1 -structure of $BG = |B.(G, 1)|$ is trivial (cf. 7.3.5), so the action of S^1 on $\mathcal{L}BG$ is simply by multiplication in S^1 .

In order to prove that γ is a homotopy equivalence we consider the following commutative diagram:

$$\begin{array}{ccccc} G & \rightarrow & |\Gamma.G| & \xrightarrow{|\text{proj}|} & |B.G| \\ \downarrow \bar{\gamma} & & \downarrow \gamma & & \parallel \\ \Omega BG & \rightarrow & \mathcal{L}BG & \longrightarrow & BG. \end{array}$$

The upper row is the geometric realization of the simplicial fibration of spaces $G \rightarrow \Gamma.G \rightarrow B.G$, where G (trivial simplicial group) is embedded in $\Gamma.G$ as the first coordinate. The lower row is the standard fibration with fiber the based-loop group on BG . In order to prove that γ is a homotopy equivalence it is sufficient to show that the induced map at the fiber level, denoted $\bar{\gamma}$, is a homotopy equivalence.

7.3.12 Lemma. *The fiber map $\bar{\gamma} : G \rightarrow \Omega BG$ is the classical homotopy equivalence.*

Proof. Let us first recall what the classical homotopy equivalence $G \rightarrow \Omega BG$ looks like simplicially. It is completely determined by the adjoint map $S^1 \times G \rightarrow BG$, which one can construct simplicially as follows. Let $S^1 = |C_\bullet|$ and $BG = |B_\bullet G|$, and consider G as a trivial simplicial space (i.e. G in each dimension). Then, this map is the geometric realization of the unique simplicial map which sends $(t; g) \in C_1 \times G$ to $g \in B_1 G = G$.

By definition of γ (cf. 7.3.11 and 7.1.9) its adjoint map is the composite

$$S^1 \times |\Gamma_\bullet G| \xrightarrow{(p_1, p_2)^{-1}} |F\Gamma_\bullet G| \xrightarrow{|\text{ev}|} |\Gamma_\bullet G| \xrightarrow{|\text{proj}|} |B_\bullet G|.$$

Since the restriction of $(p_1, p_2)^{-1}$ to $S^1 \times G$ is the canonical identification of $|C_\bullet| \times G$ with $|C_\bullet \times G| \subset |F\Gamma_\bullet G|$, it follows that the adjoint map of $\bar{\gamma}$ is the geometric realization of

$$C_\bullet \times G \xrightarrow{\text{inc}} C_\bullet \times \Gamma_\bullet G \xrightarrow{\text{ev}} \Gamma_\bullet G \xrightarrow{\text{proj}} B_\bullet G.$$

By definition of ev (cf. 7.1.6.ii) and proj , we get

$$\text{proj} \circ \text{ev} \circ \text{inc}(t; g) = \text{proj} \circ \text{ev} \circ (t; (g, 1)) = \text{proj}(t_*(g, 1)) = \text{proj}(1, g) = g.$$

Therefore we are done. □

7.3.13 Corollary. *For any discrete group G there are canonical isomorphisms*

$$HH_*(k[G]) \cong H_*(\mathcal{L}BG, k) \quad \text{and} \quad HC_*(k[G]) \cong H_*^{S^1}(\mathcal{L}BG, k).$$

Proof. It suffices to remark that the cyclic module $k[\Gamma_\bullet G]$ associated to the cyclic bar construction is canonically isomorphic to the cyclic module $C(k[G])$. □

Remark. The twisted nerve construction and the cyclic bar construction are intimately related. This relationship will be studied in detail in the next section.

7.3.14 Corollary. *For any reduced simplicial set X . (i.e. $X_0 = \{*\}$) we denote by ΩX the simplicial (Kan) loop group of X . Then $k[\Omega X]$ is a simplicial algebra and there are canonical isomorphisms*

$$HH_*(k[\Omega X]) \cong H_*(\mathcal{L}|X|, k) \quad \text{and} \quad HC_*(k[\Omega X]) \cong H_*^{S^1}(\mathcal{L}|X|, k).$$

Proof. The loop group ΩX is a simplicial group to which one can apply Theorem 7.3.11. Then one applies a slight variation of Theorem 7.2.10 to the

simplicial-cyclic set $\Gamma.\Omega X$. It suffices to remark that $|X|$ is a deformation retract of $B\Omega X$. \square

7.3.15 Free Loop Space. In the above corollary one can suppose that X is a connected pointed space and let ΩX be the Moore loop space of X (parametrize the loops by intervals in \mathbb{R} rather than just by $[0, 1]$, so that composition of loops becomes strictly associative). So ΩX is a topological monoid, which is group-like, that is $\pi_0(\Omega X)$ is a group. Then there is a canonical homotopy equivalence

$$|\Gamma.\Omega X| \xrightarrow{\sim} \mathcal{L}X .$$

For another cyclic construction of $\mathcal{L}(X)$ see Exercise E.7.3.9.

Exercises

E.7.3.1. Let G be a group equipped with a central element z of finite order n . Suppose that the composite map

$$\mathbb{Z}/n\mathbb{Z} \xrightarrow{1 \mapsto z} G \rightarrow G_{ab} = G/[G, G]$$

is injective (for instance G abelian). Show that $X(G, z)$ is homotopy equivalent to $BS^1 \times B(G/\{z\})$. [There is a proof in Karoubi-Villamayor [1990] based on the injectivity of S^1 in the category of abelian groups. Find another proof using 7.3.7 and the fact that the Mac Lane invariant of a crossed module is the Postnikov invariant of its geometric realization (cf. Appendix C.8).]

E.7.3.2. Identify $\mathbb{Z}/n\mathbb{Z}$ with the subgroup of n th power roots of unity in S^1 . Show that the map induced by γ on the fixed points space

$$|\Gamma.G|^{\mathbb{Z}/n\mathbb{Z}} \rightarrow (\mathcal{L}BG)^{\mathbb{Z}/n\mathbb{Z}}$$

is a homotopy equivalence (Note that this is not true if $\mathbb{Z}/n\mathbb{Z}$ is replaced by S^1) (cf. Bökstedt-Hsiang-Madsen [1992]).

E.7.3.3. Let $z \in G$ be such that z^r is central for some integer $r \geq 1$. Show that formula (7.3.3.1) defines a structure of $\Delta C(r)^{op}$ -set on the nerve of G .

E.7.3.4. Show that Theorem 7.3.10 is true for group-like topological monoids (i.e. π_0 is a group). (Construct a simplicial group model of the monoid and apply Theorem 7.3.10. Other proofs in Burghilea-Fiedorowicz [1986], Goodwillie [1985a], Jones [1987].)

E.7.3.5. Extend the results of this section to dihedral sets and spaces. In particular describe a dihedral structure on $B.G$ and identify $\|B.G\|^{dih}$ (cf. Loday [1987, §4], Lodder [1990], Krasauskas-Lapin-Solovev [1987]).

E.7.3.6. Extend the constructions and results of this section from discrete groups to small categories (cf. McCarthy [1992a]).

E.7.3.7. Show that the space $X(G, z)$ is homotopy equivalent to the classifying space $B\hat{G}(z)$ of the topological group $\hat{G}(z)$ defined by the push-out diagram

$$\begin{array}{ccc} \mathbb{Z} & \xrightarrow{z} & G \\ \downarrow & & \downarrow \\ \mathbb{R} & \longrightarrow & \hat{G}(z) . \end{array}$$

E.7.3.8. Let G be a group and let $C^{\text{sym}}(k[G])$ be the functor $\Delta S \rightarrow (k\text{-Mod})$ defined in 6.1.12. Show that there is a natural isomorphism

$$\text{Tor}_*^{\Delta S}(C^{\text{sym}}(k[G]), k) \cong H_*(\Omega\Omega^\infty S^\infty(BG), k) .$$

Show a similar result with ΔB (braid category, cf. Exercise E.6.3.1) in place of ΔS and $\Omega^2 S^2$ in place of $\Omega^\infty S^\infty$ (cf. Fiedorowicz [1992]).

E.7.3.9. For any space X let $[n] \mapsto X^{n+1}$ be the cocyclic space defined by

$$\begin{aligned} \delta_i(x_0, \dots, x_{n-1}) &= (x_0, \dots, x_i, x_i, \dots, x_{n-1}) , \quad 0 \leq i \leq n-1 , \\ \delta_n(x_0, \dots, x_{n-1}) &= (x_0, x_1, \dots, x_{n-1}, x_0) , \\ \sigma_j(x_0, \dots, x_{n+1}) &= (x_0, \dots, x_{i-1}, x_{i+1}, \dots, x_{n+1}) , \quad 0 \leq j \leq n , \\ \tau_n(x_0, \dots, x_n) &= (x_1, \dots, x_n, x_0) . \end{aligned}$$

Show that its geometric realization as a cosimplicial space is $\mathcal{L}(X)$ and that the S^1 -structure induced by the cyclic action is compatible with the standard S^1 -structure of $\mathcal{L}(X)$ (cf. Exercise E.7.2.5). Show that this functor is the restriction of a functor from ΔS . (Cf. Jones [1987].)

E.7.3.10. Let X be a connected basepointed CW -complex. Denote by ΩX the Moore loop space of X , which is a topological monoid. Let $\mathcal{S}_*(\Omega X)$ be the algebra of singular chains on ΩX with coefficients in k . Show that there is a canonical isomorphism

$$H_*^{S^1}(\mathcal{L}X) \cong HC_*(\mathcal{S}_*(\Omega X)) .$$

Deduce that for any 2-connected map $f : X \rightarrow Y$ there is an isomorphism

$$\lim_k H_{n+2k}^{S^1}(\mathcal{L}X) \cong \lim_k H_{n+2k}^{S^1}(\mathcal{L}Y) .$$

(Cf. Goodwillie [1985a, §5]. See also Burghelea-Fiedorowicz [1986].)

7.4 Hochschild Homology and Cyclic Homology of Group Algebras

In Chap. 3 we gave several examples of computations for Hochschild and cyclic homology. We continue here with the case of a group algebra $k[G]$. The reason for delaying this computation until now is because the best way of expressing the result in the characteristic free case is by using the notions of cyclic set and cyclic geometric realization.

Both Hochschild and cyclic homology of $k[G]$ split as a direct sum over the conjugation classes of G . Each term is either the homology of a discrete group (i.e. of a $K(\pi, 1)$ -space) or the homology of a space which has only π_1 and π_2 homotopy groups (cf. 7.4.5 and 7.4.7).

These results are essentially due to D. Burgelea [1985], but the proofs are slightly different.

7.4.1 Notation. Let G be a discrete group and let M be a G -bimodule (that is a $k[G]$ -bimodule). We can convert M into a right G -module \tilde{M} by the formula

$$m^g = g^{-1}mg \quad \text{for } m \in M \quad \text{and } g \in G.$$

The Hochschild homology of $k[G]$ with coefficients in M and the homology of the discrete group G with coefficients in the right module \tilde{M} (cf. Appendix C) are related by the following

7.4.2 Proposition (Mac Lane Isomorphism). *Under the above hypotheses and notation there is a canonical isomorphism*

$$\Phi_* : H_n(k[G], M) \cong H_n(G, \tilde{M}).$$

Proof. Hochschild homology is the homology of the Hochschild complex as described in 1.1.1, with module of n -chains $M \otimes k[G]^{\otimes n}$. Homology of the discrete group G with coefficients in the right module \tilde{M} is the homology of the Eilenberg-Mac Lane complex as described in Appendix C.2, with module of n -chains $\tilde{M} \otimes k[G^n]$. Using the identification $k[G]^{\otimes n} \cong k[G^n]$, the Mac Lane isomorphism of modules

$$\Phi : C(k[G], M) = M \otimes k[G]^{\otimes n} \rightarrow C(G; \tilde{M}) = \tilde{M} \otimes k[G^n]$$

is given by

$$(7.4.2.1) \quad \Phi(m, g_1, \dots, g_n) = (g_1 \dots g_n m; g_1, \dots, g_n).$$

It is immediate to check that this is a map of complexes (it is in fact a map of simplicial modules) and therefore an isomorphism of complexes. \square

7.4.3 Centralizer and Conjugation Classes. The *centralizer* of z in G is the subgroup $G_z := \{g \in G \mid zg = gz\}$. Up to isomorphism this centralizer

depends only on the conjugation class $\langle z \rangle$ of z because if two elements z and z' are conjugate, say $z' = hzh^{-1}$ for some $h \in G$, then $G_{z'}$ is isomorphic to G_z via the map $g \mapsto h^{-1}gh$. We suppose that for any conjugation class of G we have selected a particular element z in it. The set of *conjugation classes* of G is denoted $\langle G \rangle$, it is partitioned into a disjoint union $\langle G \rangle^{\text{fin}} \cup \langle G \rangle^\infty$ depending on z being of finite order or of infinite order.

We can now express the Hochschild homology of $k[G]$ in terms of the homology of discrete groups.

7.4.4 Proposition. *For any discrete group G and any element $z \in G$, let $\Gamma_n(G, z) := \{(g_0, \dots, g_n) \in G^{n+1} \mid \text{the product } g_0g_1 \dots g_n \text{ is conjugate to } z\}$. There is a canonical splitting of cyclic modules:*

$$C.(k[G]) \cong \bigoplus_{\langle z \rangle \in \langle G \rangle} k[\Gamma.(G, z)].$$

Proof. Note first that $\Gamma.(G, z)$ is a subcyclic set of $\Gamma.G = \{[n] \mapsto G^{n+1}\}$ (cf. 7.3.10) since faces, degeneracies and cyclic permutations of (g_0, \dots, g_n) do not change the conjugation class. Then the isomorphism is a consequence of the bijection

$$G^{n+1} = \Gamma_n G \cong \bigcup_{\langle z \rangle \in \langle G \rangle} \Gamma_n(G, z). \quad \square$$

7.4.5 Definition-Proposition. *The natural inclusion $\iota : B.(G_z, z) \hookrightarrow \Gamma.(G, z)$ given by $\iota(g_1, \dots, g_n) := ((g_1g_2 \dots g_n)^{-1}z, g_1, \dots, g_n)$, is a map of cyclic sets which induces an isomorphism on homology (of the underlying simplicial sets).*

Proof. From the simplicial structure of $B.(G_z, z)$ (nerve of G_z) and the simplicial structure of $\Gamma.(G, z)$ (cf. 7.3.10) it is immediate that the inclusion is simplicial. The action of the cyclic operator is given by

$$t_n((g_1g_2 \dots g_n)^{-1}z, g_1, \dots, g_n) = (g_n, (g_1g_2 \dots g_n)^{-1}z, g_1, \dots, g_{n-1}),$$

which is precisely the image of $t_n(g_1, \dots, g_n) = (z(g_1g_2 \dots g_n)^{-1}, g_1, \dots, g_{n-1})$ by ι . So ι is a map of cyclic sets.

At the simplicial module level there is a factorization of ι as

$$k[B.G_z] = C(G_z, k) \xrightarrow{\alpha} C(G, k[\langle z \rangle]) \xrightarrow{\Phi^{-1}} k[\Gamma.(G, z)],$$

where $\alpha(g_1, \dots, g_n) = (z; g_1, \dots, g_n)$. The module $k[\langle z \rangle]$ is induced by the inclusion map $G_z \hookrightarrow G$ from the trivial G_z -module k . Therefore Shapiro's lemma (cf. Appendix C.9) implies that α is a quasi-isomorphism. Then the proposition is a consequence of 7.4.2. □

7.4.6 Theorem. *For any discrete group G and any integer $n \geq 0$, there are canonical isomorphisms*

$$HH_n(k[G]) \cong \bigoplus_{\langle z \rangle \in \langle G \rangle} H_n(k[B.(G_z, z)]) = \bigoplus_{\langle z \rangle \in \langle G \rangle} H_n(G_z),$$

$$HC_n(k[G]) \cong \bigoplus_{\langle z \rangle \in \langle G \rangle} HC_n(k[B.(G_z, z)]),$$

and similarly for HC^{per} and HC^- .

Proof. These assertions follow immediately from Propositions 7.4.4 and 7.4.5. Note that the ordinary homology of a cyclic module depends only on the simplicial structure, whence the equality at the Hochschild level. \square

7.4.7 Relationship with Cyclic Homology of a Discrete Group.

Consider the nerve of a group as a cyclic set by $B.G = B.(G, 1)$. Then by definition

$$HC_n(G) := HC_n(k[B.G]), \quad HC_n^-(G) := HC_n^-(k[B.G]),$$

$$HC_n^{\text{per}}(G) := HC_n^{\text{per}}(k[B.G]).$$

It is clear from Theorem 7.4.6 that

$$H_n(G) := H_n(k[B.G]) = H_n(k[B.(G_1, 1)])$$

is the $\langle 1 \rangle$ -component of $HH_n(k[G])$ and so a direct factor. Here are similar results for the other theories.

7.4.8 Proposition. *The $\langle 1 \rangle$ -component of $HC_n(k[G])$ (resp. $HC_n^-(k[G])$, resp. $HC_n^{\text{per}}(k[G])$) is $HC_n(G)$ (resp. $HC_n^-(G)$, resp. $HC_n^{\text{per}}(G)$). There are canonical isomorphisms*

$$HC_n(G) \cong \bigoplus_{i \geq 0} H_{n-2i}(G),$$

$$HC_n^-(G) \cong \prod_{i \geq 0} H_{n+2i}(G),$$

$$HC_n^{\text{per}}(G) \cong \prod_{i \in \mathbb{Z}} H_{n+2i}(G).$$

In particular, in each case $H_n(G)$ is a direct factor.

Proof. The first assertion is an immediate consequence of Proposition 7.4.5 for $z = 1$ and of Proposition 7.4.4. Note that, for $z = 1$, the inclusion ι is an isomorphism.

Let us first prove the second assertion for the functor HC_n . Consider the cyclic set $E.G$ (cf. Appendix B.12), where the cyclic structure is given by

$$t_n(g_0, g_1, \dots, g_n) = (g_n, g_0, g_1, \dots, g_{n-1}).$$

The bicomplex $CC(k[E.G])$ is a free resolution of the trivial G -complex

$$(7.4.8.1) \quad k \rightarrow 0 \rightarrow k \rightarrow 0 \rightarrow \dots ,$$

and its tensor product with the trivial G -module k is

$$CC(k[E.G]) \otimes_{k[G]} k = CC(k[B.G]) .$$

However there is another free resolution of the complex (7.4.8.1). It consists in taking $C(E.G)$ for the even columns and 0 for the odd columns. The tensor product of this new bicomplex with the trivial G -module k gives the bicomplex

$$C(k[B.G]) \leftarrow 0 \leftarrow C(k[B.G]) \leftarrow 0 \leftarrow \dots$$

The comparison of these two resolutions gives rise to a quasi-isomorphism

$$\text{Tot } CC(k[B.G]) \rightarrow C(k[B.G]) \oplus C(k[B.G])[2] \oplus \dots$$

Hence $HC_*(G) := HC_*(k[B.G]) = H_*(G) \oplus H_*(G)[2] \oplus H_*(G)[4] \oplus \dots$. This ends the computation of $HC_n(G)$ (Compare with Exercise E.7.4.8).

For HC^- and HC^{per} one replaces CC by CC^- and CC^{per} respectively. Then the complex (7.4.8.1) is replaced by the complexes

$$(7.4.8.2) \quad \dots \rightarrow 0 \rightarrow k \rightarrow 0 \rightarrow k ,$$

$$(7.4.8.3) \quad \dots \rightarrow k \rightarrow 0 \rightarrow k \rightarrow 0 \rightarrow \dots ,$$

respectively, whence the assertions. □

7.4.9 The Space $X(G_z, z)$. The element z is central in G_z , so the map $\gamma_z : \mathbb{Z} \times G_z \rightarrow G_z, \gamma_z(n, g) = z^n g$, is a group homomorphism which gives rise to a map $B\gamma_z : S^1 \times BG_z \rightarrow BG_z$. This is in fact an S^1 -action on BG_z and the space $X(G_z, z)$ is by definition (cf. 7.3.5) the Borel space

$$X(G_z, z) := ES^1 \times_{S^1} BG_z .$$

Recall that $\pi_1(X(G_z, z)) = G_z/\{z\}$ and

$$\pi_2(X(G_z, z)) \cong \begin{cases} \mathbb{Z} & \text{if } z \text{ is of finite order,} \\ 0 & \text{if } z \text{ is of infinite order.} \end{cases}$$

In particular, in the second case, one has $X(G_z, z) = B(G_z/\{z\})$.

7.4.10 Theorem. *For any discrete group G and any integer $n \geq 0$, there is a canonical isomorphism*

$$\begin{aligned} HC_n(k[G]) &\cong \bigoplus_{\langle z \rangle \in \langle G \rangle} H_n(X(G_z, z), k) \\ &= \bigoplus_{\langle z \rangle \in \langle G \rangle^\infty} H_n(G_z/\{z\}) \oplus \bigoplus_{\langle z \rangle \in \langle G \rangle^{\text{fin}}} H_n(X(G_z, z), k) , \end{aligned}$$

where $X(G_z, z)$ is the space described above.

Proof. By Proposition 7.3.4 the cyclic geometric realization of $B.(G_z, z)$ is the space $X(G_z, z)$. So by Theorem 7.2.3 and by 7.3.5 we get the following sequence of isomorphisms:

$$HC_*(k[B.(G_z, z)]) \cong H_*(|B.(G_z, z)|^{cy}, k) \cong H_*(X(G_z, z), k).$$

Taking the composite and applying Theorem 7.4.6 finishes the proof. \square

7.4.11 Corollary. *If G is a torsion free group, then there is an isomorphism of graded modules*

$$HC_*(k[G]) \cong \bigoplus_{\substack{(z) \in \langle G \rangle \\ z \neq 1}} H_*(G_z/\{z\}) \oplus H_*(BS^1 \times BG, k),$$

which is equivalent to

$$HC_n(k[G]) \cong \bigoplus_{\substack{(z) \in \langle G \rangle \\ z \neq 1}} H_n(G_z/\{z\}) \oplus H_n(G) \oplus H_{n-2}(G) \oplus \dots$$

Proof. Since G is torsion free the only element of $\langle G \rangle^{\text{fin}}$ is 1. In this case $X(G_1, 1) = BS^1 \times BG$ (cf. 7.3.9), whence the assertion. \square

7.4.12 Corollary. *If G is abelian, then there is an isomorphism of graded modules*

$$HC_*(k[G]) \cong \bigoplus_{(z) \in \langle G \rangle^\infty} H_*(G/\{z\}) \oplus (HC_*(k) \otimes \left(\bigoplus_{(z) \in \langle G \rangle^{\text{fin}}} H_*(G/\{z\}) \right)).$$

Proof. This is a consequence of Theorem 7.4.10 and Proposition 7.3.7. \square

7.4.13 Corollary. *If k contains \mathbb{Q} , then there is an isomorphism of graded modules*

$$HC_*(k[G]) \cong \bigoplus_{(z) \in \langle G \rangle^\infty} H_*(G_z/\{z\}) \oplus \left(HC_*(k) \otimes \left(\bigoplus_{(z) \in \langle G \rangle^{\text{fin}}} H_*(G_z/\{z\}) \right) \right).$$

Proof. This is a consequence of Theorem 7.4.10 and Proposition 7.3.8. \square

7.4.14 Comment on the Proof of Theorem 7.4.10. The statements of Corollaries 7.4.12 and 7.4.13 are purely algebraic and one can easily give a purely algebraic proof of them. However, for Theorem 7.4.10 it seems a priori impossible to give a purely algebraic proof since the result involves a space with π_1 and π_2 . In fact one can define algebraically the homology of a crossed module (see Appendix C.8) and one can replace in 7.4.10 the homology of $X(G_z, z)$ by the homology of the crossed module $z : \mathbb{Z} \rightarrow G_z$. Under this modification one can provide a purely algebraic proof of 7.4.10.

7.4.15 Proposition. *Under the isomorphisms of Theorems 7.4.2 and 7.4.10 Connes periodicity exact sequence is the direct sum over $\langle z \rangle \in \langle G \rangle$ of the Gysin sequences associated to the homotopy fibrations*

$$S^1 \rightarrow BG_z \rightarrow X(G_z, z).$$

Proof. This is an immediate consequence of the splitting of cyclic modules described in 7.4.4 and part b) of Theorem 7.2.3. □

Exercises

E.7.4.1. Compute HD and HQ of a group algebra. (Cf. Loday [1987, §4]).

E.7.4.2. Extend the method of this section to the computation of HH and HC of $k[M]$ where M is a monoid.

E.7.4.3. Twisted Group Algebra. Let A be a k -algebra, G a group and α a homomorphism from G into $\text{Aut}(A)$. Write a^g for the action of $g \in G$ on $a \in A$. The twisted group algebra $A_\alpha[G]$ is the free A -module $A[G]$ equipped with the product $(ag)(bh) = (ab^g)(gh)$. Show that $HC_*(A_\alpha[G])$ admits a direct sum decomposition over the conjugation classes of G and compute the components. (Cf. Feigin-Tsygan [FT], Burghilea-Fiedorowicz [1986].)

E.7.4.4. Hochschild Homology of Hopf Algebras. Let A be a Hopf algebra over k with antipodal map S (cf. Appendix A.2). Let m_r (resp. m_l) be the right action of A on itself, i.e. $m_r(a)b = ba$ (resp. $m_l(a)b = ab$). Define a right action ϱ of A on itself (conjugation) by $\varrho(a) = (m_r \otimes m_l)(1 \otimes S)\Delta(a)$. Define a complex $(C(A), d)$ by $C_n(A) = A^{\otimes n+1}$ and

$$d(a_0, \dots, a_n) = (\varrho(a_1)a_0, a_2, \dots, a_n) + \sum_{i=1}^{n-1} (-1)^i (a_0, \dots, a_i a_{i+1}, \dots, a_n) + (-1)^n (c(a_n)a_0, \dots, a_{n-1}),$$

(c is the co-unit of the Hopf algebra).

Show that for $A = k[G]$, $S(g) = g^{-1}$, this is the Eilenberg-Mac Lane complex. Show that there is an isomorphism of complexes $\Phi : (C(A), b) \rightarrow (C(A), d)$. Apply this result to the computation of Hochschild and cyclic homology of $U(\mathfrak{g})$, ΛV , quantum groups. (Cf. Feigin-Tsygan [FT] and Feng-Tsygan [1992].)

E.7.4.5. Let G^c be the G -set G equipped with the action by conjugation. Show that there is a natural homotopy equivalence $\mathcal{L}BG \cong EG \times_G G^c$. Deduce from this statement and from Corollary 7.3.13 the splitting of HH_* and HC_* of $k[G]$.

E.7.4.6. Show that under the isomorphism of Theorem 7.4.6 the map $B_* : HH_*(k[G]) \rightarrow HH_{*+1}(k[G])$ is the sum of the maps $B_*^z : HH_*(G_z) \rightarrow$

$HH_{*+1}(G_z)$, $B_*^z(x) = (\gamma_z)_*(x \cup u)$ where u is the standard generator of $H_1(\mathbb{Z})$.

E.7.4.7. Find explicit quasi-isomorphisms (and homotopies) between the complexes $\text{Tot } CC(G)$ and $\bigoplus_{i \geq 0} C(G)[2i]$ on one hand, and $\text{ToT } CC^-(G)$ and $\prod_{i \geq 0} C(G)[-i]$ on the other hand. (Use the “killing contractible complexes” Lemma, cf. 2.1.6.)

E.7.4.8. Show that there exist functorial maps $\alpha : k[G^n] \rightarrow k[G^{n+2}]$, $n \geq 0$, satisfying $\alpha b + b\alpha = B$. Deduce from α the existence of an isomorphism of mixed complexes

$$(C(G), b, B) \rightarrow (C(G), b, 0),$$

and therefore a new proof of Proposition 7.4.8. (Cf. Karoubi [1987], p.80).

Bibliographical Comments on Chapter 7

The idea of looking at cyclic sets and cyclic spaces originates from Connes paper [1983], from the example of group algebras and also from constructions in algebraic K -theory. The study of the geometric realization of cyclic spaces, the comparison with S^1 -equivariant homology and with the Gysin sequence, and the relationship with the free loop space come from Burghelea-Fiedorowicz [1986], Goodwillie [1985a], Jones [1987]. See also Carlsson-Cohen [1987] and Vigué-Poirrier-Burghelea [1985]. In fact the cyclic structure in the free loop space construction can already be traced in the work of Waldhausen [1978, 1984] and of Witten. Our technique of proof follows Fiedorowicz-Loday [1991].

The computation of HC of group algebras is due to Burghelea [1985]. Partial results appeared in Karoubi [1983]. A purely algebraic translation in characteristic zero was done in Marciniak [1985]. A generalization to real and p -adic Lie groups, with application to the “abstract Selberg principle” is due to Blanc and Brylinski [1992].

Chapter 8. Chern Character

One of the main themes of differential topology is: characteristic classes. The point is to define invariants of a topological or differentiable situation and then to calculate them. Many interesting invariants lie in the so-called K -groups. In the case of manifolds, for instance, these invariants are computed via the “Chern character”, which maps K -theory to the de Rham cohomology theory.

In his study of foliations Alain Connes needed such a Chern character map in order to compute the invariants lying in the K -theory of the Banach algebra associated to the foliation. These Banach algebras are not commutative in general and the classical theory does not work anymore. In order to achieve this construction he invented a new theory to play the role of de Rham cohomology and constructed a Chern character with values in it. This new theory is, as one can guess, cyclic homology and the construction of the Chern character in this framework is the main purpose of this chapter.

In the first section we recall the classical construction of the Chern character using connections. Our treatment is purely algebraic: for any finitely generated projective module over A there is defined an element in the de Rham homology of A .

In the second section we introduce the Grothendieck group of a ring and show that the construction of the preceding section can be interpreted as a natural transformation of functors (Chern character)

$$K_0 \rightarrow H_{\text{DR}}^{\text{ev}} .$$

These two sections are classical matter.

Section 8.3 deals with the generalization due to Connes of this Chern character in the non-commutative case. Then de Rham homology has to be replaced by cyclic homology. In fact the best receptacle, as shown by J.D.S. Jones, is *negative* cyclic homology:

$$\text{ch}_0^- : K_0 \rightarrow HC_0^- .$$

Composition on the right with the natural map from negative cyclic homology to cyclic homology gives rise to Chern characters with values in HC_{2i} , for all i . There are several advantages in lifting this Chern characters to HC^- . One of them is the nice behavior of ch^- with the product structure.

Section 8.4 consists in generalizing this transformation by putting n instead of 0:

$$\text{ch}_n^- : K_n \rightarrow HC_n^- .$$

Higher algebraic K -theory will only be introduced in Chap. 10 and what we really perform in this section is the construction of a natural map

$$\text{ch}_n^- : H_n(GL(A)) \rightarrow HC_n^-(A) , \quad n \geq 1 .$$

The former map is obtained by composition with the Hurewicz homomorphism. Composition on the right with maps landing in $HC_{n+2i}(A)$ gives invariants with values in cyclic homology (as first constructed by M. Karoubi). The generalization from ch_0 to ch_n is far from being straightforward. In fact it uses a completely different technique which goes back to an idea of Keith Dennis, called Dennis trace map. For this we also need a little bit of knowledge about cyclic homology of group algebras.

The last section (Sect. 8.5) is concerned with applications to the Bass trace conjecture (due to B. Eckmann) and to the idempotent conjecture as done by A. Connes.

Standing Assumptions. In this section A is always commutative.

8.1 The Classical Chern Character à la Chern-Weil

Classically the Chern character of a vector bundle on a manifold is an element in the de Rham cohomology of this manifold. Translated algebraically the Chern character of a finitely generated projective (f.g.p.) module over A is an element of the de Rham cohomology of A . Here we construct this Chern character by starting with a connection on the f.g.p. module: this is the Chern-Weil method.

Standing Assumption. In this section we suppose that k contains \mathbb{Q} and that A is commutative and unital.

8.1.1 Connections. Let A be a unital commutative k -algebra and M an A -module (mostly considered as a right module). By definition a *connection* on the A -module M is a k -linear map

$$\nabla : M \otimes_A \Omega_{A|k}^n \rightarrow M \otimes_A \Omega_{A|k}^{n+1}$$

defined for all $n \geq 0$ and such that

$$(8.1.1.1) \quad \begin{aligned} \nabla(x\omega) &= (\nabla x)\omega + (-1)^n x d\omega , \\ \text{for } x &\in M \otimes_A \Omega_{A|k}^n \quad \text{and} \quad \omega \in \Omega_{A|k}^p . \end{aligned}$$

Note that ∇ is completely determined by its restriction to $M = M \otimes_A \Omega_{A|k}^0$, that is $\nabla : M \rightarrow M \otimes_A \Omega_{A|k}^1$ which satisfies

$$(8.1.1.2) \quad \nabla(ma) = (\nabla m)a + mda, \quad \text{for } m \in M \text{ and } a \in A.$$

8.1.2 Proposition-Definition. *The composite $\nabla^2 = \nabla \circ \nabla : M \otimes_A \Omega_{A|k}^* \rightarrow M \otimes_A \Omega_{A|k}^{*+2}$ is $\Omega_{A|k}^*$ -linear. In particular its restriction to M , denoted $R : M \rightarrow M \otimes_A \Omega_{A|k}^2$ and called the curvature of ∇ , is A -linear and satisfies*

$$\nabla^2(m \otimes \omega) = R(m)\omega \quad \text{for } m \in M \text{ and } \omega \in \Omega_{A|k}^*.$$

Proof. One has

$$\begin{aligned} \nabla \circ \nabla(x\omega) &= \nabla \left(\nabla(x)\omega + (-1)^{|x|}x d\omega \right) \\ &= \nabla^2(x)\omega + (-1)^{|x|+1}\nabla(x)d\omega + (-1)^{|x|}\nabla(x)d\omega + x d^2\omega \\ &= \nabla^2(x)\omega. \end{aligned}$$

This proves that ∇^2 is $\Omega_{A|k}^*$ -linear. The particular case $x = m$ gives the second formula. □

8.1.3 The Case M Projective. Suppose that M is free over A . Then an A -linear map $M \rightarrow M \otimes_A \Omega_{A|k}^*$ is nothing but a matrix with coefficients in $\Omega_{A|k}^*$ or, in other words, an element of $\text{End}_A(M) \otimes_A \Omega_{A|k}^*$. Since a projective module is a direct summand of a free module (see 8.2.1), the same is true when M is projective. Therefore, when M is projective, R can be viewed as an element of $\text{End}_A(M) \otimes_A \Omega_{A|k}^2$. Moreover under this hypothesis the connection ∇ on M defines a connection $[\nabla, -]$ on $\text{End}_A(M)$ by $[\nabla, -](\alpha) = [\nabla, \alpha] = \nabla\alpha - \alpha\nabla$ where $\alpha \in \text{End}_A(M) \otimes_A \Omega_{A|k}^n$ is viewed as a map $M \rightarrow M \otimes_A \Omega_{A|k}^n$. This connection has the following property.

8.1.4 Lemma. $[\nabla, R] = 0$.

Proof. Since $R \in \text{End}_A(M) \otimes_A \Omega_{A|k}^2$ the expression $[\nabla, R]$ makes sense and

$$[\nabla, R] = \nabla \circ R - R \circ \nabla = \nabla \circ \nabla^2 - \nabla^2 \circ \nabla = \nabla^3 - \nabla^3 = 0. \quad \square$$

8.1.5 Lemma. *If M is a f.g.p. A -module, then there is a commutative diagram*

$$\begin{array}{ccc} \text{End}_A(M) \otimes_A \Omega_{A|k}^* & \xrightarrow{[\nabla, -]} & \text{End}_A(M) \otimes_A \Omega_{A|k}^{*+1} \\ \text{tr} \otimes \text{id} \downarrow & & \downarrow \text{tr} \otimes \text{id} \\ \Omega_{A|k}^* & \xrightarrow{d} & \Omega_{A|k}^{*+1} \end{array}$$

where d is the exterior differential.

Proof. Note that the trace homomorphism tr is well-defined because M is f.g.p. (see 8.2.1 for the definition). It obviously suffices to prove the commutativity when M is a free finite dimensional module. Then, by induction on the dimension of M , it suffices to treat the case $M = A$. In this case $\nabla(a) = a\nabla(1) + da$ for some element $\nabla(1) \in \Omega_{A|k}^1$. Since both $[\nabla, -]$ and d are $\Omega_{A|k}^*$ -linear (and also $\text{tr} : \text{End}_A(A) \otimes_A \Omega_{A|k}^* \cong \Omega_{A|k}^*$) it suffices to compute $[\nabla, a]$ for $a \in A = \Omega_{A|k}^0$. It comes out

$$[\nabla, a] = \nabla(a) - a\nabla(1) = a\nabla(1) + da - a\nabla(1) = da. \quad \square$$

8.1.6 Proposition. *The homogeneous component of degree $2n$ of $\text{ch}(M, \nabla) := \text{tr}(\exp(R))$ is a cycle in $\Omega_{A|k}^{2n}$.*

Proof. By $\exp(R)$ we mean the series

$$\text{id} + R + R^2/2! + \dots + R^n/n! + \dots \in \prod_n \text{End}_A(M) \otimes_A \Omega_{A|k}^{2n}.$$

Lemma 8.1.5 and Lemma 8.1.4 imply

$$d(\text{tr}(\exp(R))) = [\nabla, \exp(R)] = 0. \quad \square$$

This proposition implies that $\text{ch}(M, \nabla)$ defines a cohomology class in the de Rham cohomology of A .

8.1.7 Theorem-Definition. *The cohomology class of $\text{ch}(M, \nabla) := \text{tr}(\exp(R))$ is independent of the connection ∇ and defines an element*

$$\text{ch}(M) \in \prod_{n \geq 0} H_{\text{DR}}^{2n}(A)$$

which is called the “Chern character” of the f.g.p. A -module M .

Proof. Let ∇_0 and ∇_1 be two connections on M over A . Denote by ∇'_i the extension of ∇_i to $M[t] = M \otimes_A A[t]$ over $A[t]$. Then $\nabla'_t := t\nabla'_1 + (1-t)\nabla'_0$ is a connection on the $A[t]$ -module $M[t]$. The two projections $p_i : A[t] \rightarrow A$, $p_i(t) = i$, $i = 0$ or 1 , induce isomorphisms $(p_i)_* : H_{\text{DR}}^*(A[t]) \cong H_{\text{DR}}^*(A)$. The image of $\text{ch}(M[t], \nabla'_i)$ under $(p_i)_*$ is $\text{ch}(M, \nabla_i)$. Since $(p_0)_*^{-1} \circ (p_1)_*$ is the identity of H_{DR}^* (homotopy invariance of de Rham homology), one gets $\text{ch}(M, \nabla_0) = \text{ch}(M, \nabla_1)$. \square

8.1.8 The Levi-Civita Connection. In order for the Chern character to be really defined, one needs to show that any f.g.p. module M over A possesses a connection. If M is given by an idempotent $e \in \mathcal{M}_n(A)$ for some n , then one can define a connection as follows.

If M is free of dimension 1, i.e. $M = A$, then the exterior differential operator d is a connection. More generally if M is free of dimension r , say $M = A^r$, then

$$M \otimes_A \Omega_A^* \cong (\Omega_A^*)^r \quad \text{and} \quad (d, d, \dots, d) : (\Omega_A^*)^r \rightarrow (\Omega_A^{*+1})^r$$

is a connection for A^r .

Let e be an idempotent in $\mathcal{M}_r(A)$ and let $M = \text{Im } e$ be its image (which is a f.g.p. module) so that A^r splits as $M \oplus \text{Im}(1 - e)$. Then, from the connection on A^r that we just defined, we can extract a connection on M through the following composition:

$$M \otimes_A \Omega_A^* \hookrightarrow A^r \otimes_A \Omega_A^* \xrightarrow{(d, \dots, d)} A^r \otimes_A \Omega_A^{*+1} \xrightarrow{e \otimes id} M \otimes_A \Omega_A^{*+1} .$$

This connection on $M = \text{Im } e$, denoted ∇_e , is called the *Levi-Civita connection* by analogy with the classical situation in differential geometry.

Explicitly one sees by direct inspection that if $e \in \mathcal{M}_n(A)$, then for the Levi-Civita connection ∇_e one has

$$(8.1.8.1) \quad \text{ch}(\text{Im } e, \nabla_e) = \frac{1}{n!} \text{ class of } \text{tr}(edede \dots de) \in \Omega_{A|k}^{2n} .$$

8.2 The Grothendieck Group K_0

The best way to interpret the nice properties of the Chern character is to interpret it as a map

$$\text{ch}_0 : K_0(A) \rightarrow H_{\text{DR}}^{\text{ev}}(A)$$

where $K_0(A)$ is the Grothendieck group of the ring A . This group is the first of a family called *algebraic K-theory*, some rudiments of which will be given in Chap. 11.

The last part of this section deals with vector bundles over spaces.

8.2.1 Finitely Generated Projective Modules. A finite dimensional free module over the ring A is an A -module (let say left A -module) isomorphic to A^n for some integer n . A *finitely generated projective* (f.g.p.) module P over A is a direct summand of a finite dimensional free module. It can be described, up to isomorphism, by an idempotent e ($e^2 = e$) in $\text{End}_A(A^n) = \mathcal{M}_n(A)$, $P \cong \text{Im } e$. Remark that $\text{Im}(1 - e)$ is also a f.g.p. module and $\text{Im}(1 - e) \oplus \text{Im } e$ is isomorphic to A^n .

8.2.2 The Grothendieck Group $K_0(A)$ of Projective Modules Over A . Let $[P]$ denote the isomorphism class of the (left) f.g.p. module P . If P is isomorphic to P' , then $[P] = [P']$. Consider the free abelian group on the set of isomorphism classes $[P]$ factored out by the *Grothendieck group relation*

$$[P] + [P'] \approx [P \oplus P'] \quad \text{for all pairs } P, P' .$$

By definition this quotient is the *Grothendieck group* of the ring A and is denoted $K_0(A)$. Any element of $K_0(A)$ can be represented by a difference $[P] - [Q]$. In fact Q may even be taken to be free. Note that we did not assume A to be commutative in this definition.

It is immediate to check that if A is a field (or even a local ring) or $A = \mathbb{Z}$, then the rank map induces an isomorphism $K_0(A) \cong \mathbb{Z}$. It is also immediate that K_0 is a functor from the category of rings to the category of abelian groups.

Note also that the tensor product over A induces a ring structure on $K_0(A)$ when A is commutative. There is an extensive literature on the Grothendieck group functor (see for instance Bass [1968], Milnor [1974], or Magurn [1984]) and we will only mention the interpretation of $K_0(A)$ when A is the ring $\mathcal{C}_{\mathbb{C}}(X)$ of continuous complex functions on a topological space X at the end of the section.

8.2.3 The Classical Chern Character Map. In the previous section we constructed for each f.g.p. module M a Chern character $\text{ch}(M)$. One can in fact turn this construction into a map from the Grothendieck group of A to the de Rham homology group of A as follows.

8.2.4 Theorem. *For any commutative and unital k -algebra A (where $k \supset \mathbb{Q}$) the Chern character defines a ring homomorphism*

$$\text{ch}_0 : K_0(A) \rightarrow H_{\text{DR}}^{\text{ev}}(A) .$$

Proof. We need to verify the following properties for the Chern character:

- (1) $\text{ch}(M) = \text{ch}(M')$ if M and M' are isomorphic,
- (2) $\text{ch}(M_1 \oplus M_2) = \text{ch}(M_1) + \text{ch}(M_2)$,
- (3) $\text{ch}(M_1 \otimes M_2) = \text{ch}(M_1)\text{ch}(M_2)$.

Property (1) is a consequence of the commutativity of the diagram

$$\begin{array}{ccc} \text{End}_A(M) \otimes_A \Omega_{A|k}^* & \longrightarrow & \text{End}_A(M') \otimes_A \Omega_{A|k}^* \\ \text{tr} \downarrow & & \downarrow \text{tr} \\ \Omega_{A|k}^* & \xrightarrow{\text{id}} & \Omega_{A|k}^* \end{array}$$

which follows from the invariance of the trace under conjugation.

Property (2) follows from the fact that the Levi-Civita connection of a direct sum is the direct sum of the Levi-Civita connections, and the fact that the trace transforms \oplus into $+$.

Property (3) is left as an exercise to the reader.

In fact a proof will follow from Proposition 8.3.8 once $HC_*^-(A)$ is identified with $H_{\text{DR}}^{\text{ev}}(A)$ when A is smooth (cf. 5.1.12). □

8.2.5 Grothendieck Group of Vector Bundles. The isomorphism classes $[E]$ of complex vector bundles E over a topological paracompact space X generate an abelian group whose quotient by the relation

$$[E] + [E'] \approx [E \oplus E'] \quad \text{for all pairs of vector bundles } E, E',$$

where \oplus means direct sum of vector bundles, is denoted $K^0(X)$ and called the *Grothendieck group of vector bundles over X* . Taking the space of sections of a vector bundle over X provides a f.g.p. module over the algebra of complex functions $\mathcal{C}_{\mathbb{C}}(X)$. This assignment yields an isomorphism (Serre-Swan theorem):

$$K^0(X) \cong K_0(\mathcal{C}_{\mathbb{C}}(X)).$$

(See for instance Karoubi [1978].)

8.2.6 Chern Character for Smooth Varieties. Let $k = \mathbb{C}$ (complex numbers) and let X be a compact smooth manifold. Then one can prove that $K_0(\mathcal{C}_{\mathbb{C}}(X)) = K_0(\mathcal{C}^{\infty}(X))$. By the de Rham theorem there is a canonical isomorphism

$$H_{\text{DR}}^*(\mathcal{C}^{\infty}(X)) \cong H^*(X, \mathbb{C}),$$

and therefore the Chern character can be reinterpreted as a ring map

$$\text{ch} : K^0(X) \rightarrow H^*(X, \mathbb{C}).$$

In fact this map can be constructed for more general spaces than manifolds (paracompact spaces) by other means (since de Rham theory is not available anymore for general paracompact spaces). For instance one can use the fact that K^0 is a representable functor, $K^0(X) \cong [X, \mathbb{Z} \times BU]$ (homotopy classes of maps). Then one uses the computation of the cohomology of the infinite Grassmanian $BU = \lim_n BU(n)$ (cf. Milnor-Stasheff [1974]). One should note that in general the normalization chosen in the manifold framework is slightly different, the most common choice is to take $\exp(R/2\pi i)$ to construct the Chern character.

Exercises

E.8.2.1. Show that for any k -algebra A the groups $HH_n(A)$ and $HC_n(A)$ are modules over $K_0(A)$. (It is another interpretation of the Morita invariance, see 1.2.7 and 2.2.9.)

E.8.2.2. Show that $K_0(A) \cong \mathbb{Z}$ for any local ring A (any f.g.p. module over a local ring is free).

8.3 The Chern Character from K_0 to Cyclic Homology

The Grothendieck group is defined for any ring, not necessarily commutative. We already mentioned that cyclic homology is close to de Rham homology and defined for not necessarily commutative algebras. So the natural problem is to extend ch_0 to this setting.

We first treat the easiest case, that is H_{2n}^λ . Then we show that this Chern map $K_0 \rightarrow H_{2n}^\lambda$ comes in fact from a Chern map $K_0 \rightarrow HC_{2n}$. But, better than that, this map can be lifted to HC_0^{per} and even to HC_0^- . In other words there is defined a natural transformation of functors

$$\text{ch}_0^- : K_0 \rightarrow HC_0^- ,$$

which respects the product structure. Of course in the commutative case it lifts the classical Chern character.

Interpreted in the cohomological framework these Chern maps give rise to the original pairings

$$K_0(A) \times HC^{2n}(A) \rightarrow k$$

constructed by A. Connes [C].

8.3.1 The Chern Character for K_0 with Values in H^λ . Let k be a commutative ring in which 2 is regular (for instance $k = \mathbb{Z}$ or 2 is invertible) and let A be a unital k -algebra. Let e be an idempotent in the matrix ring $R := \mathcal{M}_r(A)$. The image of the chain $e^{\otimes n+1} = e \otimes \dots \otimes e \in C_n(R) = R^{\otimes n+1}$ by the Hochschild boundary b is either 0 (for n even) or $e^{\otimes n}$ (for n odd) since $e^2 = e$. Suppose now that we are working in $C_n^\lambda(R) = R^{\otimes n+1}/(1-t)$ where t is the cyclic operator. Then, it is immediate that $e^{\otimes n} = (-1)^{n-1}e^{\otimes n}$ in $C_{n-1}^\lambda(R)$ and so $e^{\otimes n} = 0$ when n is odd (because 2 is regular). So we have proved that for n even $e^{\otimes n+1}$ is a cycle in $C_n^\lambda(R)$. Applying the generalized trace map defined in 1.2.1 and 2.2.8–9 yields elements in $C_*^\lambda(A)$.

8.3.2 Theorem. *If 2 is regular in k , then the map $\text{ch}_{0,n}^\lambda : K_0(A) \rightarrow H_{2n}^\lambda(A)$, given by $\text{ch}_{0,n}^\lambda([e]) = \text{tr}((-1)^n e^{\otimes 2n+1})$, is well-defined and functorial in A .*

Proof. It is sufficient to prove that the map $K_0(A) \rightarrow H_{2n}^\lambda(\mathcal{M}(A))$ is well-defined and functorial since the trace map is already available (cf. 2.2.10).

First one needs to check that if the idempotents e and e' determine isomorphic f.g.p. modules, then $e^{\otimes 2n+1}$ and $e'^{\otimes 2n+1}$ have the same class in $HC_{2n}(R)$. This is a consequence of Corollary 4.1.3 since for $e, e' \in R$ with the same isomorphism class there exists $\alpha \in R^\times = GL_r(A)$ such that $e' = \alpha e \alpha^{-1}$.

Let us now verify that the Grothendieck group relation is fulfilled in $H_{2n}^\lambda(\mathcal{M}(A))$. For $e, e' \in R$ the direct sum $e \oplus e'$ can be written $e \oplus 0 + 0 \oplus e'$ in $\mathcal{M}_{2r}(A) = \mathcal{M}_2(R)$. The trace map $C_{2n}(\mathcal{M}_2(R)) \rightarrow C_{2n}(R)$ sends

$(e \oplus e')^{\otimes 2n+1}$ to $e^{\otimes 2n+1} + e'^{\otimes 2n+1}$ since the 2×2 -matrix $e \oplus e'$ has non-zero entries only in positions (1,1) and (2,2). This proves that in $H_{2n}^\lambda(\mathcal{M}(A))$ one has the equality

$$(e \oplus e')^{\otimes 2n+1} = e^{\otimes 2n+1} + e'^{\otimes 2n+1} .$$

Functoriality is immediate from the construction. □

At the expense of including some normalization coefficients one can lift this Chern character to $HC_{2n}(A)$ as follows.

8.3.3 Lemma-Notation. *For any idempotent $e \in \mathcal{M}(A)$ let*

$$y_i := (-1)^i \frac{(2i)!}{i!} e^{\otimes 2i+1} \in \mathcal{M}(A)^{\otimes 2i+1}$$

and $z_i := (-1)^{i-1} \frac{(2i)!}{2(i)!} e^{\otimes 2i} \in \mathcal{M}(A)^{\otimes 2i} .$

Then the element

$$c(e) := (y_n, z_n, y_{n-1}, z_{n-1}, \dots, y_1) \in \mathcal{M}(A)^{\otimes 2n+1} \oplus \mathcal{M}(A)^{\otimes 2n} \oplus \dots \oplus \mathcal{M}(A)$$

is a $2n$ -cycle in the complex $\text{Tot } CC(\mathcal{M}(A))$.

The image of $c(e)$ in $\text{Tot } BC(\mathcal{M}(A))$ is $(y_n, y_{n-1}, \dots, y_1)$.

Remark that $(2n)!/2(n!)$ is integral so k need not contain \mathbb{Q} .

Proof. The equalities $t(e^{\otimes 2i}) = -e^{\otimes 2i}$ and $t(e^{\otimes 2i+1}) = e^{\otimes 2i+1}$ imply that

$$b(-2e^{\otimes 2i+1}) = -2e^{\otimes 2i} = -(1-t)e^{\otimes 2i}$$

and

$$b'(-ie^{\otimes 2i}) = -ie^{\otimes 2i-1} = Ne^{\otimes 2i-1} .$$

Therefore $b(y_i) = -(1-t)(z_i)$ and $b'(z_i) = N(y_{i-1})$, so the chain $c(e)$ is a cycle in $\text{Tot } CC_{2n}(\mathcal{M}(A))$. □

8.3.4 Theorem. *For any unital k -algebra A the map*

$$\text{ch}_{0,n} : K_0(A) \rightarrow HC_{2n}(A) , \quad \text{ch}_{0,n}([e]) = \text{tr}(c(e))$$

is well-defined and functorial in A . It satisfies the formula

$$S \circ \text{ch}_{0,n}([e]) = \text{ch}_{0,n-1}([e]) .$$

Proof. By Lemma 8.3.3 and Theorem 2.2.9 the element $\text{tr}(c(e))$ is a cycle in $\text{Tot } CC(A)$. Its homology class depends only on the isomorphism class of e by the same argument as in the proof of 8.2.4. By properties of the trace map one has $c(e \oplus e') = c(e) + c(e')$ and so ch_n is well-defined.

Since the periodicity operator S consists in forgetting the first two components (cf. 2.2.1) it is clear from the explicit form of $c(e)$ that $S \circ \text{ch}_{0,n}([e]) = \text{ch}_{0,n-1}([e])$. \square

8.3.5 Corollary. *The Chern maps ch^λ and ch with values in H^λ and in HC are related by the formula*

$$p_* \circ \text{ch}_{0,n} = (-1)^n \frac{(2n)!}{n!} \text{ch}_{0,n}^\lambda. \quad \square$$

8.3.6 Examples. For $n = 0$ the map

$$\text{ch}_{0,0} : K_0(A) \rightarrow HC_0(A) = A/[A, A]$$

is simply induced by the trace of the idempotent. In particular if A is a field or a local ring or \mathbb{Z} , then $\text{ch}_{0,0}$ is an isomorphism.

Let $A = \mathbb{C}[x, y, z]/x^2 + y^2 + z^2 = 1$ be the algebraic 2-sphere. Then it is known that $K_0(A) = \mathbb{Z} \oplus K_0(\mathbb{C}) = \mathbb{Z} \oplus \mathbb{Z}$ and a generator of the non-trivial part (first copy of \mathbb{Z}) is the class of the idempotent $e = (1 + p)/2$ where

$$p = \begin{pmatrix} x & y + iz \\ y - iz & -x \end{pmatrix}.$$

The image of $[e]$ by $\text{ch}_{0,2}$ is the element

$$\text{tr} \left(\frac{1}{8} p dp dp \right) = -\frac{i}{2} (x dy dz + y dz dx + z dx dy) \in \Omega_{A|\mathbb{C}}^2 / d\Omega_{A|\mathbb{C}}^1 \subset HC_2(A)$$

which is infinite cyclic (volume form).

More generally ch detects the fundamental generator of K_0 of the algebraic sphere of dimension $2n$.

8.3.7 Interpretation in Terms of the Universal Example. Consider the (universal) ring $R = k[e]/(e^2 - e)$. An immediate computation shows that $HH_n(R) = 0$ for $n > 0$ and so $HC_{2n}(R) \cong HC_{2n-2}(R) \cong \dots \cong HC_0(R) = k \oplus ek$. An explicit representative of the generator $\{e\}$ of $HC_{2n}(R)$ corresponding to e in $HC_0(R)$ is given by the cycle $(y_n, y_{n-1}, \dots, y_1) \in (\text{Tot } \overline{BC}(R))_{2n}$ (cf. Lemma 8.3.3).

Any idempotent $e' \in \mathcal{M}_r(A)$ determines an algebra map $e' : R \rightarrow \mathcal{M}_r(A)$, $e \mapsto e'$ and obviously

$$\text{ch}_{0,n}([e']) = \text{Tr}(e'_* \{e\}) \in HC_{2n}(A).$$

One can easily extend the computation to negative and periodic cyclic homology of R . In particular in degree 0 one gets isomorphisms

$$HC_0^-(R) \cong HC_0^{\text{per}}(R) \cong HC_{2n}(R) \cong \dots \cong HC_0(R) = k \oplus ek,$$

and a representative of $\{e\} \in HC_0^-(R)$ corresponding to e in $HC_0(R)$ is given by the cycle $(y_1, y_2, \dots, y_n, \dots) \in (\text{Tot } \overline{BC}^-(R))_0$. This permits us to state the following

8.3.8 Proposition. *There is a well-defined functorial Chern character map*

$$\text{ch}_0^- : K_0(A) \rightarrow HC_0^-(A) (= HC_0^{\text{per}}(A)),$$

given by $\text{ch}_0^-([e]) = c(e)$, such that the following composite is ch_0 :

$$\begin{aligned} K_0(A) \rightarrow HC_0^-(A) = HC_0^{\text{per}}(A) &\rightarrow \lim_{\leftarrow} HC_{2n}(A) \rightarrow \dots \\ \dots \rightarrow HC_{2n}(A) \rightarrow HC_{2n-2}(A) &\rightarrow \dots \rightarrow HC_0(A). \end{aligned}$$

This map is compatible with the ring structures on K_0 and HC_0^- .

Proof. The argument is the same as in the proof of Proposition 8.2.6. Commutativity of the diagram follows from the explicit form of $c(e)$ and the fact that the various horizontal maps are induced by truncation (cf. Sect. 5.1).

In order to prove the compatibility with the product it is sufficient to prove it in the universal case. So let $R = k[e]/(e^2 - e)$ and $R' = k[e']/(e'^2 - e')$. In $K_0(R \otimes R')$ the product of $[e]$ and $[e']$ is simply the class of $e \otimes e'$. We know that $\text{ch}_0^-([e \otimes e'])$ is $\{e \otimes e'\} \in HC_0^-(R \otimes R')$ which corresponds to $e \otimes e' \in HC_0(R \otimes R')$.

On the other hand $\text{ch}_0^-([e]) \times \text{ch}_0^-([e']) = \{e\} \times \{e'\}$ is the class of a certain cycle in $(\text{Tot } \overline{BC}^-(R))_0$ whose first component is $e \otimes e'$ by definition of the product on HC_0^- (cf. 5.1.13). Since the projection onto the first component gives an isomorphism $HC_0^-(R \otimes R') \cong HC_0(R \otimes R')$ (just as for R) it is clear that $\text{ch}_0^-([e]) \times \text{ch}_0^-([e'])$ corresponds to $e \otimes e' \in HC_0(R \otimes R')$ and we have proved the equality

$$\text{ch}_0^-([e] \times \text{ch}_0^-([e']) = \text{ch}_0^-([e]) \times [e']). \quad \square$$

The comparison with the classical Chern character with value in the de Rham cohomology is given by the following

8.3.9 Proposition. *For any k -algebra A (with $k \supset \mathbb{Q}$) the composite*

$$K_0(A) \rightarrow HC_0^{\text{per}}(A) \rightarrow H_{\text{DR}}^{\text{ev}}(A)$$

is, up to a constant, the classical Chern character ch .

Proof. For the idempotent e the image of $[e]$ by the composite map is

$$(-1)^{n-1} \frac{(2n)!}{2(n)!} \text{tr}(edede \dots de) \in \Omega_{A|k}^{2n}.$$

Up to a constant this is the Chern character of the Levi-Civita connection (cf. formula 8.1.8.1). □

8.3.10 Cohomological Interpretation: Chern-Connes Pairing. In the cohomological framework the Chern map is replaced by a pairing

$$\langle -, - \rangle : K_0(A) \times H_\lambda^{2n}(A) \rightarrow k$$

which is constructed as follows. Let $f \in C_{2n}^\lambda(\mathcal{M}(A))$ be a cyclic cocycle, that is a linear functional $f : \mathcal{M}(A)^{\otimes 2n+1} \rightarrow k$, which satisfies the equation $b \circ f = 0$ and which is cyclic (cf. 2.4.2). Then there is a pairing (Chern-Connes pairing) $K_0(A) \times H_\lambda^{2n}(\mathcal{M}(A)) \rightarrow k$ given by

$$\langle [e], (f) \rangle = f(e, \dots, e) .$$

The last step is to use Morita invariance for H_λ^{2n} .

This pairing can be lifted (up to multiplication by a constant) to a pairing

$$\langle -, - \rangle : K_0(A) \times HC^{2n}(A) \rightarrow k ,$$

which is compatible with the periodicity map S . The relationship with the Chern character described above takes the following form. The composite

$$K_0(A) \times HC^{2n}(A) \xrightarrow{ch \times id} HC_{2n}(A) \times HC^{2n}(A) \rightarrow k ,$$

where the last pairing was described in 2.4.8, is the Chern-Connes pairing.

For a topological algebra A the group $K_0(A)$ is simply obtained by ignoring the topology of A . So the pairing is easily extended to the topological version of cyclic cohomology.

In Connes [1988] this pairing is extended to entire cyclic cohomology (cf. Sect. 5.6). This result plays a fundamental role in the applications to the Novikov conjecture (cf. Sect. 12.3).

8.3.11 Chern Character in the Non-commutative Torus Case. Let us adopt the terminology and notation of 5.6.5 about the non-commutative torus algebra \mathcal{A}_θ . A computation due to Pimsner and Voiculescu [1982] shows that $K_0(\mathcal{A}_\theta)$ is a free abelian group of rank 2 with generators

- \mathcal{A}_θ (considered as a right f.g.p. module over itself),
- $\mathcal{S}(\mathbb{R}) =$ the ordinary Schwartz space of the real line, with the right-module structure over \mathcal{A}_θ given by

$$(\xi \cdot x)(s) = \xi(s + \theta), (\xi \cdot y)(s) = \exp(2\pi is)\xi(s) \text{ for } s \in \mathbb{R} \text{ and } x \in \mathcal{S}(\mathbb{R}) .$$

Denote their class in $K_0(\mathcal{A}_\theta)$ by $[1]$ and $[S]$ respectively. The Chern-Connes pairing (in the topological framework) with the generators $S\tau$ and ϕ of $HC_{\text{per}}^0(\mathcal{A}_\theta) = HC^2(\mathcal{A}_\theta)$, alluded to in 5.6.5, is given by the following table (cf. Connes [C, Lemma 54]):

$$\begin{aligned} \langle S\tau, [1] \rangle &= 1, & \langle S\tau, [S] \rangle &= \theta, \\ \langle \phi, [1] \rangle &= 0, & \langle \phi, [S] \rangle &= 1. \end{aligned}$$

Note that the parameter θ does not show up in the computation of HC . In particular the result is, up to isomorphism, the same in the commutative case and in the non-commutative case. However the Chern isomorphism heavily depends on θ .

Exercises

E.8.3.1. Show that K_0 is Morita invariant and that ch_0 is compatible with Morita invariance.

E.8.3.2. Show that $HC_{2n}(k[e]/(e^2 - e))$ is concentrated in the λ -degree n , that is $HC_{2n} = HC_{2n}^{(n)}$.

E.8.3.3. Show that $[e^{\otimes 2n+1}]$ generates $H_{2n}^\lambda(k[e]/(e^2 - e))/H_{2n}^\lambda(k)$ and that, in characteristic zero,

$$S[e^{\otimes 2n+1}] = -\frac{1}{2(2n - 1)} [e^{\otimes 2n-1}].$$

(Use either 2.2.7 or the discussion of this section.)

E.8.3.4. Show that the Chern-Weil theory can be extended to the non-commutative differential forms framework as described in Sect.2.6. In particular show that the composite

$$K_0(A) \xrightarrow{\text{ch}_0^-} HC_0^-(A) \rightarrow H_{\text{DR}}^{\text{ev}}(A)$$

sends $[e]$ to the class of $edede \dots de$ (cf. Karoubi [1983] and [1987]).

8.4 The Dennis Trace Map and the Generalized Chern Character

This section deals with the construction of the generalized Chern character

$$\text{ch}_n^- : H_n(GL(A)) \rightarrow HC_n^-(A), \quad n \geq 1.$$

Because of the different nature of the source ($H_n(GL(A))$ versus K_0) the construction here differs from the case $n = 0$. The main idea is to use the construction of a sequence of simplicial modules due to Keith Dennis [1976] (cf. 8.4.2.1) and to remark that this is in fact a sequence of cyclic modules.

By composing with the maps from negative cyclic homology to the various cyclic homology groups one gets natural maps

$$\text{ch}_{n,i} : H_n(GL(A)) \rightarrow HC_{n+2i}(A), \quad n \geq 1 \quad \text{and} \quad i \geq 0.$$

This case was first treated by Connes for $n = 1$ and then by Karoubi for all n . Its natural lifting to HC^- is due to J.D.S. Jones [1987].

8.4.1 The Fusion Map. Let $G = GL_r(A)$ be the general linear group of $r \times r$ -matrices with coefficients in the k -algebra A . Its elements are the invertible matrices in $\mathcal{M}_r(A)$ and so there is a canonical inclusion $GL_r(A) \hookrightarrow \mathcal{M}_r(A)$. The *fusion map* is the unique k -algebra homomorphism

$$f : k[GL_r(A)] \rightarrow \mathcal{M}_r(A)$$

which extends this inclusion. It simply consists in replacing a formal sum of invertible matrices by an actual sum. Remark that this map is not readily compatible with stabilization, since the stabilization process is not the same for GL and for \mathcal{M} (cf. 8.4.3 below).

8.4.2 A Sequence of Cyclic Modules. Consider for all n the following sequence of k -modules where $G = GL_r(A)$:

(8.4.2.1)

$$k[G^n] \xrightarrow{\text{inc}} k[G^{n+1}] \cong k[G]^{\otimes n+1} \xrightarrow{f^{\otimes n+1}} \mathcal{M}_r(A)^{\otimes n+1} \xrightarrow{\text{tr}} A^{\otimes n+1}.$$

The left-hand side map is given by $\iota(g_1, \dots, g_n) = ((g_1 g_2 \dots g_n)^{-1}, g_1, \dots, g_n)$. The map f is the fusion map as described above and tr is the generalized trace map introduced in 1.2.1.

All these modules for $n \geq 0$ assemble to give rise to cyclic modules. Indeed the left-hand side cyclic module $([n] \mapsto k[G^n])$ is $k[B, G]$ (cf. 7.3.3). Its (injective) image via ι is the subcyclic module $k[B, (G_1, 1)]$ of $k[\Gamma, G]$ (cf. 7.4.5). The other cyclic modules are respectively $C(k[G])$, $C(\mathcal{M}_r(A))$ and $C(A)$. It is clear that all the maps in the sequence (8.4.2.1) are simplicial. But in fact it is immediate to check that all these maps are *cyclic maps*:

- for ι it is proved in 7.4.5,
- for $f^{\otimes n+1}$ it comes from the fact that f is an algebra map,
- for tr it was proved in 2.2.8.

So one can apply any of the following functors: $HH_n, HC_n, HC_n^-, HC_n^{\text{per}}$ and, under some hypothesis on A , the functors HD_n, HQ_n , etc.

8.4.3 Proposition (Dennis Trace Map). *The sequence of simplicial modules (8.4.2.1) defines for any integer r (including $r = \infty$) a natural map, called “Dennis trace map”:*

$$\text{Dtr} : H_n(GL_r(A), k) \rightarrow HH_n(A),$$

which is compatible with the stabilization map on the general linear group.

Proof. The Dennis trace map is obtained by applying the functor H_n to the sequence of simplicial modules (8.4.2.1).

Though the fusion map does not commute with stabilization, the composite

$$k[GL_r(A)]^{\otimes n+1} \rightarrow \mathcal{M}_r(A)^{\otimes n+1} \rightarrow A^{\otimes n+1} \rightarrow \overline{C}_n(A) = A \otimes \overline{A}^{\otimes n}$$

does since

$$\text{tr} \left(\left[\begin{array}{c|c} \alpha & \\ \hline & 1 \end{array} \right] \otimes \dots \otimes \left[\begin{array}{c|c} \gamma & \\ \hline & 1 \end{array} \right] \right) = \text{tr}(\alpha \otimes \dots \otimes \gamma) + 1 \otimes \dots \otimes 1$$

and $1 \otimes \dots \otimes 1 = 0$ in $\overline{C}_n(A)$. Therefore, under stabilization, we do get a well-defined map

$$\text{ch}_n : H_n(GL(A), k) \rightarrow HH_n(A), \quad n \geq 1. \quad \square$$

8.4.4 The Chern Character Map. From the sequence of cyclic modules (8.4.2.1) one deduces a sequence of bicomplexes by applying the functor CC^- (cf. Sect. 5.1)

(8.4.4.1)

$$CC^-(G) := CC^-(k[B.G]) \hookrightarrow CC^-(k[G]) \rightarrow CC^-(\mathcal{M}_r(A)) \rightarrow CC^-(A).$$

Taking homology of these bicomplexes gives a map $HC_n^-(G) \rightarrow HC_n^-(A)$. In 7.3.9 we computed the first group in terms of the homology of G :

$$HC_n^-(G) = \prod_{i \geq 0} H_{n+2i}(G, k).$$

In particular there is a canonical inclusion of $H_n(G, k)$ in it. The composite gives the *Chern character map*

(8.4.4.2)

$$\text{ch}_n^- : H_n(GL_r(A), k) \rightarrow HC_n^-(GL_r(A)) \rightarrow HC_n^-(A) \quad \text{for } n \geq 1.$$

8.4.5 Theorem. *The Chern character map*

$$\text{ch}_n^- : H_n(GL_r(A), k) \rightarrow HC_n^-(A),$$

defined for $n \geq 1$ and any integer r (including $r = \infty$), is natural in A , compatible with the stabilization of GL_r and lifts the Dennis trace map

$$\begin{array}{ccc} & & HC_n^-(A) \\ & \nearrow \text{ch}^- & \downarrow h \\ H_n(GL(A)) & \xrightarrow{\text{Dtr}} & HH_n(A). \end{array}$$

Proof. Naturality is obvious by construction. Stabilization property is proved as in Proposition 8.4.3. Compatibility with the Dennis trace map consists in applying the functor $h : CC^- \rightarrow C$ (cf. 5.1.4.1) to the sequence (8.4.2.1) and to remark that $h : CC^-(k[B.G]) \rightarrow C(k[B.G]) = C(G; k)$ is precisely the projection map used in the definition of the Chern character. \square

8.4.6 Chern Character with Values in HC_* . Recall from 5.1.8 that HC_n^- maps naturally to HC_n^{per} and then to HC_{n+2i} for any $i \geq 0$. Therefore under composition with the above Chern character one gets new maps, still called Chern character,

$$\begin{aligned} \text{ch}_n^{\text{per}} : H_n(GL(A), k) &\rightarrow HC_n^{\text{per}}(A), \\ \text{ch}_{n,i} : H_n(GL(A), k) &\rightarrow HC_{n+2i}(A). \end{aligned}$$

By definition they all fit into a commutative diagram

$$\begin{array}{ccccccc} & & & H_n(GL(A), k) & & & \\ & \swarrow & & \searrow & \searrow & & \searrow \\ \text{ch}_n^- & & \text{ch}_n^{\text{per}} & & \text{ch}_{n,i} & & \\ HC_n^-(A) & \rightarrow & HC_n^{\text{per}}(A) & \rightarrow \dots \rightarrow & HC_{n+2i}(A) & \rightarrow \dots \rightarrow & HC_n(A). \end{array}$$

8.4.7 The Particular Case $K_1(A) \rightarrow HC_1^-(A)$. For $n = 1$ and $k = \mathbb{Z}$, $H_1(GL(A), \mathbb{Z}) = GL(A)_{ab}$ is also denoted $K_1(A)$ (here we slightly anticipate on Chap. 11, at least as far as notation is concerned). Therefore the Chern character gives a map

$$\text{ch}_1^- : K_1(A) \rightarrow HC_1^-(A).$$

In order to give an explicit description of this map (in the spirit of the $n = 0$ case) we need to focus on the particular element $\{x\} \in HC_1^-(\mathbb{Z}[x, x^{-1}])$ that we now define. Let F be the free group on one generator x (it is isomorphic to the infinite cyclic group \mathbb{Z} but adopting this notation would be too confusing here). Since $\mathbb{Z}[x, x^{-1}] \cong \mathbb{Z}[F]$, we know (cf. 7.4.6 and 7.4.7) that $HC_1^-(\mathbb{Z}[x, x^{-1}])$ splits into a direct product of abelian groups, all isomorphic to $HC_1^-(F)$, the index set being F itself. The element $\{x\}$ corresponds, under this splitting, to the canonical generator of $H_1(F) \subset H_1(F) \times H_3(F) \times \dots = HC_1^-(F)$, where this latter group is identified with the component of index 1 (trivial element in F) in the decomposition of $HC_1^-(\mathbb{Z}[x, x^{-1}])$.

The following lemma gives a cycle description of $\{x\}$.

8.4.8 Lemma. *Let $z_n := (n - 1)!(x^{-1}, x, x^{-1}, \dots, x^{-1}, x) \in (\mathbb{Z}[x, x^{-1}])^{\otimes 2n}$. Then the element $z := (z_1, \dots, z_n, \dots) \in \text{ToT}(\overline{BC}^-(\mathbb{Z}[x, x^{-1}]))_1$ is a cycle whose homology class is $\{x\} \in HC_1^-(\mathbb{Z}[x, x^{-1}])$.*

Proof. Recall that ToT means the *product* and not the sum (cf. 5.1.2), so $\text{ToT}(\overline{BC}^-(A))_1 = A^{\otimes 2} \times A^{\otimes 4} \times \dots$. To prove that z is a cycle it suffices

to show that $b(z_n) = B(z_{n-1})$. Since we are working with \overline{BC} (that is in the normalized framework) we have

$$b(x^{-1}, x, \dots, x) = (1, x^{-1}, \dots, x) - (1, x, \dots, x^{-1}).$$

On the other hand

$$B(x^{-1}, x, \dots, x) = n((1, x^{-1}, x, \dots, x) - (1, x, x^{-1}, \dots, x^{-1})),$$

whence the equality $b(z_n) = B(z_{n-1})$.

The element z is in $\overline{BC}^-(\mathbb{Z}[B, F])$, that is in the component indexed by 1, because $x^{-1}x \dots x^{-1}x = 1$. We know a priori that $HC_1^-(\mathbb{Z}[B, F]) \rightarrow H_1(F)$ is an isomorphism because $H_i(F) = 0$ for $i > 1$. Therefore it suffices to check that the image of z_1 in $C(F, k)$ generates $H_1(F)$. This is clear because $z_1 = 0!(x^{-1}, x) = (x^{-1}, x)$ comes from the element $x \in \mathbb{Z}[F] \subset BC^-(\mathbb{Z}[F])_1$ and the class of x is precisely the generator of $H_1(F)$. \square

Giving an invertible matrix $\alpha \in GL_r(A)$ is equivalent to giving a ring homomorphism $\alpha : \mathbb{Z}[x, x^{-1}] \rightarrow \mathcal{M}_r(A)$, $x \mapsto \alpha$. By naturality one gets an element $\alpha_*\{x\} \in HC_1^-(\mathcal{M}_r(A))$.

8.4.9 Proposition. *For any $\alpha \in GL_r(A)$ representing $[\alpha] \in K_1(A)$ one has*

$$\begin{aligned} \text{ch}_1^-([\alpha]) &= \text{tr}(\alpha_*\{x\}) \\ &= \text{class of } (\dots, n!(\alpha^{-1}, \alpha, \dots, \alpha^{-1}, \alpha), \dots) \in HC_1^-(A). \end{aligned}$$

If A is commutative its image by the natural map $HC_1^-(A) \rightarrow HC_1(A) = \Omega_{A|k}^1/dA$ is $(\det \alpha)^{-1}d(\det \alpha)$.

Proof. By naturality of ch^- it suffices to show that $\text{ch}_1^-(x) = \{x\}$. The natural inclusion $F \hookrightarrow G = GL(\mathbb{Z}[x, x^{-1}])$ which sends x to the matrix

$$\begin{pmatrix} x & & & \\ & 1 & & \\ & & 1 & \\ & & & \dots \end{pmatrix}$$

determines a commutative diagram

$$\begin{array}{ccccc} C(F) & \longleftarrow & CC^-(F) & \longrightarrow & CC^-(\mathbb{Z}[F]) \\ \downarrow & & \downarrow & & \downarrow \\ C(G) & \longleftarrow & CC^-(G) & \longrightarrow & CC^-(\mathbb{Z}[G]) \end{array}$$

Under these various maps the element $\{x\} \in HC_1^-(\mathbb{Z}[x, x^{-1}])$ corresponds to the canonical generator of $H_1(F)$ and so to $[x] \in H_1(GL(\mathbb{Z}[x, x^{-1}]))$. Since the composition

$$CC^-(\mathbb{Z}[F]) \rightarrow CC^-(\mathbb{Z}[G]) \rightarrow CC^-(\mathcal{M}(\mathbb{Z}[x, x^{-1}])) \xrightarrow{\text{tr}} CC^-(\mathbb{Z}[x, x^{-1}])$$

is the identity (it is already the identity at the algebra level) the formula $\text{ch}_1^-(x) = \{x\}$ is proved.

The second equality follows from Lemma 8.4.8.

In order to check the last formula we first check that the image of $\{x\}$ in HC_1 is the class of (x^{-1}, x) , that is the class of $x^{-1}dx \in \Omega^1/d\Omega^0$. Then one applies the result of Exercise E.1.2.3. \square

The following result compares the Chern character from K_0 and from K_1 .

8.4.10 Proposition. *For any ring A there is a natural commutative diagram where the vertical maps (which are injective) are product with $[x] \in K_1(\mathbb{Z}[x, x^{-1}])$ and with $\{x\} \in HC_1^-(\mathbb{Z}[x, x^{-1}])$ respectively*

$$\begin{array}{ccc} K_0(A) & \xrightarrow{\text{ch}_0^-} & HC_0^-(A) \\ \downarrow & & \downarrow \\ K_1(A[x, x^{-1}]) & \xrightarrow{\text{ch}_1^-} & HC_1^-(A[x, x^{-1}]) . \end{array}$$

Proof. On algebraic K -theory the product by $[x]$ is given by $[e] \mapsto [xe + 1 - e]$ where e is an idempotent. Remark that $xe + 1 - e$ is invertible with inverse $x^{-1}e + 1 - e$. On negative cyclic homology the product is induced by the shuffle products (shuffles and cyclic shuffles) and was described in 5.1.13.

To prove the commutativity of the diagram it suffices again to deal with the universal case, that is with $R = k[e]/(e^2 - e)$. Then the proof follows from the explicit computation of $HC_1^-(k[e, f, x, x^{-1}]/(e^2 - e, f^2 - f))$ as in the proof of Proposition 8.3.8. The details are left to the reader. \square

8.4.11 Remark. The injective map $K_0(A) \rightarrow K_1(A[x, x^{-1}])$ is in fact naturally split (cf. Bass [1968]) and so is the HC^- -map. Therefore, strictly speaking, the Chern character theory for K_0 is contained in the Chern character theory for K_1 .

8.4.12 Chern Character and Product. The preceding result is in fact a particular case of a more general one which asserts that the Chern map from algebraic K -theory to negative cyclic homology is compatible with the ring structures (cf. 11.2.10). In dimension strictly greater than 0 this is a consequence of the following assertion: the Chern map

$$\text{ch}^- : H_*(GL(A)) \rightarrow HC_*^-(A)$$

is compatible with the product induced by the tensor product of matrices on the left-hand side (cf. Gaucher [1992]) and by the shuffle product on the right

one. At the time of writing there does not seem to be any proof in print (see Exercise E.8.4.4).

A consequence of this property is a formula for the composite

$$K_2^M(A) \rightarrow K_2(A) \xrightarrow{\text{ch}^-} HC_2^-(A) \rightarrow H_{\text{DR}}^2(A)$$

where K_2^M is Milnor K -theory (cf. 11.1.15). Let x and y be invertible elements in A . They determine an element $\{x, y\}$ (Steinberg symbol) in $K_2^M(A)$. On the other hand $x^{-1}y^{-1} dx dy$ defines an element in $H_{\text{DR}}^2(A)$. The above composition sends $\{x, y\}$ to $x^{-1}y^{-1} dx dy$. One can easily give an ad hoc proof of this statement.

8.4.13 Chern-Connes Pairing (Cohomological Framework). Dualizing the Chern character defined above gives a pairing

$$\langle -, - \rangle : K_n(A) \times HC^{n+2i}(A) \rightarrow k$$

which is in fact the composite

$$K_n(A) \times HC^{2n+i}(A) \xrightarrow{\text{ch} \times \text{id}} HC_{n+2i}(A) \times HC^{n+2i}(A) \rightarrow k .$$

The compatibility of this pairing with the S -map follows from the preceding results. Here we anticipate on the next chapters by putting $K_n(A)$ instead of $H_n(GL(A), k)$, see Sect. 11.2 for more comments.

8.4.14 Additive Version of the Chern Character. In this subsection we freely use the notions, notation and results of the first 2 sections of Chap. 10.

If one replaces the general linear group by the Lie algebra of matrices, then there is still defined a fusion map

$$f : U(gl(A)) \rightarrow \mathcal{M}(A) .$$

It is induced by $g_1 \otimes g_2 \otimes \dots \otimes g_n \mapsto g_1 g_2 \dots g_n$ (product in $\mathcal{M}(A)$). The relations of the universal enveloping algebra are verified since

$$f(\alpha \otimes \beta - \beta \otimes \alpha) = \alpha\beta - \beta\alpha = [\alpha, \beta] = f([\alpha, \beta]) .$$

So we can play the same game as before (see Sect. 3.3) for the computation of cyclic homology of $U(gl(A))$ and we get an additive Chern character

$$\text{ch}^{\text{add}} : H_*(gl(A), k) \rightarrow HC_*^-(U(gl(A))) \rightarrow HC_*^-(A) .$$

Suppose now that $k \supset \mathbb{Q}$. Then in Sect. 10.2 we construct a map $HC_{*-1}(A) \rightarrow H_*(gl(A), k)$ which turns out to be injective (cf. Theorem 10.2.4).

8.4.15 Proposition. *The composite*

$$HC_{*-1}(A) \hookrightarrow H_*(gl(A), k) \xrightarrow{\text{ch}^{\text{add}}} HC_*^-(A)$$

is the boundary map B appearing in the long exact sequence relating HC , HC^{per} and HC^- (cf. Proposition 5.1.5).

Proof. This is a straightforward computation whose ingredients are

- Sect. 10.2 for the map $HC_{*-1} \rightarrow H_*(gl)$,
- Sect. 3.3 for the map $H_*(gl) \rightarrow HC_*(U(gl))$,
- 8.4.14 for the additive fusion map,
- 2.2.9 for the trace map. □

Remark. This map is compatible with the product and this takes the form $B(x \times By) = Bx \times By$, which is Corollary 4.3.5.

8.4.16 Corollary. *The Dennis trace map in the additive framework gives a homomorphism $H_*(gl(A), k) \rightarrow HH_*(A)$, and the composite $HC_{*-1}(A) \hookrightarrow H_*(gl(A), k) \rightarrow HH_*(A)$ is Connes boundary map B .* □

Exercises

E.8.4.1. Fix a positive integer r . The Chern character ch_n^- was defined by selecting the component $H_n(G)$ into the product $H_n(G) \times H_{n+2}(G) \times \dots$. So a priori one can define a new Chern character $ch_n^{-,r}$ by choosing the component $H_{n+2r}(G)$. Show that $ch_n^{-,r} = S^r \circ ch_{n+2r}$.

E.8.4.2. Show, on an example, that ch_n^- can detect elements which vanish via ch_n^{per} and a fortiori via $ch_{n,i}$. (Example $A = k[\varepsilon]/\varepsilon^2 = 0$ and take $\langle\langle \varepsilon, \varepsilon, \varepsilon \rangle\rangle \in K_3(A) \subset H_3(GL(A))$, (cf. Loday [1981] or Exercise E.11.2.5).)

E.8.4.3. Show that ch^- is trivial on the decomposable part of $H_*(GL(A))$. In other words let $x.y$ be the product of x and $y \in \tilde{H}_*(GL(A))$ induced by the direct sum \oplus , (cf. 12.2.12). Then show that $ch^-(x.y) = 0$.

E.8.4.4. Suppose that A is commutative. Show that the tensor product of matrices gives rise to a well-defined map

$$\tilde{\otimes} : H_p(GL(A)) \times H_q(GL(A)) \rightarrow H_{p+q}(GL(A))$$

which makes the following diagram commutative ($\mathcal{H} = H_*(GL(A), k)$, $T =$ twisting map):

$$\begin{array}{ccc} \mathcal{H}^3 & \xrightarrow{id \times \cdot} & \mathcal{H}^2 \\ \downarrow \Delta \times id & & \downarrow \tilde{\otimes} \\ \mathcal{H}^4 & & \\ \downarrow id \times T \times id & & \\ \mathcal{H}^4 & \xrightarrow{\tilde{\otimes} \times \tilde{\otimes}} & \mathcal{H}^2 \quad \longrightarrow \quad \mathcal{H} \end{array}$$

(cf. Gaucher [1991a].)

8.5 The Bass Trace Conjecture and the Idempotent Conjecture

The Chern character with value in cyclic homology or more precisely the Chern-Connes pairing was developed by A. Connes to prove an index formula in the non-commutative framework. It turns out that this index formula is an efficient tool to attack the so-called *idempotent conjecture*. This conjecture claims that for a torsion-free group G the only idempotents in the group algebra $\mathbb{C}[G]$, or more generally in the reduced C^* -algebra $C_r^*(G)$, are 0 and 1. It has been proved for some groups G by using the Chern-Connes pairing.

Closely related to the idempotent conjecture is the Bass trace conjecture which concerns the Grothendieck group of the group algebra $\mathbb{Z}[G]$. The connection with cyclic homology begins with the following remark: the Hattori-Stallings trace map is nothing but the Chern map $\text{ch}_{0,0}$. We begin this section by the Bass trace conjecture along the lines of B. Eckmann [1986].

The second part of this section, devoted to the idempotent conjecture, is essentially due to A. Connes. We only give a sketchy account of it here.

8.5.1 Hattori-Stallings Trace Map. Let A be a ring and let P be a (right) f.g.p. A -module. Let $A_{ab} = A/[A, A]$ be the abelianization of A that is the quotient by the additive commutators $ab - ba$ (note that $A_{ab} = HH_0(A) = HC_0(A)$). The *Hattori-Stallings trace map* is a homomorphism $T : \text{End}_A(P) \rightarrow A_{ab}$ defined as follows. Since P is f.g.p. there is an isomorphism $\text{End}_A(P) \cong P \otimes_A P^*$ and T is the composition with the map $(x \otimes f) \mapsto f(x)$, $x \in P$, $f \in P^* = \text{Hom}_A(P, A)$. Suppose now that A is the group algebra $k[G]$ of the group G over the commutative ring k . Then A_{ab} is a free module over k with basis the conjugation classes of G . For fixed P and fixed conjugation class $\langle z \rangle$ the coefficient of $\langle z \rangle$ in $T(\text{id}_P)$ is denoted $r_P \langle z \rangle$ and called the $\langle z \rangle$ -rank of P (over k).

8.5.2 Bass Trace Conjecture. *Let G be a group and let P be a f.g.p. $\mathbb{Z}[G]$ -module. Then $r_P \langle z \rangle = 0$ for $z \neq 1$ in G .*

The following easy statement permits us to frame this problem in our setting.

8.5.3 Proposition. *For any f.g.p. A -module P one has $\text{ch}_0([P]) = T(\text{id}_P)$ and so, when $A = k[G]$, one has*

$$\text{ch}_0([P]) = \sum_{\langle z \rangle \in \langle G \rangle} (r_P \langle z \rangle) \langle z \rangle \in (k[G])_{ab} = HC_0(k[G]).$$

Proof. Let $P = \text{Im } e$ for some idempotent e in $\mathcal{M}(A)$. From the definition of the Hattori-Stallings map we have $T(\text{id}_P) = \text{Tr}(e) \in A_{ab}$. On the other hand the Chern character ch_0 is also given by $\text{ch}_0([e]) = \text{Tr}(e) \in HC_0(A) = A_{ab}$. \square

The following result gives homological conditions which ensure the validity of the Bass conjecture for torsion free groups.

8.5.4 Theorem. *Let G be a torsion free group. If the group $G_z/\{z\}$ has finite homological dimension for all $z \in G$ (where G_z is the centralizer of z), then the Bass trace conjecture is true for G .*

Proof. By Proposition 8.3.8 ch_0 factors through $HC_{2n}(\mathbb{Z}[G])$ for all $n \geq 0$. On the other hand since G is torsion free the subset $\langle G \rangle^{\text{fin}}$ of the set of conjugation classes $\langle G \rangle$ is reduced to the unique element $\langle 1 \rangle$ and in order to prove that $r_P\langle z \rangle = 0$ for $z \neq 1$ it suffices to show that $0 = HC_{2n}(\mathbb{Z}[G])_{\langle z \rangle} = HC_{2n}(\mathbb{Z}[B.(G_z, z)])$ for $z \neq 1$ (with the notation of Sect. 7.3). Since z is infinite cyclic, one has $HC_{2n}(\mathbb{Z}[B.(G_z, z)]) = H_{2n}(G_z/\{z\}, \mathbb{Z})$ (cf. 7.3.6). It follows from the homological assumption that this last group is 0 for n sufficiently large. This implies the vanishing of $r_P\langle z \rangle$ for $z \neq 1$. \square

8.5.5 Examples. Explicit examples require the computation of homological dimension of discrete groups and this is beyond the scope of this book. So we refer to the literature (Eckmann [1986]), where it is proved that the homological hypothesis of Theorem 8.5.4 is fulfilled for torsion free groups G , with finite homological dimension, which are either

- nilpotent,
- solvable,
- linear ($G \subset GL_r(F)$ with $F =$ characteristic zero field),
- or of cohomological dimension ≤ 2 .

The Bass trace conjecture is obviously related to the following classical problem.

8.5.6 Idempotent Conjecture. *Let k be a field (resp. \mathbb{C}) and G a torsion free group. Then the only idempotents of the group algebra $k[G]$ (resp. the reduced C^* -algebra $C_r^*(G)$) are 0 and 1.*

This is called the *idempotent conjecture* (resp. the *generalized R. V. Kadison conjecture*).

8.5.7 The Reduced C^* -Algebra and the Canonical Trace Map. Let us recall that to any discrete countable group G there is associated a C^* -algebra $C_r^*(G)$, called the reduced C^* -algebra of G (cf. 5.6.6). It contains the group algebra $\mathbb{C}[G]$.

The canonical trace $\tau : C_r^*(G) \rightarrow \mathbb{C}$ is the unique positive bounded (hence continuous) map which extends the trace on $\mathbb{C}[G]$ and is given by $\tau(\sum a_g g) = a_1$ (the $\langle 1 \rangle$ -rank). This trace can be extended to idempotents in matrices over $C_r^*(G)$ and so gives a map

$$\tau_* : K_0(C_r^*(G)) \rightarrow \mathbb{C} .$$

8.5.8 Conjecture (Integrality of the Trace). *If G is torsion free, then the image in \mathbb{C} of the canonical trace τ_* is \mathbb{Z} .*

Let us show briefly how this conjecture implies the idempotent conjecture for $C_r^*(G)$ (more details can be found in the excellent survey of A. Valette [1989]). Let e be an idempotent in $C_r^*(G)$. Up to conjugation by an invertible element one can suppose that e verifies $e = e^* = e^2$. Then $\tau(e) = \tau(ee^*)$ and $\tau(1 - e) = \tau((1 - e)(1 - e^*))$ are positive integers. Since $\tau(e) + \tau(1 - e) = 1$ one can suppose that $\tau(e) = 0$. Then $\tau(ee^*) = 0$ and by the faithfulness of the trace it implies $e = 0$.

8.5.9 Relevance of Cyclic Homology to the Idempotent Conjecture.

In many cases the canonical trace can be seen as the Chern-Connes pairing with a particular element α in $HC^{2n}(C_r^*(G))$:

$$\tau_*([e]) = \langle [e], \alpha \rangle \in \mathbb{C} .$$

If the element α is the character of a p -summable Fredholm module, then it turns out that the pairing takes its values in $K_0(\mathbb{C}) = \mathbb{Z}$. This shows the integrality of the trace. We refer to the literature for explicit examples, cf. Connes [1990b].

Exercise

E.8.5.1. Selberg Principle for Modular Representations. Let G be a group and let $z \in G$ be such that its class in $(G_z)_{ab}/(G_z)_{ab}^p$ is $\neq 0$. Show that for any idempotent $e = \sum_g e(g)g$ in $k[G]$ one has

$$\sum_{g \in G/G_z} e(gzg^{-1}) = 0 \quad \text{in } k .$$

(Mimick the proof of Theorem 8.5.4, cf. Blanc-Brylinski [1992].)

Bibliographical Comments on Chapter 8

The Chern character is certainly one of the most famous tools in algebraic topology and differential geometry. It has numerous different constructions and is treated in even more numerous textbooks. One of them is Milnor-Stasheff [1974]. Here we recalled the Chern-Weil definition in a, somehow, algebraic style, because it suits the sequel best.

The importance of the expression $\text{tr}(e de de \dots de)$ was recognized quite early by Alain Connes, and independently by Max Karoubi. In fact it was the main motivation of Connes for studying cyclic homology (cf. Connes [C]). The translation in the homological framework was routine. Then came the extension of the Chern map to $K_1 = H_1(GL)$ (loc. cit.) and later to K_n by Karoubi [1987]. The invariance of this Chern character map under composition with the S -map was proved by

these authors in their respective cases. The lifting to the HC^- -theory is due to J.D.S. Jones [1987], see also Goodwillie [1986]. This is one side of the story.

The other side goes back to an unpublished paper of Keith Dennis [1976], where he constructs the so-called *Dennis trace map*. In fact, as already mentioned, the new idea was really to use the *fusion map*. It is unfortunate that cyclic homology (and the notion of cyclic modules) was not around at that time because it is actually the lifting of the Dennis trace map to *cyclic* homology, which gives interesting invariants.

For an elegant and efficient way to construct cyclic cocycles by using the Chern-Weyl theory, see Quillen [1989].

For the bivariant Chern character see Kassel [1989a], Wang [1990, 1992]. For the Chern character in the C^* -algebra setting see Baum-Connes [1988] and subsequent papers by A. Connes.

Chapter 9. Classical Invariant Theory

In the comparison of the homology of the Lie algebra of matrices with cyclic homology one of the key points is the following result which pertains to invariant theory: there is an isomorphism

$$(gl(k)^{\otimes n})_{gl(k)} \cong k[S_n].$$

The aim of this small chapter is to give a self-contained account of the part of invariant theory which is needed to compute the homology groups $H_*(gl(A))$ in the next chapter together with some more material to begin the computation of $H_*(gl_r(A))$ for fixed r .

The first section states the fundamental theorems of invariant theory as they are classically stated.

In Sect. 9.2 they are translated into the coinvariant framework in which we are going to work in the next chapter. It gives the isomorphism stated above, but we also give information on $(gl_r(k)^{\otimes n})_{gl_r(k)}$ for any r . Though these results will only be used for $r \geq n - 1$ we state them in full generality.

Section 9.3 describes the relations with the classical Cayley-Hamilton formula and Amitsur-Levitzki formula.

Section 9.4 contains proofs of the fundamental theorems.

Section 9.5 is devoted to similar results with the general linear group replaced by the orthogonal or symplectic group.

Notation. In this chapter k is a field, unless otherwise stated. We freely abbreviate vector space into space. Let G be a group and V be a left $k[G]$ -module. By definition the space of *invariants* is

$$V^G := \{v \in V \mid g.v = v \text{ for all } g \in G\}$$

and the space of *coinvariants* is

$$V_G := k \otimes_{k[G]} V = V / \{g.v - v \mid v \in V, g \in G\}.$$

When G is finite and $|G|$ invertible in k , there is a canonical isomorphism $V_G \cong V^G$ given by the averaging map

$$(v) \mapsto \frac{1}{|G|} \sum_{g \in G} g.v.$$

A generator $v_1 \otimes \dots \otimes v_n$ of $V^{\otimes n}$ is denoted (v_1, \dots, v_n) .

9.1 The Fundamental Theorems of Invariant Theory

We state the two fundamental theorems of invariant theory for the general linear group in their classical form.

9.1.1 The Fundamental Map μ . Let V be a finite dimensional k -vector space and let $GL(V)$ be its group of automorphisms. The left action of the symmetric group S_n on $V^{\otimes n}$ is given by place permutation

$$\sigma(v_1, \dots, v_n) = (v_{\sigma^{-1}(1)}, \dots, v_{\sigma^{-1}(n)}) .$$

Extending by linearity gives rise to a ring homomorphism $\mu : k[S_n] \rightarrow \text{End}(V^{\otimes n})$. Let $GL(V)$ act diagonally on $V^{\otimes n}$, that is $\alpha(v_1, \dots, v_n) = (\alpha(v_1), \dots, \alpha(v_n))$ for $\alpha \in GL(V)$, and by conjugation on $\text{End}(V^{\otimes n}) : \alpha(f) = \alpha \circ f \circ \alpha^{-1}$. Obviously the image of μ lies in the invariant algebra $\text{End}(V^{\otimes n})^{GL(V)}$. Our aim is to study the following algebra map and its dual

$$\mu : k[S_n] \rightarrow \text{End}(V^{\otimes n})^{GL(V)} .$$

9.1.2 Theorem (First Fundamental Theorem of Invariant Theory). *Let k be a characteristic zero field. The map $\mu : k[S_n] \rightarrow \text{End}(V^{\otimes n})^{GL(V)}$ is surjective.*

The proof is postponed to Sect.9.4. However we prove in 9.1.4 below a particular case for an infinite field (not necessarily of characteristic zero) under the assumption $\dim V \geq n$. To fully understand μ , it remains to compute its kernel. This is the object of the following

9.1.3 Theorem (Second Fundamental Theorem of Invariant Theory). *Let k be a characteristic zero field and let V be a vector space of dimension r . The kernel $\text{Ker}(\mu : k[S_n] \rightarrow \text{End}(V^{\otimes n})^{GL(V)})$ is*

- 0 if $r \geq n$,
- the two-sided ideal $J_{n,r}$ of $k[S_n]$ generated by

$$\varepsilon_{r+1} = \sum_{\sigma \in S_{r+1}} \text{sgn}(\sigma)\sigma , \quad \text{if } r < n .$$

In this formulation the embedding of S_r in S_n (when $r \leq n$) corresponds to the action of S_r on $\{1, \dots, r\}$. The proof is also postponed to Sect. 9.4.

The following corollary is the main ingredient of the theorem relating the homology of the Lie algebra of matrices with cyclic homology (Chap. 10). In

characteristic zero it follows immediately from 9.1.2 and 9.1.3, but we give an independent and elementary proof which has another advantage, it works without any characteristic assumption.

9.1.4 Corollary. *Let k be an infinite field and let V be a k -vector space with $\dim V = r \geq n$. Then $\mu : k[S_n] \rightarrow \text{End}(V^{\otimes n})^{GL(V)}$ is an isomorphism.*

Proof. Let e_1, \dots, e_r be a basis for V and let $f \in \text{End}(V^{\otimes n})^{GL(V)}$. Then $f(e_1, \dots, e_n)$ can be written as $\sum a_i(e_{i_1}, \dots, e_{i_n})$ where $a_i \in k$ and $\mathbf{i} = (i_1, \dots, i_n)$. Replacing e_1 by λe_1 for some $\lambda \in k$ multiplies $f(e_1, \dots, e_n)$ by λ . Therefore the sum is also multiplied by λ . As k is infinite, this shows that 1 appears once and only once in each n -tuple \mathbf{i} involved in the summation (and similarly for the other indices $2, \dots, n$). Hence \mathbf{i} is a permutation of $(1, \dots, n)$ and $f(e_1, \dots, e_n) = \sum a_\sigma \sigma(e_1, \dots, e_n)$, where the sum is extended over all $\sigma \in S_n$. We claim that $f = \sum a_\sigma \sigma$.

Indeed, for any other basis vector of $V^{\otimes n}$, there exists $\alpha \in \text{End}(V)$ such that this vector is $\alpha(e_1, \dots, e_n)$ (here we use $r \geq n$). Since f is $GL(V)$ -invariant, one has

$$\begin{aligned} f(\alpha(e_1, \dots, e_n)) &= \alpha(f(e_1, \dots, e_n)) \\ &= \alpha\left(\sum a_\sigma \sigma(e_1, \dots, e_n)\right) = \sum a_\sigma \sigma(\alpha(e_1, \dots, e_n)) \end{aligned}$$

as required.

This decomposition of f is unique because the vectors $\sigma(e_1, \dots, e_n)$, $\sigma \in S_n$, are linearly independent in $V^{\otimes n}$ thanks to the hypothesis $\dim V \geq n$. \square

Remark. In this proof we only use the fact that k is infinite. By a standard argument, this implies that the same assertion is true for $k = \mathbb{Z}$.

9.1.5 Corollary. *Let k be a characteristic zero field and let V be an $(n - 1)$ -dimensional k -vector space. Then there is an exact sequence*

$$0 \rightarrow k \xrightarrow{1 \mapsto \varepsilon_n} k[S_n] \xrightarrow{\mu} \text{End}(V^{\otimes n})^{GL(V)} \rightarrow 0.$$

Proof. By Theorem 9.1.2 μ is surjective. By Theorem 9.1.3 the kernel $J_{n,n-1}$ is generated by $\varepsilon_n \in k[S_n]$. This element satisfies $\varepsilon_n \sigma = \sigma \varepsilon_n = \text{sgn}(\sigma) \varepsilon_n$ for all $\sigma \in S_n$. Therefore the two-sided ideal generated by ε_n is one-dimensional, whence the exact sequence. \square

Exercise

E.9.1.1. Prove that Corollary 9.1.4 is valid for $k = \mathbb{Z}$ and V a free abelian group.

9.2 Coinvariant Theory and the Trace Map

The aim of this section is to translate the fundamental theorems of invariant theory into the coinvariant framework. The dualization introduces the trace map which plays a fundamental role.

9.2.1 The Trace Map T Revisited. Let $V^* = \text{Hom}(V, k)$ be the dual of the k -vector space V . Consider the two maps

$$\text{End}(V) \xleftarrow{\xi} V^* \otimes V \xrightarrow{\langle -, - \rangle} k$$

given by $\xi(\phi, v)(w) = \phi(w)v$, $v \in V$, $w \in V$, $\phi \in V^*$ and by $\langle \phi, v \rangle = \phi(v)$ respectively. If V is finite dimensional over k , then ξ is an isomorphism and the composite $\langle -, - \rangle \circ \xi^{-1}$ is nothing but the standard trace map: $\langle -, - \rangle \circ \xi^{-1} = \text{Tr}$.

From now on we assume that V is finite dimensional and therefore $V^{**} \cong V$. As a consequence there are canonical isomorphisms $(V \otimes V^*) \cong (V^* \otimes V)^*$ and $\text{End}(V) \cong \text{End}(V)^*$. Explicitly the pairing $\text{End}(V) \times \text{End}(V) \rightarrow k$ associated to the latter one is given by $\langle \alpha, \beta \rangle = \text{Tr}(\alpha\beta)$.

From this point of view, it is also immediate that $\text{End}(V^{\otimes n}) \cong \text{End}(V)^{\otimes n}$ (rearrange the factors V and V^*) and the pairing associated with the isomorphism $\text{End}(V)^{\otimes n} \cong (\text{End}(V)^{\otimes n})^*$ is simply $\langle (\alpha_1, \dots, \alpha_n), (\beta_1, \dots, \beta_n) \rangle = \text{Tr}(\alpha_1\beta_1) \dots \text{Tr}(\alpha_n\beta_n)$. Remark that the action of $GL = GL(V)$ on $\text{End}(V)^{\otimes n}$ is by diagonal conjugation: $g(\alpha_1, \dots, \alpha_n) = (g\alpha_1g^{-1}, \dots, g\alpha_ng^{-1})$.

We wish to give different formulations of the fundamental theorems by using these isomorphisms with dual spaces. First we note that for any G -module W the space $(W_G)^*$ is canonically isomorphic to $(W^*)^G$.

All the above isomorphisms assemble to give the following composite denoted T ,

$$k[S_n] \xrightarrow{\mu} \text{End}(V^{\otimes n})^{GL} \cong (\text{End}(V)^{\otimes n})^{GL} \cong ((\text{End}(V)^{\otimes n})^*)^{GL} \\ \cong ((\text{End}(V)^{\otimes n})_{GL})^* .$$

9.2.2 Proposition. *Let $\sigma = (i_1 \dots i_k)(j_1 \dots j_r) \dots (t_1 \dots t_s)$ be the cycle decomposition of $\sigma \in S_n$. Then the map T defined above is explicitly given by*

$$T(\sigma)(\alpha_1, \dots, \alpha_n) = \text{Tr}(\alpha_{i_1} \dots \alpha_{i_k}) \text{Tr}(\alpha_{j_1} \dots \alpha_{j_r}) \dots \text{Tr}(\alpha_{t_1} \dots \alpha_{t_s}) .$$

Proof. We freely use the fact that $\text{End}(V)$ is isomorphic to $V^* \otimes V$, where the product is given by $\psi \otimes w \cdot \phi \otimes v = \psi(v)\phi \otimes w$ and the trace map by $\text{Tr}(\phi \otimes v) = \phi(v)$.

As functions of $(\alpha_1, \dots, \alpha_n)$, both expressions in the proposition are multilinear, therefore it suffices to show that they agree on the generators $(\phi_1 \otimes v_1, \dots, \phi_n \otimes v_n)$.

On one hand we have

$$\begin{aligned} T(\sigma)(\phi_1 \otimes v_1, \dots, \phi_n \otimes v_n) &= \langle \mu(\sigma), (\phi_1 \otimes v_1, \dots, \phi_n \otimes v_n) \rangle \\ &= \prod_{i=1}^n \phi_{\sigma^{-1}(i)}(v_i) . \end{aligned}$$

The last equality follows from the formula $\langle \alpha, (\phi, v) \rangle = \phi(\alpha(v))$ pairing $\text{End}(V)$ and $V^* \otimes V$.

On the other hand we have

$$\begin{aligned} \text{Tr}(\alpha_{i_1} \dots \alpha_{i_k}) &= \text{Tr}(\phi_{i_1} \otimes v_{i_1} \cdot \phi_{i_2} \otimes v_{i_2} \cdot \dots \cdot \phi_{i_k} \otimes v_{i_k}) \\ &= \text{Tr}(\phi_{i_1}(v_{i_2}) \dots \phi_{i_{k-1}}(v_{i_k}) \phi_{i_k} \otimes v_{i_1}) \\ &= \phi_{i_1}(v_{i_2}) \phi_{i_2}(v_{i_3}) \dots \phi_{i_k}(v_{i_1}) \end{aligned}$$

and similarly for the other factors like $(\alpha_{j_1} \dots \alpha_{j_r})$.

So the right-hand side of the expected formula is precisely equal to $\prod_{i=1}^n \phi_i(v_{\sigma(i)})$ because $i_1 = \sigma(i_k)$, $i_2 = \sigma(i_1)$, etc.

Since the two sides of the expected formula agree on decomposable elements, they agree everywhere. \square

9.2.3 The Dual Map T^* . The k -module $k[S_n]$ is canonically isomorphic to its dual $k[S_n]^*$ since it comes with a preferred basis. For elements of S_n the scalar product is given by $(\sigma, \tau) \mapsto \delta_{\sigma\tau}$, where $\delta_{\sigma\tau}$ is the Kronecker symbol.

Consider the dual map

$$T^* : (\text{End}(V)^{\otimes n})_{GL} \rightarrow k[S_n]$$

obtained by dualizing T defined in 9.2.1 and composing with the isomorphism $k[S_n]^* \cong k[S_n]$.

From Proposition 9.2.2 it is clearly seen that

$$T^*(\alpha_1, \dots, \alpha_n) = \sum_{\sigma} T(\sigma)(\alpha_1, \dots, \alpha_n) \sigma \in k[S_n] .$$

In the sequel we state the fundamental theorems of invariant theory and in particular Corollaries 9.1.4 and 9.1.5 in the framework of Lie algebras.

9.2.4 The Lie Algebra Framework. The space $\text{End}(V)$ can be considered as a Lie algebra with Lie bracket given by $[\alpha, \beta] = \alpha\beta - \beta\alpha$. Then we write $gl(V)$ instead of $\text{End}(V)$. The Lie algebra $gl(V)$ is a module over itself (i.e. a module over the enveloping algebra $U(gl(V))$, cf. 10.1.2) and so is the tensor product $gl(V)^{\otimes n}$. More precisely, in this latter case, the right action is given by

$$[(\alpha_1, \dots, \alpha_n), \alpha] = \sum_{i=1}^n (\alpha_1, \dots, \alpha_{i-1}, [\alpha_i, \alpha], \alpha_{i+1}, \dots, \alpha_n) .$$

9.2.5 Lemma. *The module of coinvariants $(gl(V)^{\otimes n})_{gl(V)}$ is equal to the module $(gl(V)^{\otimes n})_{GL(V)}$ (which is also $(gl(V)^{\otimes n})_{SL(V)}$).*

Proof. This is a consequence of the reductivity of $SL(V)$, cf. A. Borel, Linear algebraic groups, Benjamin 1969, see §7. □

9.2.6 The Module $I_{n,r}$. Let $J_{n,r}$ be the two-sided ideal of $k[S_n]$ generated by ε_{r+1} (cf. Theorem 9.1.3). Dualizing this inclusion and identifying $k[S_n]$ with its dual we get an exact sequence

$$0 \rightarrow I_{n,r} \rightarrow k[S_n] \rightarrow J_{n,r}^* \rightarrow 0,$$

which defines $I_{n,r}$.

From the properties of $J_{n,r}$ we note that the family of modules $I_{n,r}$ forms a filtration of $k[S_n]$,

$$0 = I_{n,0} \subset I_{n,1} \subset \dots \subset I_{n,n-1} \subset I_{n,n} = I_{n,n+1} = \dots = k[S_n].$$

The choice of a basis for V permits us to identify $gl(V)$ with $gl_r(k)$, $r = \dim V$. The following assertions are translations of 9.1.3, 9.1.4 and 9.1.5.

9.2.7 Theorem. *Let k be a characteristic zero field. For any integer $r \geq 1$ the map*

$$T^* : (gl_r(k)^{\otimes n})_{gl_r(k)} \xrightarrow{\approx} I_{n,r},$$

is an isomorphism. □

9.2.8 Corollary. *Let k be an infinite field. The following S_n -equivariant map is an isomorphism for $r \geq n$,*

$$T^* : (gl_r(k)^{\otimes n})_{gl_r(k)} \xrightarrow{\approx} k[S_n]. \quad \square$$

9.2.9 Corollary. *Let k be a characteristic zero field. There is an exact sequence*

$$0 \rightarrow (gl_{n-1}(k)^{\otimes n})_{gl_{n-1}(k)} \xrightarrow{T^*} k[S_n] \xrightarrow{\text{sgn}} k \rightarrow 0$$

where sgn is the sign map ($\text{sgn}(\sum a_\sigma \sigma) = \sum a_\sigma \text{sgn}(\sigma)$). □

Note that T^* is S_n -equivariant for the action on $gl_r(k)^{\otimes n}$ by place permutation and the action on $k[S_n]$ by conjugation.

For future use let us prove the following result in which E_{ij} is the elementary matrix with 1 in the (i, j) -position and 0 everywhere else.

9.2.10 Lemma. *Let ω and σ be two permutations in S_n . The map T^* is such that*

$$T^*(E_{\omega(1)\sigma(1)}, \dots, E_{\omega(n)\sigma(n)}) = \sigma \circ \omega^{-1}.$$

In particular one has $T^*(E_{1\sigma(1)}, \dots, E_{n\sigma(n)}) = \sigma$.

Proof. Since $E_{ab}E_{cd} = 0$ if $b \neq c$ and $= E_{ad}$ if $b = c$, Proposition 9.2.2 implies that $T(\alpha)(E_{\omega(1)\sigma(1)}, \dots, E_{\omega(n)\sigma(n)}) = 1$ for

$$\alpha = (\omega(1) \sigma(1) = \omega(s) \sigma(s) = \omega(t) \dots)(\dots) \dots \in S_n,$$

and 0 otherwise. This permutation (described as a product of cycles above) is simply $\sigma \circ \omega^{-1}$. □

Exercises

E.9.2.1. For $\tau = (1\ 2 \dots n)$, prove that $\mu(\tau) = \sum E_{j_1 j_2} E_{j_2 j_3} \dots E_{j_n j_1}$ where the sum is extended over all possible sets of indices (j_1, j_2, \dots, j_n) .

E.9.2.2. Let $sl_n(k)$ be the Lie algebra of $n \times n$ -matrices with trace zero. Let S'_n be the subset of the symmetric group S_n consisting of permutations which have no 1-cycles (examples: $S'_2 = \{(12)\}$, $S'_3 = \{(123), (132)\}$). Prove that $(sl_r(k)^{\otimes n})_{sl_r(k)} \cong k[S'_n]$ for $r \geq n$.

E.9.2.3. Let y_{ij} , $1 \leq i, j \leq n$, be indeterminates and let T_n be the subspace of $k[y_{ij}]$ spanned by the monomials $y_{i_1 j_1} y_{i_2 j_2} \dots y_{i_n j_n}$ where $\{i_1, i_2, \dots, i_n\}$ and $\{j_1, j_2, \dots, j_n\}$ are permutations of $\{1, 2, \dots, n\}$. Prove that there is a canonical linear isomorphism between the space of multilinear trace expressions $\text{Tr}(x_{i_1} \dots x_{i_k}) \text{Tr}(x_{j_1} \dots x_{j_r}) \dots \text{Tr}(x_{t_1} \dots x_{t_s})$ and T_n . [The associated monomial is $y_{i_k i_1} y_{i_1 i_2} \dots y_{i_k j_r j_1} \dots \dots y_{t_s}$]. Let I_{r+1} be the ideal of $k[y_{ij}]$ generated by the $(r + 1) \times (r + 1)$ minors of the generic matrix $Y = (y_{ij})$. Prove that under the above identification the space of trace relations of $r \times r$ -matrices corresponds to $T_n \cap I_{r+1}$ (in other words $k[S_n] \cong T_n$, $\sigma \mapsto y_{1\sigma(1)} y_{2\sigma(2)} \dots y_{n\sigma(n)}$ and $I_{n,r} \cong T_n \cap I_{r+1}$).

9.3 Cayley-Hamilton and Amitsur-Levitzki Formulas

In this section we exhibit the relationship of invariant theory as treated before with the classical Cayley-Hamilton formula and the Amitsur-Levitzki formula. The Cayley-Hamilton formula is going to be used in the next section. The Amitsur-Levitzki formula, for which we give the proof by S. Rosset [1976], is closely related to the generator of $HC_{2n}(k)$.

9.3.1 Characteristic Polynomial. Let α be an $n \times n$ -matrix over k . By definition the *characteristic polynomial* of α is

$$P_n(\alpha, X) = \det(X id_n - \alpha) = X^n - \det_1(\alpha)X^{n-1} + \dots + (-1)^i \det_i(\alpha)X^{n-i} + \dots + (-1)^n \det_n(\alpha),$$

where X is an indeterminate and \det is the classical determinant.

It is well-known that $\det_1(\alpha) = \text{Tr}(\alpha)$ and that $\det_n(\alpha) = \det(\alpha)$. More generally we have the following

9.3.2 Lemma. *The coefficient $\det_i = \det_i(\alpha)$ is a homogeneous polynomial of degree i in $\text{Tr}(\alpha)$, $\text{Tr}(\alpha^2)$, \dots , $\text{Tr}(\alpha^i)$, where $\text{Tr}(\alpha^j)$ is of degree j . More precisely, with the notation of Sect. 9.2, we have*

$$\det_i(\alpha) = (1/i!)T(\varepsilon_i)(\alpha, \dots, \alpha) .$$

Proof. Embed k in an algebraic closure \hat{k} and suppose that α is diagonalizable. It is sufficient to treat the case where diagonalizable matrices are dense (for the Zariski topology) in the space of all $n \times n$ -matrices. By definition $\det_i(\alpha)$ is the i th elementary symmetric function of the eigenvalues $\lambda_1, \dots, \lambda_n$ of α . On the other hand $s_r(\alpha) = \text{Tr}(\alpha^r) = \lambda_1^r + \dots + \lambda_n^r$, is a symmetric function of the eigenvalues. Its expression in terms of the functions \det_i comes from Newton's formulas:

$$s_r - \det_1 s_{r-1} + \dots + (-1)^{r-1} \det_{r-1} s_1 + (-1)^r r \det_r = 0 . \quad \square$$

9.3.3 Remark. The expression of \det_i as a polynomial in $\text{Tr}(\alpha^j)$ does not depend on the size of α . For instance

$$\begin{aligned} \det_1(\alpha) &= T(\varepsilon_1)(\alpha) = \text{Tr}(\alpha) , \\ 2\det_2(\alpha) &= T(\varepsilon_2)(\alpha) = \text{Tr}(\alpha)^2 - \text{Tr}(\alpha^2) , \\ 6\det_3(\alpha) &= T(\varepsilon_3)(\alpha) = \text{Tr}(\alpha)^3 - 3\text{Tr}(\alpha)\text{Tr}(\alpha^2) + 2\text{Tr}(\alpha^3) . \end{aligned}$$

9.3.4 Proposition. *The Cayley-Hamilton formula for $n \times n$ -matrices is equivalent to the fundamental trace identity for $n \times n$ -matrices, that is $T(\varepsilon_{n+1})(\alpha_1, \dots, \alpha_{n+1}) = 0$.*

Proof. By Proposition 9.2.2 ε_{n+1} gives rise to a map $T(\varepsilon_{n+1})$ from $\text{End}(V)^{\otimes n+1}$ to k of the form $(\alpha_1, \dots, \alpha_{n+1}) \mapsto \text{Tr}(Q(\alpha_1, \dots, \alpha_n)\alpha_{n+1})$, where Q is some polynomial in n variables. One deduces immediately that

$$Q(\alpha, \dots, \alpha) = \sum_{i=0}^n (-1)^i \frac{n!}{i!} T(\varepsilon_i)(\alpha, \dots, \alpha) \alpha^{n-i} .$$

n times i times

Comparing with Lemma 9.3.2, we get $Q(\alpha, \dots, \alpha) = n!P_n(\alpha; \alpha)$. By the Cayley-Hamilton formula, which is $P_n(\alpha; \alpha) = 0$ for all $n \times n$ -matrices, we deduce $Q(\alpha, \dots, \alpha) = 0$ for all $n \times n$ -matrices α . Hence its multilinearization is also trivial on $n \times n$ -matrices. This implies that $T(\varepsilon_{n+1})$ is a zero functional when $\dim(V) = n$.

The converse is a consequence of the non-degeneracy of the trace map. \square

9.3.5 Example. For $n = 2$, $Q(\alpha_1, \alpha_2) = \alpha_1\alpha_2 + \alpha_2\alpha_1 - \text{Tr}(\alpha_1)\alpha_2 - \text{Tr}(\alpha_2)\alpha_1 - \text{Tr}(\alpha_1\alpha_2)Id + \text{Tr}(\alpha_1)\text{Tr}(\alpha_2)Id$, and then

$$\begin{aligned} \text{Tr}(Q(\alpha_1, \alpha_2)\alpha_3) &= \text{Tr}(\alpha_1\alpha_2\alpha_3) + \text{Tr}(\alpha_2\alpha_1\alpha_3) - \text{Tr}(\alpha_1)\text{Tr}(\alpha_2\alpha_3) \\ &\quad - \text{Tr}(\alpha_2)\text{Tr}(\alpha_1\alpha_3) - \text{Tr}(\alpha_1\alpha_2)\text{Tr}(\alpha_3) \\ &\quad + \text{Tr}(\alpha_1)\text{Tr}(\alpha_2)\text{Tr}(\alpha_3) \\ &= T(\varepsilon_3)(\alpha_1, \alpha_2, \alpha_3) . \end{aligned}$$

9.3.6 The Amitsur-Levitzki Identity. As seen before in the special case of the Cayley-Hamilton formula, there is an equivalence between elements in $J_{n,r}$ and multilinear matrix identities. We are interested here in the special case of the *Amitsur-Levitzki formula*. It corresponds to a particular element of $I_{2n+1,n}$ which is related to the canonical generator of $HC_{2n}(k)$.

9.3.7 Theorem (Amitsur-Levitzki Identity). *Let $\alpha_1, \dots, \alpha_{2n}$ be $n \times n$ -matrices over a commutative ring. Then*

$$\sum_{\sigma \in S_{2n}} \text{sgn}(\sigma)\alpha_{\sigma(1)}\alpha_{\sigma(2)} \dots \alpha_{\sigma(2n)} = 0 .$$

Proof. Let

$$S_r(\alpha_1, \dots, \alpha_r) = \sum_{\sigma \in S_r} \text{sgn}(\sigma)\alpha_{\sigma(1)}\alpha_{\sigma(2)} \dots \alpha_{\sigma(r)} .$$

As $S_{2n}(\alpha_1, \dots, \alpha_{2n})$ is a polynomial with integral coefficients in the entries of $\alpha_i, i = 1, \dots, 2n$, it suffices to show the Amitsur-Levitzki formula for matrices over a characteristic zero field k .

We first collect a few facts.

- (i) From the Cayley-Hamilton formula and Lemma 9.3.2 we deduce that, if α is an $n \times n$ -matrix over a commutative ring R such that $\text{Tr}(\alpha^i) = 0$ for all $i > 0$, then $\alpha^n = 0$.
- (ii) If r is even, then $\text{Tr}(S_r(\alpha_1, \dots, \alpha_r)) = 0$. This is an immediate consequence of the relation $\text{Tr}(\alpha_{i_1}\alpha_{i_2} \dots \alpha_{i_r} - \alpha_{i_2} \dots \alpha_{i_r}\alpha_{i_1}) = 0$.

Now let V be a $2n$ -dimensional vector space over k with basis e_1, \dots, e_{2n} . Consider the exterior algebra $\Lambda^*V = k \oplus V \oplus \Lambda V \oplus \Lambda^2V \oplus \dots$, and let R be the subalgebra of Λ^*V generated by $k = \Lambda^0V$ and Λ^2V . It is clear that R is central in Λ^*V and, a fortiori, commutative. Consider the $n \times n$ -matrix α over Λ^*V given by

$$\alpha = \alpha_1e_1 + \dots + \alpha_{2n}e_{2n} \in \mathcal{M}_n(V) \subset \mathcal{M}_n(\Lambda^*V) .$$

Its k th power in $\mathcal{M}_n(\Lambda^*V) \cong \mathcal{M}_n(k) \otimes \Lambda^*V$ is

$$\alpha^k = \sum_{i_1 < i_2 < \dots < i_k} S_k(\alpha_{i_1}, \dots, \alpha_{i_k}) e_{i_1} \wedge \dots \wedge e_{i_k} .$$

Obviously $\alpha^k = 0$ if $k > 2n$. Since we want to prove $S_{2n}(\alpha_1, \dots, \alpha_{2n}) = 0$, we have to look at $\alpha^{2n} = S_{2n}(\alpha_1, \dots, \alpha_{2n}) e_1 \wedge \dots \wedge e_{2n}$. From the equality $\alpha^{2n} = (\alpha^2)^n$ and the fact that the entries of α^2 are in the commutative ring R , we deduce from (i) that the relation $\alpha^{2n} = (\alpha^2)^n = 0$ is a consequence of $\text{Tr}(\alpha^2)^r = 0$ for all $r > 0$. From the expression of α^k above, this amounts to prove that $\text{Tr}(S_{2r}(\alpha_{i_1}, \dots, \alpha_{i_r})) = 0$, which is (ii). \square

We now translate this result into a statement about $I_{2n+1,n}$. Let $U_r \subset S_r$ be the conjugacy class of circular permutations, i.e. permutations σ such that $\sigma = g\tau g^{-1}$ for some $g \in S_r$ and $\tau = (12 \dots r)$. If r is odd, say $r = 2n + 1$, then $\text{sgn}(g)$ does not depend on g (for a fixed σ) and we denote this number by $a(\sigma)$.

9.3.8 Corollary. *The Amitsur-Levitzki element $\text{AL}_n := \sum_{\sigma \in U_{2n+1}} a(\sigma)\sigma$ lies in $I_{2n+1,n} \cap k[U_{2n+1}]$.*

Proof. The point is to prove that $\text{AL}_n \in I_{2n+1,n}$. Let us start with the Amitsur-Levitzki formula, and let α_{2n+1} be another $n \times n$ -matrix. Then

$$\text{Tr} \left(\sum_{g \in S_{2n}} \text{sgn}(g) \alpha_{g(1)} \dots \alpha_{g(2n)} \alpha_{2n+1} \right) = 0$$

for any set $(\alpha_1, \dots, \alpha_{2n+1})$ of $n \times n$ -matrices. But the left-hand side of this equality is precisely $T(\text{AL}_n)$ applied to $(\alpha_1, \dots, \alpha_{2n+1})$, so $T(\text{AL}_n) = 0$ and $\text{AL}_n \in \text{Ker } T = I_{2n+1,n}$. \square

9.3.9 Remark. Since $(\alpha, \beta) \mapsto \text{Tr}(\alpha\beta)$ is a non-degenerate bilinear form, the inclusion $\text{AL}_n \in I_{2n+1,n}$ implies the Amitsur-Levitzki formula. This is the way this formula is proved in B. Kostant's paper [1958] for instance.

9.3.10 Remark. It can be proved that $I_{2n+1,n} \cap k[U_{2n+1}]$ is in fact 1-dimensional (and so generated by AL_n).

Exercises

E.9.3.1. Let x_1, x_2, \dots, x_n be n indeterminates and put $t_i = x_1^i + x_2^i + \dots + x_n^i$. Show that $x_1 x_2 \dots x_n$ is a polynomial in t_1, \dots, t_n obtained as follows. In the expression of $e_n = (1/n!) \sum_{\sigma \in S_n} \text{sgn}(\sigma)\sigma$, replace each full cycle of length i by t_i . Example for $n = 3$ one gets $(1/6)(t_1 t_1 t_1 - t_2 t_1 - t_2 t_1 - t_2 t_1 + t_3 + t_3) = (1/6)(t_1^3 - 3t_2 t_1 + 2t_3)$.

E.9.3.2. The Mixed Discriminant. Let $\alpha_1, \dots, \alpha_n$ be $n \times n$ -matrices. For each permutation $\sigma \in S_n$ let $D(\sigma)$ be the determinant of the $n \times n$ -matrix whose i th row is the i th row of $\alpha_{\sigma(i)}$. The mixed discriminant is then defined by $D(\alpha_1, \dots, \alpha_n) = \sum_{\sigma \in S_n} D(\sigma)$. Show that $D(\beta\alpha_1\gamma, \dots, \beta\alpha_n\gamma) = (\det \gamma)(\det \beta)D(\alpha_1, \dots, \alpha_n)$. Show that it vanishes over $(n - 1) \times (n - 1)$ -matrices. Deduce its expression in terms of traces. [By Corollary 9.1.4 and Proposition 9.2.2 D is a scalar multiple of T_{ε_n} . Specializing to $\alpha_i = E_{ii}$ shows that this scalar is 1. Hence $D(\alpha_1, \dots, \alpha_n) = \sum_{\sigma \in S_n} \text{sgn}(\sigma)T_{\sigma}(\alpha_1, \dots, \alpha_n)$.]

E.9.3.3. For any integer n let

$$Q(x_1, \dots, x_n, y_1, \dots, y_n) = \sum \text{sgn}(\sigma\omega) (x_{\sigma(1)}y_{\omega(1)}x_{\sigma(2)}y_{\omega(2)} \cdots x_{\sigma(n)}y_{\omega(n)}) ,$$

where the sum is extended over all σ and $\omega \in S_n$.

Show that for any $n \times n$ -matrices $\alpha_1, \dots, \alpha_{2n}$ with coefficients in a commutative ring one has

$$Q_{2n}(\alpha_1, \dots, \alpha_{2n}) = 0$$

(due to Q. Chang on one hand and A. Giambruno and S.K. Sehgal on the other hand. See Formanek [1990, p. 8].)

9.4 Proofs of the Fundamental Theorems

The proofs of the fundamental theorems of invariant theory for the general linear case is classical. It uses the double centralizer theorem which we take for granted.

9.4.1 Proof of the First Fundamental Theorem. Let A be the image of $k[GL(V)]$ in $\text{End}(V^{\otimes n})$ (where $GL(V)$ acts diagonally) and let B be the image of $k[S_n]$ in $\text{End}(V^{\otimes n})$. We want to prove that the centralizer $Z(A)$ of A in $\text{End}(V^{\otimes n})$ is B .

As B is a product of full matrix algebras and $V^{\otimes n}$ is a faithful finitely generated representation of B , we can apply the *double centralizer theorem* (cf. for instance I. Reiner, *Maximal orders*, Corollary 7.10). It asserts that $Z(B) = A$ implies $Z(A) = B$. Let us prove the former equality. The centralizer of B is the symmetric algebra $S^n(\text{End}(V)) \subset \text{End}(V)^{\otimes n}$. On the other hand A is generated by the diagonal elements (α, \dots, α) , $\alpha \in \text{End}(V)$. The equality $Z(B) = A$ expresses the familiar fact that, rationally, a symmetric multilinear function is uniquely determined by the associated form (example: $\alpha \otimes \beta + \beta \otimes \alpha = (\alpha + \beta) \otimes (\alpha + \beta) - \alpha \otimes \alpha - \beta \otimes \beta$ is determined by the quadratic form $x \otimes x$). □

9.4.2 Representations of the Symmetric Group. We recall some elementary facts about the irreducible representations of the symmetric group

over a characteristic zero field. Let $\lambda = \{\lambda_1 \geq \lambda_2 \geq \dots \geq \lambda_n\}$ be a partition of $n = \lambda_1 + \lambda_2 + \dots + \lambda_n$. To any such partition is associated a *Young diagram* of n boxes, for instance for $\alpha = \{4, 2, 1, 0, 0, 0\}$ we get

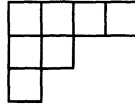

The irreducible representations of S_n are indexed by the partitions of n (or equivalently by the Young diagrams with n boxes).

A *standard Young tableau* t is a Young diagram filled in with the integers $\{1, 2, \dots, n\}$ in such a way that all rows and all columns are filled increasingly; examples:

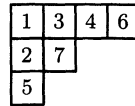
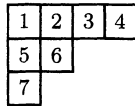

To each Young tableau t one can associate an idempotent in the group algebra $k[S_n]$, called the *Young symmetrizer* of t . It is defined as follows. Let R_t be the stabilizer of the rows (this is a subgroup of S_n) and similarly let C_t be the stabilizer of the columns. Then, put

$$\varepsilon_t = \frac{1}{\#C_t} \sum_{\sigma \in C_t} \text{sgn}(\sigma)\sigma \quad \text{and} \quad \eta_t = \frac{1}{\#R_t} \sum_{\sigma \in R_t} \sigma .$$

Observe that $(\varepsilon_t \eta_t)^2 = a \varepsilon_t \eta_t$ for some non-zero rational number a .

The Young symmetrizer of t is $\varepsilon_t \eta_t / a \in k[S_n]$. For instance the Young symmetrizer associated to the Young tableau which has only one column is $\varepsilon_n / n!$.

The regular representation of S_n , that is $A = k[S_n]$ viewed as an S_n -module via left multiplication, splits into isotypic components A_λ , $\lambda =$ partition of n . One can prove that the isotypic component A_λ is the sum of the images of the Young symmetrizers attached to the standard Young tableaux of shape λ . We denote by $A_{\geq r+1}$ the direct sum of the isotypic components A_λ for λ a Young diagram whose number of columns is more than or equal to $r + 1$.

Recall that the map $\mu : k[S_n] \rightarrow \text{End}(V^{\otimes n})^{GL(V)}$ sends a permutation to the endomorphism of V which permutes the coordinates accordingly.

9.4.3 Proof of the Second Fundamental Theorem. In order to prove that $J_{n,r} = \text{Ker } \mu$ (with $r = \dim V$) is equal to the two-sided ideal (ε_{r+1}) it is sufficient to prove the following

9.4.4 Lemma. *There are inclusions*

- (a) $(\varepsilon_{r+1}) \subset \text{Ker } \mu$
- (b) $\text{Ker } \mu \subset A_{\geq r+1}$
- (c) $A_{\geq r+1} \subset (\varepsilon_{r+1})$.

Proof. (a) Replace n by r in Proposition 9.3.4. Then the Cayley-Hamilton formula implies that $T(\varepsilon_{r+1})(\alpha_1, \dots, \alpha_n) = T(\varepsilon_{r+1})(\alpha_1, \dots, \alpha_r) \text{Tr}(\alpha_{r+1}) \dots \text{Tr}(\alpha_n) = 0$ for all sets of matrices $\alpha_1, \dots, \alpha_n$. Hence $\varepsilon_{r+1} \subset \text{Ker } T = \text{Ker } \mu$. Since $\text{Ker } \mu$ is a two-sided ideal we have $(\varepsilon_{r+1}) \subset \text{Ker } \mu$ as expected.

(b) Since μ is an algebra homomorphism, either $\mu(A_\lambda) \cong A_\lambda$ or $\mu(A_\lambda) = 0$ for a given partition λ . Let us prove that $\mu(A_\lambda) \neq 0$ when λ has no more than r columns. Consider a Young tableau t of shape λ . Let (e_1, \dots, e_r) be a basis for V . Let v_t be the monomial in $V^{\otimes n}$ which has e_i in tensor position j iff j occurs in row i of t (this is possible since the number of columns is $\leq r$). In our example of Young tableau above $v_t = (e_1, e_2, e_1, e_1, e_3, e_1, e_2)$.

By definition of v_t we have $\mu(\eta_t)(v_t) = (\#R_t)v_t$. So it is enough to show that $\mu(\varepsilon_t)(v_t) \neq 0$. But this is quite easy to see because, if $\gamma \in C_t, \gamma \neq id$, then $\mu(\gamma)(v_t)$ is another monomial $(e_{j_1}, \dots, e_{j_n})$ which is distinct from v_t . Thus $\mu(\varepsilon_t)(v_t) = v_t + (\text{other monomials}) \neq 0$.

(c) It is sufficient to prove that the Young symmetrizer of t whose shape has no less than r columns is in (ε_{r+1}) . First, ε_t is a multiple of $\sum \text{sgn}(\sigma)\sigma$ where the sum is extended over the stabilizer of the first column. But this column is of length $\geq r + 1$, so this element can be written as a sum of conjugates of ε_{r+1} . Hence the Young symmetrizer of any such tableau is in (ε_{r+1}) . □

9.5 Invariant Theory for the Orthogonal and Symplectic Groups

In this section we state the results of invariant theory necessary for the computation of the homology of the Lie algebras of orthogonal (9.5.1 to 9.5.6) and symplectic (9.5.7 to 9.5.13) matrices. We refer to Procesi [1976] for the proofs.

9.5.1 Notation. Let V be a finite dimensional vector space over the characteristic zero field k . Let $\langle -, - \rangle : V \times V \rightarrow k$ be a non-degenerate bilinear form on V . It induces an isomorphism $V \cong V^*, v \mapsto (w \mapsto \langle v, w \rangle)$. Hence $\text{End}(V)$ can be replaced by $V \otimes V$ and $\text{End}(V^{\otimes n})$ by $V^{\otimes n} \otimes V^{\otimes n} = V^{\otimes 2n}$. First we suppose that $\langle -, - \rangle$ is symmetric, $\langle v, w \rangle = \langle w, v \rangle$. By definition the orthogonal group $O(V)$ is the subgroup of $GL(V)$ such that

$$\alpha \in O(V) \Leftrightarrow \langle \alpha(v), \alpha(w) \rangle = \langle v, w \rangle .$$

The twisting map on $V \otimes V$ given by $v \otimes w \mapsto w \otimes v$ induces $\alpha \mapsto \alpha^t$ on $\text{End}(V)$. Obviously $\alpha \in O(V)$ iff $\alpha\alpha^t = id$.

Our aim is to describe the space of invariants $(\text{End}(V^{\otimes n})^*)^{O(V)}$. The first fundamental theorem claims that this space is spanned by the forms

$$(\alpha_1, \dots, \alpha_n) \mapsto \text{Tr}(x_{i_1} \dots x_{i_k}) \text{Tr}(x_{j_1} \dots x_{j_r}) \dots \text{Tr}(x_{m_1} \dots x_{m_s})$$

where $(i_1 \dots i_k)(j_1 \dots j_r) \dots (m_1 \dots m_s)$ is a permutation of $\{1, 2, \dots, n\}$ and x_i is either α_i or α_i^t .

Note that even if $\dim V$ is large these invariants are not independent. For instance $\text{Tr}(\alpha_1^t \alpha_2)$ and $\text{Tr}(\alpha_1 \alpha_2^t)$ give the same invariant map. In fact we will give another formulation, more precise and more suitable for our purposes.

As before the symmetric group S_n acts on $\text{End}(V^{\otimes n}) = \text{End}(V)^{\otimes n}$ by permuting the variables. But now we also have an action of $(\mathbb{Z}/2\mathbb{Z})^n$, the i th generator η_i acting by $\eta_i(\alpha_1, \dots, \alpha_n) = (\alpha_1, \dots, \alpha_{i-1}, \alpha_i^t, \alpha_{i+1}, \dots, \alpha_n)$. Combining these two actions yields an action of the hyperoctahedral group $H_n = (\mathbb{Z}/2\mathbb{Z})^n \rtimes S_n$ (semi-direct product). This group is considered as a subgroup of S_{2n} by letting S_n act diagonally, that is similarly on $\{1, 2, \dots, n\}$ and on $\{n+1, \dots, 2n\}$, and by letting η_i act by the transposition $(i \ n+i)$.

Consider now the polynomial algebra $k[y_{ij}]$ where i and j range over $\{1, \dots, 2n\}$. Let A_n be the subspace spanned by the monomials $y_{i_1 i_2} y_{i_3 i_4} \dots y_{i_{2n-1} i_{2n}}$ such that $\{i_1, \dots, i_{2n}\}$ is a permutation of $\{1, 2, \dots, 2n\}$. Obviously S_{2n} acts transitively on A_n . In fact any monomial is of the form $\sigma(y_{1 \ n+1} y_{2 \ n+2} \dots y_{n \ 2n})$ for some $\sigma \in S_{2n}$. The isotropy subgroup of the monomial $y_{1 \ n+1} y_{2 \ n+2} \dots y_{n \ 2n}$ is precisely H_n . Therefore there is a canonical isomorphism $k[S_{2n}/H_n] \cong A_n$.

9.5.2 Theorem (First Fundamental Theorem for the Orthogonal Group). *The composite map*

$$T : k[S_{2n}/H_n] \cong A_n \rightarrow ((V^{\otimes 2n})^*)^{O(V)} \cong (\text{End}(V^{\otimes n})^*)^{O(V)}$$

induced by $y_{i_1 i_2} y_{i_3 i_4} \dots y_{i_{2n-1} i_{2n}} \mapsto ((v_1, \dots, v_{2n}) \mapsto \langle v_{i_1}, v_{i_2} \rangle \dots \langle v_{i_{2n-1}}, v_{i_{2n}} \rangle)$ is surjective.

Proof. Cf. Procesi [1976, p. 326]. □

9.5.3 Remark. The group H_n is acting on S_{2n}/H_n by left multiplication (or equivalently by conjugation) and is acting on the space $(\text{End}(V^{\otimes n})^*)^{O(V)}$ (see above). It is immediate to verify that T is H_n -equivariant.

9.5.4 Remark. To compare with the formulation in terms of traces, show that for $n = 2$ the images of (1)(2)(3)(4), (12)(3)(4) and (14)(2)(3) are respectively $\text{Tr}(\alpha_1)\text{Tr}(\alpha_2)$, $\text{Tr}(\alpha_1\alpha_2)$, $\text{Tr}(\alpha_1\alpha_2^t)$.

For any irreducible representation of S_{2n} associated to a partition λ , we denote by $(A_n)_\lambda$ the isotypic component of A_n .

9.5.5 Theorem (Second Fundamental Theorem for the Orthogonal Group). *The kernel of the map $T : k[S_{2n}/H_n] \cong A_n \rightarrow (\text{End}(V^{\otimes n})^*)^{O(V)}$ is the sum of the isotypic components $(A_n)_\lambda$, $\lambda = \{\lambda_1, \dots, \lambda_n\}$, such that $\lambda_1 \geq \dim V + 1$. In particular T is an isomorphism as soon as $\dim V \geq n$. \square*

9.5.6 Remark. When $\dim V = n - 1$ the only Young diagram involved is

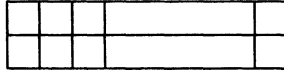

We now translate the stable results needed in Sect. 10.5 in terms of Lie algebras. Let $\dim V = r$ and choose the standard symmetric bilinear form on V . Then the Lie algebra $\mathfrak{o}(V)$ of skew-symmetric matrices ($\alpha^t + \alpha = 0$), is denoted $\mathfrak{o}_r(k)$.

9.5.7 Corollary. *Let k be a characteristic zero field. The H_n -equivariant map $T^* : (\mathfrak{gl}_r(k)^{\otimes n})_{\mathfrak{o}_r(k)} \rightarrow k[S_{2n}/H_n]$ is an isomorphism when $r \geq 2n$. \square*

Remark. We would like to be able to describe the first non-stable case, that is the cokernel of T^* when $r = n - 1$. This means getting a description of $J_{n,n-1}$ in the orthogonal case. But there is no such nice description like in 9.3.3, because here $J_{n,n-1}$ is of dimension > 1 .

9.5.8 The Symplectic Case. We now treat the case of an antisymmetric non-degenerate bilinear form $\langle -, - \rangle : V \times V \rightarrow k$. It is similar to the previous case, with some extra information concerning the Pfaffian.

The isomorphism $V \otimes V \rightarrow V \otimes V, v \otimes w \mapsto -w \otimes v$ induces an involution on $\text{End}(V) \cong V^* \otimes V \cong V \otimes V$, which is denoted by $\alpha \mapsto \alpha^a$. Let $Sp(V) = \{\alpha \in GL(V) \mid \langle \alpha(v), \alpha(w) \rangle = \langle v, w \rangle\}$ be the symplectic group and $\mathfrak{sp}(V)$ be the associated Lie algebra.

The first fundamental theorem has almost the same shape as in the orthogonal case, except that α^a replaces α^t . The polynomial algebra is now $k[y_{ij}]$ with $y_{ij} = -y_{ji}$ and $y_{ii} = 0$. The space spanned by the monomials $y_{i_1 i_2} y_{i_3 i_4} \dots y_{i_{2n-1} i_{2n}}$, where $\{i_1, \dots, i_{2n}\}$ is a permutation of $\{1, \dots, 2n\}$, is denoted A_n^{-1} . Note that there is an isomorphism of S_{2n} -modules $A_n^{-1} \cong A_n \otimes (\text{sgn})$, where (sgn) is the one dimensional sign representation.

9.5.9 Theorem. (First Fundamental Theorem for the Symplectic Group). *The composite map*

$$T : k[S_{2n}/H_n] \cong A_n^{-1} \rightarrow ((V^{\otimes 2n})^*)^{Sp(V)} \cong (\text{End}(V^{\otimes n})^*)^{Sp(V)}$$

induced by

$$y_{i_1 i_2} y_{i_3 i_4} \dots y_{i_{2n-1} i_{2n}} \mapsto ((v_1, \dots, v_{2n}) \mapsto \langle v_{i_1}, v_{i_2} \rangle \dots \langle v_{i_{2n-1}}, v_{i_{2n}} \rangle)$$

is surjective.

Proof. Cf. Procesi [1976, p. 340]. □

9.5.10 Remark. The action of H_n on $k[S_{2n}/H_n]$ is now by left multiplication and multiplication by the sign (through the inclusion $H_n \subset S_{2n}$). Thus T is H_n -equivariant. Note that, as an S_{2n} -module, A_n^{-1} decomposes as a direct sum $\bigoplus_{\lambda}(A_n^{-1})_{\lambda}$ where λ has an even number of columns.

9.5.11 Theorem (Second Fundamental Theorem for the Symplectic Group). *The kernel of the map $T : k[S_{2n}/H_n] \cong A_n^{-1} \rightarrow (\text{End}(V^{\otimes n})^*)^{Sp(V)}$ is the sum of the isotypic components $(A_n^{-1})_{\lambda}$, $\lambda = \{\lambda_1, \dots, \lambda_n\}$ such that $\lambda_1 \geq (1/2)\dim V + 2$. In particular T is an isomorphism as soon as $\dim V \geq 2n$.*

Proof. Cf. Procesi [1976]. □

The translation in the coinvariant framework gives the following

9.5.12 Proposition. *Let k be a characteristic zero field. The H_n -equivariant map $T^* : (gl_{2r}(k)^{\otimes n})_{sp_{2r}(k)} \rightarrow k[S_{2n}/H_n]$ is an isomorphism when $r \geq n$. □*

Remember that the H_n -structure of $k[S_{2n}/H_n]$ is by multiplication on the left and multiplication by the sign.

9.5.13 The Pfaffian. Let $\alpha = (\alpha_{ij})$ be a $2n \times 2n$ antisymmetric matrix. By definition the *Pfaffian* of α is the element

$$\text{Pf}(\alpha) := \sum_{\sigma \in \Phi} \text{sgn}(\sigma) \alpha_{\sigma(1)\sigma(2)} \cdots \alpha_{\sigma(2n-1)\sigma(2n)},$$

where $\Phi = \{\sigma \in S_{2n} \mid \sigma(1) < \sigma(3) < \dots < \sigma(2n-1) \text{ and } \sigma(2i-1) < \sigma(2i) \text{ for all } i\}$. For example

$$\begin{aligned} \text{Pf} \begin{bmatrix} 0 & \alpha \\ -\alpha & 0 \end{bmatrix} &= \alpha \quad \text{and} \\ \text{Pf} \begin{bmatrix} 0 & \alpha_{12} & \alpha_{13} & \alpha_{14} \\ -\alpha_{12} & 0 & \alpha_{23} & \alpha_{24} \\ -\alpha_{13} & -\alpha_{23} & 0 & \alpha_{34} \\ -\alpha_{14} & -\alpha_{24} & -\alpha_{34} & 0 \end{bmatrix} &= \alpha_{12}\alpha_{34} - \alpha_{13}\alpha_{24} + \alpha_{14}\alpha_{23}. \end{aligned}$$

Note that Φ is a set of representatives for the classes of S_{2n}/H_n . If we take for α the generic matrix $y = [y_{ij}]_{1 \leq i, j \leq 2n}$ then $\text{Pf}(y)$ is an element of A_n^{-1} and under the isomorphism described above can be considered as an element of $k[S_{2n}/H_n]$. The Pfaffian plays the following role in invariant theory.

The first unstable case is for $\dim V = 2r = 2(n-1)$. Then the kernel of T^* corresponds to

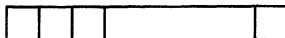

and therefore is one-dimensional (as in the linear case). It is generated (as an element of A_n^{-1}) by the Pfaffian of the generic antisymmetric matrix $[y_{ij}]_{1 \leq i, j \leq 2n}$.

The translation of these results in terms of Lie algebras is as follows. For $V = k^{2r}$ we choose the symplectic form $J_r = j \oplus \dots \oplus j$, where

$$j = \begin{bmatrix} 0 & 1 \\ -1 & 0 \end{bmatrix},$$

and we put $sp(V) = sp_{2r}(k)$.

9.5.14 Proposition. *Let k be a characteristic zero field. There is an exact sequence*

$$0 \rightarrow (gl_{2n-2}(k)^{\otimes n})_{sp_{2n-2}(k)} \rightarrow k[S_{2n}/H_n] \xrightarrow{\text{Pf}^*} k \rightarrow 0$$

where Pf^* is dual to the Pfaffian. □

Exercises

E.9.5.1. Show that in terms of elementary matrices E_{ij} we have $\mu(\sigma) = \sum (E_{i_1 i_{\sigma(1)}}, E_{i_2 i_{\sigma(2)}}, \dots, E_{i_n i_{\sigma(n)}})$ where the sum is extended over all possible sets of indices $\{i_1, \dots, i_n\}$. Similarly in the orthogonal framework show that

$$\mu(\sigma) = \sum (F_{i_{\sigma(1)} i_{\sigma(n+1)}}, F_{i_{\sigma(2)} i_{\sigma(n+2)}}, \dots, F_{i_{\sigma(n)} i_{\sigma(2n)}}), \sigma \in S_{2n},$$

where $F_{ij} = (1/2)(E_{ij} + E_{ji})$.

E.9.5.2. Show that $(\text{End}(V)^{\otimes 2})^{\mathcal{O}(V)}$ is isomorphic to the commutative algebra generated by a and b with the relations $a^2 = 1$ and $b^2 = b$, when $\dim V \geq 2$.

E.9.5.3. Let α be a skew-symmetric matrix of dimension $2n$. Show that $\det(\alpha) = \text{Pf}(\alpha)^2$.

Bibliographical Comments on Chapter 9

The main reference for classical invariant theory is undoubtedly H. Weyl’s book entitled “Classical groups”. However, as R. Howe says, “most people who know the book feel the material in it is wonderful. Many also feel the presentation is terrible.” Among the difficulties to read that book is the fact that the notion of tensor product was not fully understood at that time (1946). For instance there is no \otimes sign in this book.

There is a lot of ways to present invariant theory. One can work with polynomial functions, or multilinear functions. The emphasis can be put on the algebra structure or on the S_n -module structure. Some people take bases, some others work

intrinsically. As a result it is often difficult to make the connection between different papers.

Of course we also made a choice here. But we tried to show how taking the dual gives different versions of invariant theory. Our main references are C. Procesi [1976, 1979]. For a characteristic free treatment see de Concini and C. Procesi, [1976].

For the Amitsur-Levitzki formula we give the (very elegant) proof due to S. Rosset [1976]. In our context the reader might like to read B. Kostant [1958].

Note that the first appendix of Atiyah-Bott-Patodi [1973] contains a quick way of deducing the first fundamental theorem for the orthogonal group from its analogue for the general linear group.

After writing this chapter I came across the excellent short monography of E. Formanek [1990] on the subject.

Chapter 10. Homology of Lie Algebras of Matrices

One of the main properties of cyclic homology is its relationship with the homology of the Lie algebra of matrices. Explicitly it takes the following form. For any unital associative algebra A over a characteristic zero field k , there is a canonical isomorphism of graded Hopf algebras

$$H_*(gl(A), k) \cong \Lambda(HC_*(A)[1]) .$$

The left-hand side is the homology of the Lie algebra of matrices over A with coefficients in k and the right-hand side is the graded symmetric algebra of cyclic homology (considered as a graded vector space shifted by 1). Another way of stating this result is in terms of the primitive part of these Hopf algebras,

$$\text{Prim } H_*(gl(A)) \cong HC_{*-1}(A) .$$

The point in this main theorem is the absence of matrices in the definition of $HC_*(A)$, which makes it far easier to compute than the homology of $gl(A)$. Obtained as an attempt to compute algebraic K -theory this result was discovered independently and simultaneously by Loday-Quillen [1983, LQ] and Tsygan [1983].

In several problems, what is needed is the computation of the homology of $gl_r(A)$ for a fixed integer r . This is a more complicated problem, which has not yet been completely solved. However, in Loday-Quillen [LQ] we proved some stability results in this direction,

$$H_n(gl_n(A)) \xrightarrow{\sim} H_n(gl_{n+1}(A)) \xrightarrow{\sim} \dots \xrightarrow{\sim} H_n(gl(A)) ,$$

and we computed the first obstruction to stability. In the commutative case, this computation takes the form of an exact sequence

$$H_n(gl_{n-1}(A)) \rightarrow H_n(gl_n(A)) \rightarrow \Omega_{A|k}^{n-1} / d\Omega_{A|k}^{n-2} \rightarrow 0 .$$

The computation of $H_n(gl_r(A))$ for $r < n$ is not yet achieved and in 10.3.9 we propose a conjecture in terms of the λ -decomposition of $HC_*(A)$.

Similar computations can be worked out with the adjoint representation as coefficients, and also with the orthogonal and symplectic algebra in place of the Lie algebra of all matrices. For these last cases cyclic homology has to be replaced by dihedral homology.

For a long time I was hoping for a similar result with Hochschild homology in place of cyclic homology. The question was: what is going to play the role of the homology of $gl(A)$? The answer came from the following simple, but striking fact, that I discovered in January 1989:

“The Chevalley-Eilenberg boundary map on the exterior algebra $\Lambda\mathfrak{g}$ can be lifted to the tensor algebra $T\mathfrak{g}$ into a (new) boundary map”.

This gives rise to a new complex $(T\mathfrak{g}, d)$ whose homology is denoted $HL_*(\mathfrak{g})$ and called *non-commutative homology of the Lie algebra* \mathfrak{g} . Then, the relationship with Hochschild homology is an isomorphism

$$HL_*(gl(A)) \cong T(HH_*(A)[1]) .$$

The main tool, in the proof of this theorem, was constructed by C. Cuvier [1991].

Section 10.1 is concerned with the general properties of Lie algebra homology and cohomology. It is a classical topic which can be found in textbooks (cf. Cartan-Eilenberg [CE], Koszul [1958]).

Section 10.2 contains the proof of the main theorem which computes $H_*(gl(A))$ in terms of cyclic homology. One of the main inputs is the isomorphism $(gl^{\otimes n})_{gl} \cong k[S_n]$ proved in the preceding chapter on invariant theory.

Section 10.3 contains the proof of the stability results. Again invariant theory plays a crucial role.

Section 10.4 describes the computation when the coefficients are in the adjoint representation.

In Sect. 10.5 $gl(A)$ is replaced by the Lie algebra of skew-symmetric matrices $\mathfrak{o}(A)$ and symplectic matrices $\mathfrak{sp}(A)$. Then cyclic homology is replaced by dihedral homology (in both cases). The main change in the proof is the call to other results of invariant theory which are slightly more complicated.

Section 10.6 contains the most recent results in this framework. It concerns the non-commutative version of Lie algebra homology. First we show that the Chevalley-Eilenberg boundary map can be lifted from the exterior module to the tensor module. Then the proof of the main theorem which computes $HL_*(gl(A))$ in terms of $HH_*(A)$ begins as in the Lie case. However this method gives a new complex which is bigger than the Hochschild complex. The second part of the proof consists in proving that these two complexes are quasi-isomorphic. Stability properties and the obstruction to stability are as expected.

Standing Notation. For any non-negatively graded module $M = \bigoplus_{n \geq 0} M_n$ the graded symmetric algebra of M is denoted ΛM (cf. Appendix A.1). If the grading of M is not specified it is understood that M is concentrated in degree 1 (if in degree zero, then we adopt the notation $S(M)$). For instance $\Lambda\mathfrak{g}$ (also denoted $\Lambda^*\mathfrak{g}$) is $E^n\mathfrak{g}$ in degree n .

Standing Assumption. In this chapter A is always supposed to be unital unless otherwise stated.

10.1 Homology of Lie Algebras

In this section we recall the fundamentals of the homology and cohomology of Lie algebras. We also state and prove some technical general results which are going to be used later. Among them is the triviality of the adjoint action on the homology (and also cohomology) and the fact (due to J.-L. Koszul) that taking the coinvariants under the action of a reductive sub-Lie algebra does not change the homology.

All this material is standard and can be found in textbooks. The only original idea is formula (10.1.3.3), which is going to play a fundamental role in Sect. 10.6.

10.1.1 Lie Algebras and Modules. A *Lie algebra* over k is a k -module \mathfrak{g} equipped with a k -bilinear map

$$[-, -] : \mathfrak{g} \times \mathfrak{g} \rightarrow \mathfrak{g}$$

called the *Lie bracket*, which satisfies the following two conditions:

- (a) antisymmetry: $[x, x] = 0$ for all $x \in \mathfrak{g}$.
- (b) Jacobi identity: $[x, [y, z]] + [y, [z, x]] + [z, [x, y]] = 0$, for all $x, y, z \in \mathfrak{g}$.

Note that (a) implies: $[x, y] = -[y, x]$, for all x and $y \in \mathfrak{g}$.

One of the main examples comes from associative algebras. Let R be an associative algebra over k . Then the (additive) commutator $[x, y] = xy - yx$ is a Lie bracket (everybody must verify this at least once in his/her lifetime) and so R becomes a Lie algebra over k .

A *Lie algebra homomorphism* $f : \mathfrak{g}' \rightarrow \mathfrak{g}$ is a k -module map which respects the Lie bracket.

A *right module* V over \mathfrak{g} is a k -module equipped with a bilinear map

$$[-, -] : V \times \mathfrak{g} \rightarrow V,$$

satisfying

$$(10.1.1.1) \quad [v, [x, y]] = [[v, x], y] - [[v, y], x] \quad \text{for all } v \in V \text{ and all } x, y \in \mathfrak{g}.$$

Such a module is also called a *representation* of the Lie algebra \mathfrak{g} . For instance let $V = \mathfrak{g}$ and let the action be the Lie bracket (same notation). Then the relation (10.1.1.1) is, modulo the antisymmetry property, equivalent to the Jacobi identity. This is called the *adjoint representation* of \mathfrak{g} and denoted \mathfrak{g}^{ad} . The adjoint action can be extended to the tensor product $\mathfrak{g}^{\otimes n}$ and to the exterior product $\Lambda^n \mathfrak{g}$ by the formulas

$$(10.1.1.2) \quad [(g_1, \dots, g_n), g] = \sum_{i=1}^n (g_1, \dots, [g_i, g], \dots, g_n),$$

$$(10.1.1.3) \quad [(g_1 \wedge \dots \wedge g_n), g] = \sum_{i=1}^n (g_1 \wedge \dots \wedge [g_i, g] \wedge \dots \wedge g_n).$$

For $V = k$ the *trivial representation* of \mathfrak{g} on k is given by $[v, g] = 0$ for $v \in V$ and $g \in \mathfrak{g}$.

10.1.2 Universal Enveloping Algebra. The *universal enveloping algebra* $U(\mathfrak{g})$ of the Lie algebra \mathfrak{g} is an associative algebra constructed as follows. Let $T(\mathfrak{g})$ be the tensor algebra over the k -module \mathfrak{g} . Then $U(\mathfrak{g})$ is the quotient of $T(\mathfrak{g})$ by the two-sided ideal generated by the elements $g \otimes h - h \otimes g - [h, g]$ for all $g, h \in \mathfrak{g}$. Note that a module over \mathfrak{g} is nothing but a $U(\mathfrak{g})$ -module in the ordinary sense. The functor U is left adjoint to the functor $A \mapsto A_L$, where $A_L = A$ as a k -module and the Lie bracket of A_L is given by $[a, b] = ab - ba$.

10.1.3 The Chevalley-Eilenberg Complex. Let \mathfrak{g} be a Lie algebra over k and let V be a \mathfrak{g} -module. Consider the following sequence of maps

$$(10.1.3.1) \quad \dots \rightarrow V \otimes \Lambda^n \mathfrak{g} \xrightarrow{d} V \otimes \Lambda^{n-1} \mathfrak{g} \xrightarrow{d} \dots \xrightarrow{d} V \otimes \Lambda^1 \mathfrak{g} \xrightarrow{d} V,$$

where $\Lambda^n \mathfrak{g}$ is the n th exterior power of \mathfrak{g} over k , and where the map d is given classically by the formula

$$(10.1.3.2) \quad \begin{aligned} d(v \otimes g_1 \wedge \dots \wedge g_n) := & \sum_{1 \leq j \leq n} (-1)^j [v, g_j] \otimes g_1 \wedge \dots \wedge \widehat{g}_j \wedge \dots \wedge g_n \\ & + \sum_{1 \leq i < j \leq n} (-1)^{i+j-1} v \otimes [g_i, g_j] \wedge g_1 \wedge \dots \wedge \widehat{g}_i \wedge \dots \wedge \widehat{g}_j \wedge \dots \wedge g_n. \end{aligned}$$

As usual \widehat{g}_i means that the variable g_i has been deleted. It was checked (indirectly) in 3.3.3 (where d was denoted δ) that $d^2 = 0$. Another proof will be given in 10.6.3. The complex (10.1.3.1) is called the *Chevalley-Eilenberg complex* (CE complex for short), sometimes denoted $C_*(\mathfrak{g}, V)$.

There is a way of expressing d by a more homogeneous formula. Let us put $v = g_0$ (though $g_0 \in V$) and write (g_0, \dots, g_n) in place of $(g_0 \otimes g_1 \wedge \dots \wedge g_n)$. Then formula (10.1.3.2) can be written

$$(10.1.3.3) \quad d(g_0, \dots, g_n) := \sum_{0 \leq i < j \leq n} (-1)^j (g_0, g_1, \dots, g_{i-1}, [g_i, g_j], g_{i+1}, \dots, \widehat{g}_j, \dots, g_n).$$

Remark. Note that though $\Lambda \mathfrak{g}$ is an algebra, $(\Lambda \mathfrak{g}, d)$ is *not* a DG-algebra. However it is a DG-coalgebra (cf. Appendix A).

10.1.4 Homology of a Lie Algebra. The homology groups of the Chevalley-Eilenberg complex are denoted $H_n(\mathfrak{g}, V)$ and called the *homology groups of the Lie algebra \mathfrak{g} with coefficients in the module V* . As usual $H_*(\mathfrak{g}, V) := \bigoplus_{n \geq 0} H_n(\mathfrak{g}, V)$. Any Lie algebra homomorphism $f : \mathfrak{g}' \rightarrow \mathfrak{g}$ induces a map $H_n(\mathfrak{g}', f^*V) \rightarrow H_n(\mathfrak{g}, V)$, where f^*V is V viewed as a \mathfrak{g}' -module via f .

When $V = k$ is the trivial module we simply write $H_n(\mathfrak{g})$ instead of $H_n(\mathfrak{g}, k)$. In this case the formula for d is simpler since the first summation term in formula (10.1.3.2) disappears. Note that the module of n -chains is simply $\Lambda^n \mathfrak{g}$ in that case (identify $1 \otimes g_1 \wedge \dots \wedge g_n$ with $g_1 \wedge \dots \wedge g_n$).

10.1.5 Some Properties of $H_*(\mathfrak{g}, V)$. There is a Tor-interpretation of the Lie homology groups. Suppose that \mathfrak{g} is projective over k (as a k -module), then there is a canonical isomorphism

$$H_*(\mathfrak{g}, V) \cong \text{Tor}_*^{U(\mathfrak{g})}(V, k),$$

where k is a module over the universal enveloping algebra $U(\mathfrak{g})$ via the augmentation map (trivial \mathfrak{g} -structure) (cf. Cartan-Eilenberg [CE]).

On the other hand, if $V = M^{\text{ad}}$ for a certain $U(\mathfrak{g})$ -bimodule M , then Theorem 3.3.2 provides an isomorphism

$$(10.1.5.1) \quad \varepsilon_* : H_*(\mathfrak{g}, M^{\text{ad}}) \cong H_*(U(\mathfrak{g}), M),$$

which is induced by the antisymmetrization map ε .

In low dimension the homology groups are given by

$$H_0(\mathfrak{g}, V) = V_{\mathfrak{g}} = V/\{[v, g] \mid v \in V, g \in \mathfrak{g}\}, \text{ hence } H_0(\mathfrak{g}) = k, \\ H_1(\mathfrak{g}) = \mathfrak{g}/[\mathfrak{g}, \mathfrak{g}], \text{ which is also denoted } \mathfrak{g}_{ab}.$$

Suppose that \mathfrak{g} and $H_*(\mathfrak{g})$ are projective over k (e.g. k is a field). Then, by the Künneth theorem, there is a canonical isomorphism $H_*(\mathfrak{g} \oplus \mathfrak{g}) \cong H_*(\mathfrak{g}) \otimes H_*(\mathfrak{g})$. Its composition with the morphism induced by the diagonal map $\Delta : \mathfrak{g} \rightarrow \mathfrak{g} \oplus \mathfrak{g}$ endows $H_*(\mathfrak{g})$ with a structure of cocommutative graded coalgebra (cf. Appendix A). Our main task in the next section will be to compute the primitive part of this coalgebra when \mathfrak{g} is the Lie algebra of matrices.

10.1.6 Cohomology of a Lie Algebra. The cohomological version is defined as follows. The *Chevalley-Eilenberg cochain complex* is

$$\dots \rightarrow \text{Hom}_k(\Lambda^n \mathfrak{g}, V) \xrightarrow{\delta} \text{Hom}_k(\Lambda^{n+1} \mathfrak{g}, V) \rightarrow \dots$$

where the coboundary map δ is given by

$$\delta f(g_1, \dots, g_{n+1}) := \sum_{i=1}^{n+1} (-1)^i [f(g_1, \dots, \widehat{g}_i, \dots, g_{n+1}), g_i] \\ + \sum_{1 \leq i < j \leq n+1} (-1)^{i+j} f([g_i, g_j], g_1, \dots, \widehat{g}_i, \dots, \widehat{g}_j, \dots, g_{n+1}).$$

The cohomology groups are denoted $H^n(\mathfrak{g}, V)$ and $H^n(\mathfrak{g})$ if $V = k$ with trivial \mathfrak{g} -module structure. The interpretation in terms of derived functors (when \mathfrak{g} is a projective k -module) is given by

$$H^*(\mathfrak{g}, V) \cong \text{Ext}_{U(\mathfrak{g})}^*(k, V).$$

The lowest cohomology groups are given by

$$H^0(\mathfrak{g}, V) = V^{\mathfrak{g}} = \{v \in V \mid [v, g] = 0, g \in \mathfrak{g}\}, \text{ hence } H^0(\mathfrak{g}) = k, \\ H^1(\mathfrak{g}) = \text{Hom}(\mathfrak{g}_{ab}, k).$$

Note that the diagonal map and the Künneth theorem permit us to define a graded algebra structure on $H^*(\mathfrak{g})$ when \mathfrak{g} and $H^*(\mathfrak{g})$ are projective over k . The indecomposable part is

$$\text{Indec } H^*(\mathfrak{g}) = H^*(\mathfrak{g}) / \tilde{H}^*(\mathfrak{g}) \cdot \tilde{H}^*(\mathfrak{g}),$$

where $\tilde{H}^*(\mathfrak{g})$ means *reduced cohomology*, i.e. $\tilde{H}^* = H^*/H^0$ in this case.

The relationship with Lie groups, which historically gave rise to this notion of Lie algebra cohomology, is as follows. Let G be a compact Lie group and let \mathfrak{g} denote its Lie algebra (over $k = \mathbb{C}$). The de Rham complex $\Omega^*(G)$ of differential forms on G is endowed with an action of G and the invariant space $\Omega^*(G)^G$ is a subcomplex. It turns out that there is a canonical isomorphism $\Omega^n(G)^G \cong \Lambda^n(\mathfrak{g}^*)$ such that the exterior differential map d of the de Rham complex becomes precisely the boundary map of the CE cochain complex. As a result there are canonical isomorphisms

$$H^*(\mathfrak{g}) \cong H^*(\Omega^*(G)^G) \cong H^*(G),$$

where the latter group is de Rham (or singular) cohomology of the manifold G .

The remaining part of this section consists in proving properties of the CE-complex which we are going to use in the next sections.

First, we give some results about the adjoint action of \mathfrak{g} on its homology.

10.1.7 Proposition. *The adjoint action of \mathfrak{g} on $V \otimes \Lambda \mathfrak{g}$ given by*

$$[v \otimes g_1 \wedge \dots \wedge g_n, g] := [v, g] \otimes g_1 \wedge \dots \wedge g_n \\ + \sum_{i=1}^n v \otimes g_1 \wedge \dots \wedge [g_i, g] \wedge \dots \wedge g_n$$

is compatible with d . The induced action on $H_(\mathfrak{g}, V)$ is trivial.*

Proof. The compatibility with d is formula (10.6.3.0) proved in Lemma 10.6.3 below.

For any $y \in \mathfrak{g}$ let $\sigma(y)$ be the map of degree one given by

$$\sigma(y)(\alpha) = (-1)^{n-1} \alpha \wedge y, \quad \alpha \in V \otimes \Lambda^n \mathfrak{g}.$$

The following identity holds among endomorphisms of $V \otimes \Lambda \mathfrak{g}$ (cf. 10.6.3.1),

$$d\sigma(y) + \sigma(y)d = [-, y].$$

This proves that $\sigma(y)$ is a homotopy from $[-, y]$ to 0, whence the assertion. □

10.1.8 Proposition. *Let \mathfrak{g} be a Lie algebra and V a \mathfrak{g} -module. Let \mathfrak{h} be a reductive sub-Lie algebra of \mathfrak{g} . Then the surjective map $(V \otimes \Lambda^n \mathfrak{g}) \rightarrow (V \otimes \Lambda^n \mathfrak{g})_{\mathfrak{h}}$ induces an isomorphism on homology,*

$$H_*(\mathfrak{g}, V) \cong H_*((V \otimes \Lambda^n \mathfrak{g})_{\mathfrak{h}}, d).$$

Proof. Since \mathfrak{g} and V are completely reducible \mathfrak{h} -modules, the module $V \otimes \Lambda^n \mathfrak{g}$ splits, as a representation of \mathfrak{h} , into a direct sum of all the isotypic components. The component corresponding to the trivial representation is $(V \otimes \Lambda^n \mathfrak{g})_{\mathfrak{h}}$ (coinvariant module). Let us denote by L_n the sum of the other components.

Since \mathfrak{h} is a sub-Lie algebra of \mathfrak{g} , Proposition 10.1.7 implies that d is compatible with the action of \mathfrak{h} . So there is a direct sum decomposition of complexes,

$$V \otimes \Lambda^* \mathfrak{g} \cong (V \otimes \Lambda^* \mathfrak{g})_{\mathfrak{h}} \oplus L_*.$$

In order to prove the proposition, it suffices to show that L_* is an acyclic complex.

Since L_* is made of simple modules which are not trivial as \mathfrak{h} -modules, the components of $H_*(L_*)$ are not trivial either. But, by Proposition 10.1.7, $H_*(\mathfrak{g}, V)$ is a trivial \mathfrak{g} -module and so, a trivial \mathfrak{h} -module. Therefore $H_*(L_*)$ has to be zero. □

Exercises

E.10.1.1. $H^2(\mathfrak{g}, V)$ and Extensions. For fixed \mathfrak{g} and V consider the extensions (\mathfrak{h}) of Lie algebras of the form

$$0 \rightarrow V \rightarrow \mathfrak{h} \rightarrow \mathfrak{g} \rightarrow 0$$

for which the Lie bracket on V (induced by the Lie bracket of \mathfrak{h}) is trivial and the induced action of \mathfrak{g} on V is the prescribed one. Two such extensions (\mathfrak{h}) and (\mathfrak{h}') are isomorphic when there exists a Lie algebra map from \mathfrak{h} to \mathfrak{h}' which is compatible with the identity on V and the identity on \mathfrak{g} . Let $\text{Ext}(\mathfrak{g}, V)$ be the set of isomorphism classes of extensions of \mathfrak{g} by V . Show that there is a canonical bijection

$$\text{Ext}(\mathfrak{g}, V) \cong H^2(\mathfrak{g}, V).$$

(Cf. Cartan-Eilenberg [CE].)

E.10.1.2. Universal Central Extensions. With the notation of the preceding exercise an extension of \mathfrak{g} is called *central* if V is central in \mathfrak{h} , that is $[V, \mathfrak{h}] = 0$. A central extension $\mathfrak{u} \rightarrow \mathfrak{g}$ is called *universal* if for any other central extension $\mathfrak{h} \rightarrow \mathfrak{g}$ there is a unique map from \mathfrak{u} to \mathfrak{h} over \mathfrak{g} . Show that \mathfrak{g} has a universal central extension iff \mathfrak{g} is perfect ($\mathfrak{g} = [\mathfrak{g}, \mathfrak{g}]$). Show that the kernel of this central extension is $H_2(\mathfrak{g})$ and its class in $H^2(\mathfrak{g}, H_2(\mathfrak{g})) \cong \text{Hom}(H_2(\mathfrak{g}), H_2(\mathfrak{g}))$ corresponds to the identity (compare with 11.1.11).

E.10.1.3. $H^3(\mathfrak{g}, V)$ and Crossed Modules. A *crossed module of Lie algebras* is a Lie algebra homomorphism $\mu : \mathfrak{m} \rightarrow \mathfrak{n}$ together with a \mathfrak{n} -module structure η of \mathfrak{m} satisfying the following relations:

- (a) $\mu(\eta(n).m) = [n, \mu(m)]$ for all $n \in \mathfrak{n}$ and all $m \in \mathfrak{m}$,
- (b) $\eta(\mu(m)).m' = [m, m']$ for all $m, m' \in \mathfrak{m}$.

Show that $V = \text{Ker } \mu$ is an abelian Lie algebra and that the action of \mathfrak{n} on \mathfrak{m} induces a structure of $\mathfrak{g} = \text{Coker } \mu$ -module on V .

For a fixed pair (\mathfrak{g}, V) two crossed modules $\mu : \mathfrak{m} \rightarrow \mathfrak{n}$ and $\mu' : \mathfrak{m}' \rightarrow \mathfrak{n}'$ are said to be *related* if there exists a commutative diagram of Lie algebras

$$\begin{array}{ccc} \mathfrak{m} & \xrightarrow{\mu} & \mathfrak{n} \\ \downarrow & & \downarrow \\ \mathfrak{m}' & \xrightarrow{\mu'} & \mathfrak{n}' \end{array}$$

where the vertical maps are compatible with the actions of \mathfrak{n} on \mathfrak{m} and of \mathfrak{n}' on \mathfrak{m}' . We also require that these vertical maps induce the identity on the horizontal kernel ($= V$) and cokernel ($= \mathfrak{g}$). Let $\mathcal{X}\text{mod}(\mathfrak{g}, V)$ be the set of classes of crossed modules with cokernel \mathfrak{g} and kernel V , modulo the equivalence relation induced by the relation described above. Show that there is a canonical isomorphism

$$\mathcal{X}\text{mod}(\mathfrak{g}, V) \cong H^3(\mathfrak{g}, V).$$

(A variation in a relative case is treated in Kassel-Loday [1982].)

10.2 Homology of the Lie Algebra $gl(A)$

This section contains the main theorem of the chapter, that is the relationship between the homology of the Lie algebra of matrices and cyclic homology. For any Lie algebra the diagonal map induces a coalgebra structure on the homology. Our aim is to compute the primitive part corresponding to this comultiplication for the Lie algebra $gl(A)$ of all finite dimensional matrices. The main result (Theorem 10.2.4) is the following isomorphism,

$$\text{Prim } H_*(gl(A)) \cong HC_{*-1}(A) .$$

In fact $H_*(gl(A))$ is a graded commutative and cocommutative Hopf algebra, therefore it is completely determined by its primitive part,

$$H_*(gl(A)) \cong \Lambda(HC_*(A)[1]) .$$

Since cyclic homology is computable in many cases, this isomorphism makes it possible to compute $H_*(gl(A))$ in a lot of new cases.

Most of this section is taken out from Loday-Quillen [LQ].

Standing Assumptions. The field k is of characteristic zero and A is a unital associative k -algebra unless otherwise stated.

10.2.1 The Lie Algebra of Matrices, Notation. The associative algebra of $r \times r$ matrices with entries in A is denoted $\mathcal{M}_r(A)$. Equipped with the Lie bracket $[\alpha, \beta] = \alpha\beta - \beta\alpha$ it becomes a Lie algebra denoted $gl_r(A)$ (*general linear Lie algebra*). The inclusion $\mathcal{M}_r(A) \rightarrow \mathcal{M}_{r+1}(A)$ given by

$$\alpha \mapsto \begin{bmatrix} & & & & 0 \\ & & & & \cdot \\ & & \alpha & & \cdot \\ & & & & 0 \\ 0 & \cdot & \cdot & 0 & 0 \end{bmatrix}$$

induces an inclusion of Lie algebras $\text{inc} : gl_r(A) \rightarrow gl_{r+1}(A)$. The inductive limit is denoted $gl_\infty(A)$ or, more often, $gl(A)$. As before the elementary matrix whose only nonzero entry is at the (i, j) -position is denoted E_{ij}^a . The Lie algebra $gl_r(k)$ is abbreviated as gl_r , and the group $GL_r(k)$ is abbreviated as GL_r .

The trace map $\text{Tr} : gl_r(A) \rightarrow A/[A, A]$, $\text{Tr}(\alpha) = \sum_i \alpha_{ii}$ is a homomorphism of Lie algebras and its kernel is a Lie algebra denoted $sl_r(A)$ (*special linear Lie algebra*). It is obvious that $gl_r(A)$ is generated as a k -module by the elementary matrices E_{ij}^a $a \in A$, $1 \leq i, j \leq r$. As a sub-Lie algebra of $gl_r(A)$, $sl_r(A)$ is generated by the elementary matrices E_{ij}^a with the restriction $i \neq j$ or, if $i = j$, $a \in [A, A]$. Then it is easy to check that

$$H_1(gl_r(A)) = gl_r(A)_{ab} \cong gl_r(A)/sl_r(A) \cong A/[A, A] .$$

10.2.2 Stabilization. In this section we are interested in the homology groups $H_n(gl_r(A))$ for r large with respect to n . In fact homology commutes with direct limit and so

$$H_n(gl(A)) \cong \lim_r H_n(gl_r(A)) .$$

How large r needs to be so that $H_n(gl_r(A))$ is actually isomorphic to $H_n(gl(A))$ will be dealt with in the next section (Theorem 10.3.2).

Since the module of coefficients is the trivial module k , the CE-complex that we have to look at takes the following form:

$$\dots \rightarrow \Lambda^n gl_r(A) \xrightarrow{d} \Lambda^{n-1} gl_r(A) \rightarrow \dots \rightarrow \Lambda^1 gl_r(A) \rightarrow \Lambda^0 gl_r(A) = k,$$

where

$$\begin{aligned} & d(\alpha_1 \wedge \dots \wedge \alpha_n) \\ &= \sum_{1 \leq i < j \leq n} (-1)^{i+j-1} [\alpha_i, \alpha_j] \wedge \alpha_1 \wedge \dots \wedge \widehat{\alpha}_i \wedge \dots \wedge \widehat{\alpha}_j \wedge \dots \wedge \alpha_n. \end{aligned}$$

10.2.3 From $H_*(gl(A))$ to $HC_*(A)$. Recall from 2.1.4 that for a k -algebra R the module $C_n^\lambda(R)$ is the quotient of the tensor product $R^{\otimes n+1}$ by the submodule generated by the image of $(1 - t)$, where t is the cyclic operator

$$t(a_0, \dots, a_n) = (-1)^n (a_n, a_0, \dots, a_{n-1}), \quad a_i \in R.$$

Let us define for any associative k -algebra A a map

$$\theta : \Lambda^{n+1} gl_r(A) \rightarrow C_n^\lambda(\mathcal{M}_r(A))$$

by the following formula

$$(10.2.3.1) \quad \theta(\alpha_0 \wedge \dots \wedge \alpha_n) = \sum_{\sigma \in S_n} \text{sgn}(\sigma) (\alpha_0, \alpha_{\sigma(1)}, \dots, \alpha_{\sigma(n)}).$$

Here the symmetric group acts on the set of indices $\{1, \dots, n\}$. The map θ is well-defined because on the right hand side we are working modulo the image of $(1 - t)$. In the course of the proof of the next theorem it will be shown that θ commutes with the boundary maps d (on the left) and b (on the right) so that

$$\theta_* : H_{n+1}(gl_r(A)) \rightarrow H_n^\lambda(\mathcal{M}_r(A))$$

is well-defined (this commutation can be verified directly). Then the composition with the generalized trace map $\text{tr}_* : H_n^\lambda(\mathcal{M}_r(A)) \rightarrow H_n^\lambda(A)$ (cf. 2.2.10) and with the isomorphism $H_n^\lambda(A) \cong HC_n(A)$ (we are in characteristic zero, cf. 2.1.5) gives the map

$$\text{tr}_* \circ \theta_* : H_*(gl_r(A)) \rightarrow HC_{*-1}(A).$$

It is clear from the construction that this map passes to the limit and is well-defined for $r = \infty$.

Recall from 10.1.5 that $H_*(gl(A))$ is a coalgebra with comultiplication Δ induced by the diagonal map. Its primitive part is $\text{Prim } H_*(gl(A)) = \{x \in H_*(gl(A)) \mid \Delta(x) = x \otimes 1 + 1 \otimes x\}$ (cf. Appendix A).

10.2.4 Theorem. *Let k be a characteristic zero field and let A be a unital associative k -algebra. The restriction of $\text{tr}_* \circ \theta_*$ to the primitive part of $H_*(gl(A))$ induces an isomorphism*

$$\text{tr}_* \circ \theta_* : \text{Prim } H_*(gl(A)) \xrightarrow{\sim} HC_{*-1}(A).$$

Remark. By analogy with the general linear group case (cf. 11.2.12) the primitive part of $H_*(gl(A))$ is sometimes called “additive K -theory” and denoted $K_*^+(A)$ (cf. introduction of 4.4). Hence Theorem 10.2.4 can be read as $K_n^+(A) \cong HC_{n-1}(A)$ for $n \geq 1$.

10.2.5 Theorem. *With the same hypothesis as above, there is a canonical isomorphism of graded Hopf algebras*

$$H_*(gl(A)) \cong \Lambda(HC_*(A)[1]).$$

We first give a sketch of the proof of these two theorems and their translation into the cohomological framework.

10.2.6 Sketch of the Proof of 10.2.4 and 10.2.5. The proof of 10.2.4 is divided into 4 steps.

Firstly, we perform a sort of Quillen’s plus-construction in the Lie algebra framework. It consists essentially in factoring out the CE-complex by the action of gl to get a smaller, though quasi-isomorphic, complex.

Secondly, we apply the invariant theory to simplify greatly this new complex so that no matrices are involved anymore.

Thirdly, we show that factoring out by the action of gl has a second advantage: the new complex is a differential graded cocommutative Hopf algebra.

Finally, we are able to identify the primitive part of this Hopf algebra which turns out to be Connes complex.

To prove Corollary 10.2.5 it suffices to show that the GH-algebra $H_*(gl(A))$ is not only cocommutative but also commutative, and to apply the Cartan-Milnor-Moore theorem.

The proof is performed in such a way that steps 1 and 2 give information on the homology of $gl_r(A)$ for fixed r (see Sects. 10.3 and 10.6).

10.2.7 Theorem. *Let k be a characteristic zero field and let A be a unital associative k -algebra. The image of the map $\theta^* \circ \text{tr}^*$ lies in the indecomposable part of $H^*(gl(A))$ and induces an isomorphism (dual to 10.2.4),*

$$\theta^* \circ \text{tr}^* : HC^{*-1}(A) \xrightarrow{\sim} \text{Indec } H^*(gl(A)).$$

10.2.8 Corollary. *With the same hypothesis as above there is a canonical isomorphism of graded Hopf algebras*

$$\Lambda(HC^*(A)[1]) \cong H^*(gl(A)).$$

10.2.9 Proof of Theorem 10.2.4, First Step: Reductivity of gl_r .

For any finite integer r (excluding $r = \infty$) the Lie algebra $gl_r := gl_r(k)$ is reductive. Since we assume A to be unital, gl_r is embedded into $gl_r A := gl_r(A)$, and so we can apply Proposition 10.1.8 to $\mathfrak{g} = gl_r A$, $\mathfrak{h} = gl_r$ and $V = k$ to get a quasi-isomorphism of complexes

$$(\Lambda^* gl_r A, d) \rightarrow ((\Lambda^* gl_r A)_{gl_r}, d).$$

10.2.10 Second Step: Application of Invariant Theory. Our aim is to show that the following sequence, in which $I_{n,r}$ is the submodule of $k[S_n]$ described in 9.2.6, is a sequence of isomorphisms,

(10.2.10.1)

$$\begin{aligned} (\Lambda^n gl_r A)_{gl_r} &\stackrel{1}{\cong} \left(\left((gl_r A)^{\otimes n} \right)_{S_n} \right)_{gl_r} \stackrel{2}{\cong} \left(\left((gl_r A)^{\otimes n} \right)_{gl_r} \right)_{S_n} \\ &\stackrel{3}{\cong} \left((gl_r^{\otimes n} \otimes A^{\otimes n})_{gl_r} \right)_{S_n} \stackrel{4}{\cong} \left((gl_r^{\otimes n})_{gl_r} \otimes A^{\otimes n} \right)_{S_n} \stackrel{5}{\cong} (I_{n,r} \otimes A^{\otimes n})_{S_n}. \end{aligned}$$

Isomorphism 1. For any k -module M the exterior power $\Lambda^n M$ is simply the coinvariant space $(M^{\otimes n})_{S_n}$ where S_n acts by permutation of the variables and multiplication by the sign.

Isomorphism 2. The gl_r -action on $gl_r(A)^{\otimes n}$ is the adjoint action (see 10.1.1.2) and obviously commutes with the action of the symmetric group.

Isomorphism 3. There is a canonical isomorphism $gl_r A \cong gl_r \otimes A$ whence an isomorphism $(gl_r A)^{\otimes n} \cong gl_r^{\otimes n} \otimes A^{\otimes n}$.

Isomorphism 4. Via the above isomorphism the action of gl_r on $(gl_r A)^{\otimes n}$ corresponds to the adjoint action on $gl_r^{\otimes n}$ and the trivial action on $A^{\otimes n}$.

Isomorphism 5. Here we apply Theorem 9.2.7 of invariant theory. So this isomorphism is $T^* \otimes id_{A^n}$. Note that, in the last module, there are no matrices anymore. Note also that the action of S_n on $I_{n,r} \subset k[S_n]$ comes from the adjoint action of S_n , and the action of S_n on $A^{\otimes n}$ is by permutation of factors and multiplication by the sign.

The composite of these 5 isomorphisms is denoted by Θ .

Corollary 9.2.8 of invariant theory tells us that, for $r \geq n$, one has $I_{n,r} = k[S_n]$. As a consequence we get at the limit a canonical isomorphism of modules

$$(10.2.10.2) \quad \Theta : (\Lambda^n gl(A))_{gl} \cong (k[S_n] \otimes A^{\otimes n})_{S_n}.$$

The next lemma describes explicitly the values of Θ on certain specific elements.

10.2.11 Lemma. For any permutation σ in S_n one has

$$\Theta \left(E_{1\sigma(1)}^{a_1} \wedge E_{2\sigma(2)}^{a_2} \wedge \dots \wedge E_{n\sigma(n)}^{a_n} \right) = (\sigma \otimes (a_1, \dots, a_n)) \in (k[S_n] \otimes A^{\otimes n})_{S_n}.$$

Proof. By the first four isomorphisms of (10.2.10.1) the exterior product of elementary matrices becomes

$$(E_{1\sigma(1)}, E_{2\sigma(2)}, \dots, E_{n\sigma(n)}) \otimes (a_1, \dots, a_n) \in \left((gl_n^{\otimes n})_{gl_n} \otimes A^{\otimes n} \right)_{S_n}.$$

So we only need to check that $T^*(E_{1\sigma(1)}, E_{2\sigma(2)}, \dots, E_{n\sigma(n)}) = \sigma$, which is precisely Lemma 9.2.10. \square

10.2.12 Third Step: Hopf Algebra Properties. The aim of this subsection is to show that the coinvariant CE-complex $(\Lambda^* gl(A)_{gl}, d)$ is a differential graded Hopf (DGH)-algebra, which is cocommutative and commutative.

The diagonal map $\Delta : gl(A) \rightarrow gl(A) \times gl(A)$ is a Lie algebra map and so it induces a map of complexes $\Lambda^* gl(A)_{gl} \rightarrow \Lambda^*(gl(A) \times gl(A))_{gl}$. Since k is a characteristic zero field, there is a canonical isomorphism $\Lambda^*(gl(A) \times gl(A))_{gl} \cong \Lambda^* gl(A)_{gl} \otimes \Lambda^* gl(A)_{gl}$ whose composite with the diagonal map gives the comultiplication. It is immediate to check that this comultiplication is coassociative and cocommutative.

In order to define the multiplication map we consider the direct sum of matrices

$$\oplus : gl(A) \times gl(A) \rightarrow gl(A)$$

given by

$$\alpha = \begin{bmatrix} * & * & * & | & & \\ * & * & * & | & & \\ * & * & * & | & & \\ \hline & & & & & \end{bmatrix} \qquad \beta = \begin{bmatrix} \times & \times & \times & | & & \\ \times & \times & \times & | & & \\ \times & \times & \times & | & & \\ \hline & & & & & \end{bmatrix}$$

$$\alpha \oplus \beta = \begin{bmatrix} * & 0 & * & 0 & * & 0 & | & & \\ 0 & \times & 0 & \times & 0 & \times & | & & \\ * & 0 & * & 0 & * & 0 & | & & \\ 0 & \times & 0 & \times & 0 & \times & | & & \\ * & 0 & * & 0 & * & 0 & | & & \\ 0 & \times & 0 & \times & 0 & \times & | & & \\ \hline & & & & & & & & \end{bmatrix}$$

This is a Lie algebra map which extends to a map of complexes $\Lambda^* gl(A) \otimes \Lambda^* gl(A) \rightarrow \Lambda^* gl(A)$. This product is neither associative nor commutative because $(\alpha \oplus \beta) \oplus \gamma$ is only conjugate (by a permutation matrix) to $\alpha \oplus (\beta \oplus \gamma)$,

but not equal, and similarly for $\alpha \oplus \beta$ and $\beta \oplus \alpha$. However, upon passing to the coinvariants we get an associative and commutative product

$$\oplus_* : \Lambda^* gl(A)_{gl} \otimes \Lambda^* gl(A)_{gl} \rightarrow \Lambda^* gl(A)_{gl} .$$

Here we can either use the fact that $\Lambda^* gl(A)_{gl} = \Lambda^* gl(A)_{GL}$ (cf. 9.2.5) and that the permutation matrices belong to $GL = GL(k) \subset GL(A)$, or use Proposition 10.1.7 (cf. Exercise E.10.2.4).

Since the comultiplication is induced by a Lie algebra map, the multiplication and comultiplication of $\Lambda^* gl(A)_{gl}$ commute. So we have proved the following

10.2.13 Proposition. *$((\Lambda^* gl(A))_{gl}, d)$ is a commutative and cocommutative DGH-algebra.* □

Remark. If we were only interested in the Hopf algebra structure, it would have been sufficient to factor out by the action of the subgroup of permutation matrices.

10.2.14 Corollary. *$H_*(gl(A))$ is a commutative and cocommutative GH-algebra whose primitive part is the homology of $\text{Prim}(\Lambda^* gl(A))_{gl}$.*

Proof. Cf. Appendix A.9. □

10.2.15 Fourth Step: Computation of the Primitive Part. Let $U_n \subset S_n$ be the conjugacy class of the cycle $\tau := (1\ 2\ \dots\ n)$. The space $P_* := \oplus_{n \geq 1} (k[U_n] \otimes A^{\otimes n})_{S_n}$ is a subspace of $L_* := \oplus_{n \geq 0} (k[S_n] \otimes A^{\otimes n})_{S_n}$. There is a coalgebra structure on L_* given by

$$\Delta(\sigma \otimes (a_1, \dots, a_n)) = \sum_{I, J} (\sigma_I \otimes (\dots, a_i, \dots)) \otimes (\sigma_J \otimes (\dots, a_j, \dots)),$$

where the sum is extended over all ordered partitions (I, J) of $\{1, \dots, n\}$ such that $\sigma(I) = I$ and $\sigma(J) = J$. In this formula σ_I (resp. σ_J) denotes the restriction of σ to the ordered set I (resp. J), and i is in I (resp. j is in J).

By construction the space P_* is a subspace of $\text{Prim } L_*$. The next proposition shows that, via Θ , L_* is a connected Hopf algebra which is commutative and cocommutative. Hence by the Cartan-Milnor-Moore theorem there is an isomorphism $\Lambda \text{Prim } L_* \cong L_*$. Since any permutation is a product of cycles, the map $\Lambda P_* \rightarrow \Lambda \text{Prim } L_*$, which is injective, is also surjective. Therefore it is an isomorphism and $P_* = \text{Prim } L_*$.

10.2.16 Proposition. *The coalgebra map Δ' on L_* induced by the isomorphism $\Theta : \Lambda^* gl(A)_{gl} \cong L_*$ from the coalgebra structure of $\Lambda^* gl(A)_{gl}$ is the map Δ described above.*

Proof. Let $\sigma \in S_n$ and put $\alpha_i = E_{i\sigma(i)}^{a_i}$. Since $\Theta(\alpha_1, \dots, \alpha_n) = \sigma \otimes (a_1, \dots, a_n)$ our aim is to compute $\sum \Theta(\alpha_{i_1}, \dots, \alpha_{i_p}) \otimes \Theta(\alpha_{i_{p+1}}, \dots, \alpha_{i_{p+q}})$ where the sum is extended over all (p, q) -shuffles (i_1, \dots, i_{p+q}) . The element $\Theta(\alpha_{i_1}, \dots, \alpha_{i_p})$ is nonzero iff $\sigma(i_1) = i_2, \sigma(i_2) = i_3, \dots, \sigma(i_p) = i_1$. In this case $I = \{i_1, \dots, i_p\}$ is stable by σ and $\Theta(\alpha_{i_1}, \dots, \alpha_{i_p}) = \sigma_I \otimes (\dots, a_{i_j}, \dots)$. Therefore we have proved the following equality

$$\begin{aligned} &\Delta'(\sigma \otimes (a_1, \dots, a_n)) \\ &= \Theta \circ \Delta(\alpha_1, \dots, \alpha_n) = \sum \Theta(\alpha_{i_1}, \dots, \alpha_{i_p}) \otimes \Theta(\alpha_{i_{p+1}}, \dots, \alpha_{i_{p+q}}) \\ &= \sum_{I, J} (\sigma_I \otimes (\dots, a_i, \dots)) \otimes (\sigma_J \otimes (\dots, a_j, \dots)) = \Delta(\sigma \otimes (a_1, \dots, a_n)). \quad \square \end{aligned}$$

10.2.17 Corollary. *There is a sequence of isomorphisms*

$$\begin{aligned} \text{Prim}(A^*gl(A))_{gl} &\cong \bigoplus_{n \geq 1} (k[U_n] \otimes A^{\otimes n})_{S_n} \cong \bigoplus_{n \geq 1} (A^{\otimes n})_{\mathbb{Z}/n\mathbb{Z}} \\ &= \bigoplus_{n \geq 1} A^{\otimes n} / (1 - t) = C_{*-1}^\lambda(A). \end{aligned}$$

Proof. The primitive part is completely determined by the comultiplication map. By (10.2.10.2) and Proposition 10.2.16 the map Θ is an isomorphism of coalgebras, therefore Θ induces the first isomorphism.

The map $U_n \rightarrow S_n / (\mathbb{Z}/n\mathbb{Z}), \omega \tau \omega^{-1} \mapsto \text{class of } \omega$, is a bijection of S_n -sets. Here $\mathbb{Z}/n\mathbb{Z}$ is embedded in S_n by sending 1 to τ . So the S_n -module $k[U_n]$ is isomorphic to the module induced from the trivial $\mathbb{Z}/n\mathbb{Z}$ -module k by the inclusion $\mathbb{Z}/n\mathbb{Z} \hookrightarrow S_n$. This gives the second isomorphism:

$$\begin{aligned} (k[U_n] \otimes A^{\otimes n})_{S_n} &\cong k \otimes_{k[S_n]} k[S_n / (\mathbb{Z}/n\mathbb{Z})] \otimes A^{\otimes n} \\ &\cong k \otimes_{k[\mathbb{Z}/n\mathbb{Z}]} (k \otimes A^{\otimes n}) = (A^{\otimes n})_{\mathbb{Z}/n\mathbb{Z}}. \end{aligned}$$

In order to make explicit the action of $\mathbb{Z}/n\mathbb{Z}$ on $A^{\otimes n}$ we have to remember that S_n acts on $A^{\otimes n}$ by permuting the factors and multiplication by the sign. So the generator of $\mathbb{Z}/n\mathbb{Z}$ acts on $A^{\otimes n}$ by cyclic permutation (action of τ) and multiplication by $\text{sgn}(\tau) = (-1)^{n-1}$. This is precisely the action of t (cf. 2.1.0). Whence the equalities

$$(A^{\otimes n})_{\mathbb{Z}/n\mathbb{Z}} = A^{\otimes n} / (1 - t) = C_{n-1}^\lambda(A). \quad \square$$

In order to finish the proof of the main theorem it remains to identify the boundary map from $C_{n-1}^\lambda(A)$ to $C_{n-2}^\lambda(A)$ deduced from the boundary map in the CE-complex.

10.2.18 Proposition. *The isomorphism $\Theta : \text{Prim}(A^*gl(A))_{gl} \cong C_{*-1}^\lambda(A)$ transforms the boundary map d into the Hochschild boundary map b .*

Proof. By Lemma 10.2.11 the image of the element $x = E_{12}^{a_1} \wedge E_{23}^{a_2} \wedge \dots \wedge E_{n1}^{a_n} \in \Lambda^n gl(A)_{gl}$ under Θ is the class of $(\tau \otimes (a_1, \dots, a_n))$. So this element is primitive and represents the class of $(a_1, \dots, a_n) \in C_{n-1}^\lambda(A)$.

On the other hand one has the equality

$$(10.2.18.1) \quad d(x) = \sum_{i=1}^n (-1)^{i+1} E_{12}^{a_1} \wedge \dots \wedge E_{i \ i+2}^{a_i a_{i+1}} \wedge \dots \wedge E_{n1}^{a_n}$$

(where the index $n + 1$ is replaced by 1 when appearing) in the CE-complex since $E_{ij}^a E_{kl}^b = 0$ if $j \neq k$ and $= E_{il}^{ab}$ if $j = k$ (use formula (10.1.3.3) with $g_0 = 1$). Its image in $C_{n-2}^\lambda(A)$ is

$$\begin{aligned} \sum_{i=1}^{n-1} (-1)^{i+1} (a_1, \dots, a_i a_{i+1}, \dots, a_n) + (-1)^{n-1} (a_n a_1, a_2, \dots, a_{n-1}) \\ = b(a_1, a_2, \dots, a_n), \end{aligned}$$

for the same reason as before. So we have proved that $\Theta \circ d = b \circ \Theta$. □

10.2.19 End of the Proof of Theorem 10.2.4. Summarizing the previous steps we get the following sequence of isomorphisms

$$\begin{aligned} \text{Prim } H_*(gl(A)) &\cong \text{Prim } H_*(gl(A)_{gl}) \cong H_*(\text{Prim } (\Lambda^* gl(A))_{gl}) \\ &\cong H_*(C_{*-1}^\lambda(A), b) \cong HC_{*-1}(A), \end{aligned}$$

where the last one was proved in 2.1.5.

It remains to check that this isomorphism is precisely $\text{tr}_* \circ \theta_*$. It is sufficient to check that

$$\text{tr}_* \circ \theta_* (E_{12}^{a_1} \wedge E_{23}^{a_2} \wedge \dots \wedge E_{n1}^{a_n}) = (a_1, \dots, a_n) \in C_{n-1}^\lambda(A),$$

which follows from (10.2.3.1) and the identities among the elementary matrices. □

10.2.20 Proof of Theorem 10.2.5. By Corollary 10.2.14 $H_*(gl(A))$ is a commutative and cocommutative GH-algebra, therefore it is isomorphic to the symmetric graded algebra over its primitive part by the Cartan-Milnor-Moore theorem (cf. Appendix A.10). Since by Theorem 10.2.4 there is a graded isomorphism

$$\text{Prim } H_*(gl(A)) \cong HC_*(A)[1],$$

we have proved the theorem. □

Exercises

E.10.2.1. Show that under the standing assumption

$$H_*(sl(A)) \cong \Lambda \left(\left(\bigoplus_{n \geq 1} HC_n(A) \right) [1] \right).$$

E.10.2.2. Show that the tensor product of matrices can be used to define a graded operation on $H_*(gl(A))$ whose restriction to the primitive part coincides with the product (cf. 4.4.5) on cyclic homology (cf. P. Gaucher [1991a]).

E.10.2.3. Show that the exterior product of matrices can be used to define λ -operations on $H_*(gl(A))$ whose restrictions to the primitive part coincide with the λ -operations (cf. Sect. 4.6) on cyclic homology (cf. Loday-Procesi [1989] and Gaucher [1991b]).

E.10.2.4. Let the invertible matrix $g \in GL_r(A)$ act on $\Lambda^n gl_r(A)$ by

$$g \cdot (g_1, \dots, g_n) = (gg_1g^{-1}, \dots, gg_ng^{-1}).$$

Show that this action is compatible with d and that the induced action on $H_*(gl_r(A))$ is trivial (A is supposed to be unital). [One can either use Proposition 10.1.7, or Theorem 3.3.2 and Proposition 6.1.2.]

E.10.2.5. Let $st_n(A)$ be the Lie algebra generated over k by the elements $u_{ij}(a)$, $a \in A$, $1 \leq i \neq j \leq n$ (we suppose that $n \geq 3$), with the relations

(a) $u_{ij}(\lambda a + \mu b) = \lambda u_{ij}(a) + \mu u_{ij}(b)$ for $a, b \in A$ and $\lambda, \mu \in k$,

(b) $[u_{ij}(a), u_{kl}(b)] = \begin{cases} 0 & \text{if } i \neq l \text{ and } j \neq k, \\ u_{il}(ab) & \text{if } i \neq l \text{ and } j = k. \end{cases}$

Show that for $n \geq 3$ $\phi : st_n(A) \rightarrow sl_n(A)$, $\phi(u_{ij}(A)) = E_{ij}(A)$, is a universal central extension and that $\text{Ker } \phi \cong HC_1(A)$. Deduce from these results that $H_2(sl_n(A)) \cong HC_1(A)$ and $H_3(st(A)) \cong HC_2(A)$ (see Exercise E.10.1.2). Show that this result is coherent with Theorems 10.2.5 and 10.3.2 (cf. Bloch [1981] and Kassel-Loday [1982] in which there is also a relative version).

E.10.2.6. Extend the isomorphism $H_*(gl(A)) \cong \Lambda(HC_*(A)[1])$ to H -unital algebras A (cf. P. Hanlon [1988]).

10.3 Stability and First Obstruction to Stability

In the previous section we remarked that the homology group $H_n(gl_r(A))$ does not depend on the size of matrices provided that it is large enough. Here, we make this remark more precise by showing that the bound is $r \geq n$. Moreover we are able to compute the first obstruction to stability. In the commutative case it is the module $\Omega_{A|k}^n / d\Omega_{A|k}^{n-1}$, which happens to be the direct summand of cyclic homology generated by $HC_0(A)$ under the product. So this result is analogous to a theorem of Suslin which claims that the first

obstruction to stability, for the homology of the general linear group, is Milnor K -theory (cf. 11.2.17).

A conjecture about the computation of $H_*(gl_r(A))$, when A is commutative, is proposed in 10.3.9.

Standing Assumptions. The field k is of characteristic zero and A is a unital associative k -algebra unless otherwise stated.

10.3.1 Homology of $gl_r(A)$, Notation. In order to compute the homology of the Lie algebra $gl_r(A)$, for fixed r , we can apply the first two steps of the $gl(A)$ -case, that is

- take the coinvariants by $gl_r(k)$ in the CE-complex,
- apply invariant theory.

But then life becomes more complicated, since there is no reason a priori for the coalgebra $H_*(gl_r(A))$ to be a Hopf algebra. The point is that $gl_r(A)$ is not closed under the direct sum of matrices. However one can try to compute directly the complex so obtained by exploiting information coming from invariant theory. This permits us to prove the following

10.3.2 Theorem (Stability for the Homology of $gl_r(A)$). *Let k be a characteristic zero field and let A be a unital associative k -algebra. For any integer $n \geq 1$ the stabilization maps induce isomorphisms*

$$H_n(gl_n(A)) \xrightarrow{\sim} H_n(gl_{n+1}(A)) \xrightarrow{\sim} \dots \xrightarrow{\sim} H_n(gl(A)) .$$

The proof will be performed in 10.3.5.

10.3.3 A Milnor Type Cyclic Homology Group. In order to describe the obstruction to stability in the non-commutative case we need to introduce the following group. By definition $HC_{n-1}^M(A)$ is the quotient of $\Lambda^n A$ (taken over k) by the relations

$$(10.3.3.1) \quad (a_0 a_1 - a_1 a_0) \wedge a_2 \wedge \dots \wedge a_n = 0 ,$$

$$(10.3.3.2) \quad (a_0 a_1 \wedge a_2 - a_0 \wedge a_1 a_2 + a_2 a_0 \wedge a_1) \wedge a_3 \wedge \dots \wedge a_n = 0 ,$$

for all $a_0, \dots, a_n \in A$.

If A is commutative, then condition (10.3.3.1) is automatically fulfilled and the map

$$HC_{n-1}^M(A) \rightarrow \Omega_{A|k}^{n-1} / d\Omega_{A|k}^{n-2}, \quad a_1 \wedge a_2 \wedge \dots \wedge a_n \mapsto a_1 da_2 \dots da_n$$

induces an isomorphism. Indeed it suffices to verify that this map is well-defined, as well as the inverse map $a_1 da_2 \dots da_n \mapsto a_1 \wedge a_2 \wedge \dots \wedge a_n$.

The group $HC_{n-1}^M(A)$ is called *Milnor cyclic homology group*, since it is analogous to the Milnor K -group in algebraic K -theory (cf. 11.1.16).

10.3.4. Theorem (First Obstruction to Stability). *Let k be a characteristic zero field and let A be a unital associative k -algebra. For all $n \geq 1$ there is an exact sequence*

$$H_n(gl_{n-1}(A)) \rightarrow H_n(gl_n(A)) \rightarrow HC_{n-1}^M(A) \rightarrow 0,$$

which takes the form

$$H_n(gl_{n-1}(A)) \rightarrow H_n(gl_n(A)) \rightarrow \Omega_{A|k}^{n-1}/d\Omega_{A|k}^{n-2} \rightarrow 0,$$

when A is commutative.

10.3.5 Proof of Theorems 10.3.2 and 10.3.4. Let us denote by $L_n(r) := (I_{n,r} \otimes A^{\otimes n})_{S_n}$ the module isomorphic to $(\Lambda^n gl_r A)_{gl_r}$ by the sequence of isomorphisms (10.2.10.1). From steps 1 and 2 of the proof of Theorem 10.2.4 we know that

$$H_*(gl_r(A)) \cong H_*(L_*(r), d).$$

We first prove that the following is a short exact sequence of (horizontal) complexes

(10.3.5.1)

$$\begin{array}{ccccccc} \dots \rightarrow & L_{n+1}(n-1) & \longrightarrow & L_n(n-1) & \rightarrow & L_{n-1}(n-1) & \rightarrow \dots \\ & \downarrow & & \downarrow & & \downarrow & \\ \dots \rightarrow & L_{n+1}(n) & \xrightarrow{d} & L_n(n) & \rightarrow & L_{n-1}(n) & \rightarrow \dots \\ & \downarrow & & \downarrow \pi & & \downarrow & \\ \dots \rightarrow & \cdot & \longrightarrow & \Lambda^n A & \rightarrow & 0 & \rightarrow \dots \end{array}$$

The inclusion of $L_*(n-1)$ into $L_*(n)$ is induced by the inclusion of $I_{*,n-1}$ into $I_{*,n}$. Therefore the cokernel complex is $((I_{m,n}/I_{m,n-1}) \otimes A^{\otimes m})_{S_m}$ in degree m . In particular, this module is 0 if $m > n$ and is

$$L_n(n)/L_n(n-1) = ((I_{n,n}/I_{n,n-1}) \otimes A^{\otimes n})_{S_n} \cong (k \otimes A^{\otimes n})_{S_n} = \Lambda^n A$$

for $m = n$ (cf. 9.2.6 and Corollary 9.2.9). Note that the surjective map π is induced by the sign map.

By taking the homology of (10.3.5.1) we get a long exact sequence

(10.3.5.2)

$$\begin{aligned} H_n(gl_{n-1}(A)) \rightarrow H_n(gl_n(A)) &\xrightarrow{\pi_*} \Lambda^n A / \approx \rightarrow H_{n-1}(gl_{n-1}(A)) \\ &\rightarrow H_{n-1}(gl_n(A)) \rightarrow 0 \rightarrow \cdot \xrightarrow{\cong} \cdot \rightarrow \dots \end{aligned}$$

This proves that stability begins at least at $H_{n-2}(gl_{n-1}(A))$ (or equivalently at $H_n(gl_{n+1}(A))$). In order to prove that it really begins at $H_{n-1}(gl_{n-1}(A))$

(or equivalently at $H_n(\mathfrak{gl}_n(A))$), which would finish the proof of Theorem 10.3.2), it suffices to prove that π_* is surjective.

10.3.6 Proposition. *The map π_* is surjective and naturally split.*

Proof. The element $x = E_{11}^{a_1} \wedge E_{22}^{a_2} \wedge \dots \wedge E_{nn}^{a_n} \in \Lambda^n \mathfrak{gl}_n(A)$ is a cycle in the CE-complex since $[E_{ii}^{a_i}, E_{jj}^{a_j}] = 0$ for $i \neq j$. By Lemma 10.2.11 its image in $L_n(n)$ via the sequence of isomorphisms (10.2.10.1) for $r = n$ is the class of $id \otimes (a_1, \dots, a_n)$. Its image under π is $a_1 \wedge \dots \wedge a_n$, and so we have proved that any element in $\Lambda^n A$ is the image under π of a (functorial) cycle in $L_n(n)$. \square

In order to finish the proof of Theorem 10.3.4 it is sufficient to identify the equivalence relation \approx of (10.3.5.2).

10.3.7 Proposition. *There is a canonical isomorphism*

$$HC_{n-1}^M(A) \cong \Lambda^n A / \approx .$$

Proof. Recall that the quotient by the equivalence relation \approx consists in factoring out by the image of $L_{n+1}(n)$ under $\pi \circ d$.

Let us first show that this image is equal to the image of $L_{n+1}(n+1)$ under $\pi \circ d$. From invariant theory (cf. 9.2.9) we know that there is a splitting $k[S_{n+1}] = I_{n+1, n+1} \cong I_{n+1, n} \oplus 1 \cdot k$. In 10.3.6 it is shown that the image of $(1 \cdot k \otimes A^{\otimes n})_{S_n}$ is 0 under d . Replacing n by $n+1$, this shows that $L_{n+1}(\infty) = L_{n+1}(n+1)$ and $L_{n+1}(n)$ have the same image under d .

It remains now to check that the image of the composite

$$L_{n+1}(\infty) \xrightarrow{d} L_n(\infty) \xrightarrow{\pi} \Lambda^n A$$

is generated by the elements appearing in (10.3.3.1) and (10.3.3.2).

Recall from Sect. 10.2 that $L_*(\infty)$ is the exterior algebra of $(C_*^\lambda(A), b)$. So a generator of $L_*(\infty)$ is of the form $x_1 \wedge \dots \wedge x_r$ where $x_i \in C_*^\lambda(A)$, and its value under the differential is

$$d(x_1 \wedge \dots \wedge x_n) = \sum_i \pm x_1 \wedge \dots \wedge b(x_i) \wedge \dots \wedge x_r .$$

So $\Lambda^n A / \approx$ is the quotient of $\Lambda^n A$ by all the relations

$$(10.3.7.1)_k$$

$$\pi \circ b(a_0, \dots, a_k) \wedge a_{k+1} \wedge \dots \wedge a_n = 0 \text{ for } 0 \leq k \leq n \text{ and all } a_i \in A .$$

Recall that

$$(10.3.7.2)$$

$$\begin{aligned} \pi \circ b(a_0, \dots, a_k) = \\ \sum_{i=1}^{k-1} (-1)^i a_0 \wedge \dots \wedge a_i a_{i+1} \wedge \dots \wedge a_k + (-1)^k a_k a_0 \wedge a_1 \wedge \dots \wedge a_{k-1} . \end{aligned}$$

For $k = 0$, $\pi \circ b(a_0) = 0$ and there is no relation.

For $k = 1$, $\pi \circ b(a_0, a_1) = a_0a_1 - a_1a_0$ and relation (10.3.7.1)₁ is precisely relation (10.3.3.1).

For $k = 2$, $\pi \circ b(a_0, a_1, a_2) = a_0a_1 \wedge a_2 - a_0 \wedge a_1a_2 + a_2a_0 \wedge a_1$ and relation (10.3.7.1)₂ is precisely relation (10.3.3.2).

The proof of Theorem 10.3.4 will be completed once we show the following

10.3.8 Lemma. *For $k \geq 3$ the relation (10.3.7.1)_k is a consequence of the cases $k = 1$ and $k = 2$.*

Proof. By induction on k it is sufficient to show that the relation for k is a consequence of the relations for $k - 1, 2$ and 1 .

To simplify the notation let us write i instead of a_i . From formula (10.3.7.2) we get

$$\begin{aligned} & \pi \circ b(0, \dots, k) - \pi \circ b(0, \dots, k - 1) \wedge k \\ &= (-1)^{k-1} 0 \wedge \dots \wedge (k - 2) \wedge (k - 1)k + (-1)^k k0 \wedge 1 \wedge \dots \wedge (k - 1) \\ & \quad - (-1)^{k-1} (k - 1)0 \wedge 1 \wedge \dots \wedge (k - 2) \wedge k, \\ &= ((k - 1)k \wedge 0 - (k - 1) \wedge k0 + (k - 1)0 \wedge k) \wedge 1 \wedge \dots \wedge (k - 2), \\ &= ((k - 1)k \wedge 0 - (k - 1) \wedge k0 + 0(k - 1) \wedge k) \wedge 1 \wedge \dots \wedge (k - 2) \\ & \quad \text{by relation (10.3.7.1)}_1 \\ &= 0 \quad \text{by relation (10.3.7.1)}_2. \quad \square \end{aligned}$$

The last part of this section is devoted to $H_*(gl_r(A))$ for fixed r .

10.3.9 Conjecture. Let A be a commutative and unital algebra over a characteristic zero field k . Then, for any positive integer r , there is a canonical isomorphism

$$H_*(gl_r(A)) \cong \Lambda \left(\bigoplus_{i < r} HC_{*-1}^{(i)}(A) \right),$$

where $HC_* = \bigoplus_i HC_*^{(i)}$ is the λ -decomposition of cyclic homology (cf. 4.6.7).

10.3.10 Comments on the Conjecture. It would be safer to replace the conjecture by a question: for which commutative algebras does this isomorphism hold?

It holds for $A = k$. Indeed, on one hand it has been known for several years that $H_*(gl_r(k))$ is a graded symmetric algebra generated by (primitive) generators in dimensions $1, 3, \dots, 2r - 1$ (cf. Koszul [1958]). Under the isomorphisms of (10.2.10.1) the generator in dimension $2i + 1$ (coming from gl_{i+1}) corresponds to the Amitsur-Levitzki element $AL_i \in I_{2i+1, i}$ (cf. 9.3.8). Its image by Θ is the generator $(-1)^i 2i(2i - 1)u^i \in HC_{2i}(k) = HC_{2i}^{(i)}(k)$ (cf. 4.6.10). Note that, under the topological interpretation mentioned in 10.1.6,

this generator corresponds (for $k = \mathbb{C}$) to the Bott element in $\pi_{2i+1}(U(i+1))$, up to a nonzero constant.

The conjecture is consistent with the computation of $H_n(gl_r(A))$ for $r \geq n$ given by Theorems 10.2.5 and 10.3.2 since $HC_n^{(i)}(A) = 0$ for $i > n$. It is also consistent with Theorem 10.3.4 since $HC_n^{(n)} = \Omega^n/d\Omega^{n-1}$ (cf. Theorem 4.6.8).

By the work of P. Hanlon [1986] Conjecture 10.3.9 for the algebras of truncated polynomials $k[x]/x^s$ implies the so-called Macdonald conjectures for the root systems A_n . These conjectures are known to be true by some other method. Note also that in Hanlon-Wales [1992] there is a proof of Conjecture 10.3.9 for $A = k[x]$.

Finally remark that Conjecture 10.3.9 implies two important properties which are not proved so far:

- $H_*(gl_r(A)) \rightarrow H_*(gl_{r+1}(A))$ is injective,
- $H_*(gl_r(A))$ is a graded symmetric algebra.

Exercises

E.10.3.1. Show that $HC_n^M(\mathcal{M}_r(A)) = 0$ if $r \geq 2$. [Use the stability result and the fact that $gl_s(\mathcal{M}_r(A)) = gl_{rs}(A)$.]

E.10.3.2. Show that there is an exact sequence

$$H_1(A_L, [A, A]) \rightarrow HC_1(A) \rightarrow HC_1^M(A) \rightarrow [A, A]/[A, [A, A]] \rightarrow 0,$$

where A_L means $gl_1(A)$. (Additive analogue of a sequence in algebraic K -theory due to D. Guin [1989, Theorem 4.2.1].)

E.10.3.3. Let A be an associative unital algebra over a commutative ring k . Suppose that A is free as a k -module. Show that for $n \geq 5$ the 2-cocycle $(\alpha, \beta) \mapsto [\text{tr}(\alpha \otimes \beta)] \in HC_1(A)$ determines the universal central extension $st_n(A)$ of $sl_n(A)$ (cf. Exercise E.10.2.5).

10.4 Homology with Coefficients in the Adjoint Representation

The computations performed in the previous sections were done with trivial coefficients. But the same method applies equally well when the coefficient module is the adjoint representation. T. Goodwillie [1985a] was the first to give a proof of this computation, that he applied to the study of relative K -theory groups.

Standing Assumption. The field k is of characteristic zero, A is a unital associative k -algebra and M is an A -bimodule.

10.4.1 The Adjoint Representation. Consider the k -module $\mathcal{M}_r(M)$ of $r \times r$ -matrices with coefficients in M . Since M is a bimodule over A , the products of matrices $x\alpha$ and αx are well-defined for any $x \in \mathcal{M}_r(M)$ and any $\alpha \in gl_r(A)$. Hence $\mathcal{M}_r(M)$ is a $gl_r(A)$ -module for the action

$$(x, \alpha) \mapsto [x, \alpha] = x\alpha - \alpha x .$$

This is called the *adjoint representation* for M , already described in 10.1.1 for $M = A$.

10.4.2 Theorem. *Let k be a characteristic zero field, A a unital associative k -algebra and M an A -bimodule. There is a canonical isomorphism of graded modules*

$$H_*(gl(A), \mathcal{M}(M)) \cong H_*(A, M) \otimes H_*(gl(A)) ,$$

where $H_*(A, M)$ is Hochschild homology of A with coefficients in M .

As a result $H_*(gl(A), \mathcal{M}(M))$ is computable from $H_*(A, M)$ and $HC_*(A)$.

10.4.3 First Step of the Proof of Theorem 10.4.2. By mimicking the first step of the computation of $H_*(gl(A))$ (cf. 10.2.9) we get a quasi-isomorphism of complexes

$$\mathcal{M}(M) \otimes \Lambda^* gl(A) \rightarrow \mathcal{M}(M) \otimes (\Lambda^* gl(A))_{gl} .$$

Mimicking the second step (cf. 10.2.10) and using the isomorphism of gl -modules $\mathcal{M}(M) \cong gl \otimes M$ yield an isomorphism

$$\Theta : \mathcal{M}(M) \otimes (\Lambda^n gl(A))_{gl} \cong M \otimes (k[S_{n+1}] \otimes A^{\otimes n})_{S_n} ,$$

where the action of $S_n = \text{Aut}\{1, \dots, n\}$ on $S_{n+1} = \text{Aut}\{0, \dots, n\}$ is by conjugation. As usual the action of S_n on $A^{\otimes n}$ is by place permutation and multiplication by the sign.

10.4.4 Proposition. *There is a canonical isomorphism*

$$\Psi : \bigoplus_{p+q=n} (C_p(A, M) \otimes (k[S_q] \otimes A^{\otimes q})_{S_q}) \cong M \otimes (k[S_{n+1}] \otimes A^{\otimes n})_{S_n} ,$$

where $C_p(A, M) = M \otimes A^{\otimes p}$.

Proof. It is sufficient to treat the case $M = k$. The point is to analyze the S_n -set S_{n+1} under the action described above.

Let (ϱ) be the orbit of $\varrho \in S_{n+1}$ under S_n . Suppose that the orbit of 0 under ϱ is of length $p + 1$. At the expense of changing the representative of (ϱ) one can always suppose that the orbit of 0 is $\{0, 1, \dots, p\}$. Let $\bar{\varrho}$ be the restriction of ϱ to $\{p + 1, \dots, n\}$ so that $\bar{\varrho} \in \text{Aut}\{p + 1, \dots, n\} \cong S_{n-p}$. This shows that, as a S_n -set, S_{n+1} is the disjoint union $\cup_{p=0, \dots, n} (\cup_{\bar{\pi}}(\pi))$, where $\bar{\pi}$

ranges over representatives for conjugacy classes in S_{n-p} . Note, for instance, that for $p = n$ the orbit of $\rho = (0 \ 1 \ \dots \ n)$ is S_n -free.

Applying this decomposition to the module $(k[S_{n+1}] \otimes A^{\otimes n})_{S_n}$ gives the expected isomorphism. \square

10.4.5 Corollary. *There is a canonical isomorphism of complexes*

$$\Xi : C_*(A, M) \otimes (\Lambda^* gl(A))_{gl} \cong (\mathcal{M}(M) \otimes \Lambda^* gl(A))_{gl} .$$

Proof. A computation analogous to formula (10.2.18.1) shows that the map $(a_0, \dots, a_n) \mapsto E_{01}^{a_0} \otimes E_{12}^{a_1} \wedge \dots \wedge E_{n0}^{a_n}$ induces a map of complexes

$$\xi : (C_*(A, M), b) \rightarrow ((\mathcal{M}(M) \otimes \Lambda^* gl(A))_{gl}, d) .$$

Therefore the composite Ξ :

$$\begin{aligned} C_*(A, M) \otimes (\Lambda^* gl(A))_{gl} &\xrightarrow{\xi \otimes id} (\mathcal{M}(M) \otimes \Lambda^* gl(A))_{gl} \otimes (\Lambda^* gl(A))_{gl} \\ &\hookrightarrow (\mathcal{M}(M) \otimes \Lambda^*(gl(A) \oplus gl(A)))_{gl} \xrightarrow{\oplus^*} (\mathcal{M}(M) \otimes \Lambda^* gl(A))_{gl} \end{aligned}$$

is a map of complexes.

In order to finish the proof, it is sufficient to show that $\Theta \circ \Xi = (id \otimes \Theta) \circ \Psi$. This follows from a straightforward computation of the images of the element $(a_0, \dots, a_p) \otimes E_{p+1, p+2}^{a_{p+1}} \wedge \dots \wedge E_{p+q, p+1}^{a_{p+q}}$ under these two composites. \square

10.4.6 End of the Proof of Theorem 10.4.2. Taking the homology in 10.4.5, the proof of 10.4.2 follows from 10.4.3 and 10.4.4. \square

Exercises

E.10.4.1. Show that under the hypothesis of Theorem 10.4.2 there are isomorphisms

$$\begin{aligned} H_n(gl_n(A), \mathcal{M}_n(M)) &\xrightarrow{\sim} H_n(gl_{n+1}(A), \mathcal{M}_{n+1}(M)) \xrightarrow{\sim} \dots \\ &\xrightarrow{\sim} H_n(gl(A), \mathcal{M}(M)) . \end{aligned}$$

Compute the first obstruction to stability.

E.10.4.2. Show that under the hypotheses of Theorem 10.4.2 there is a canonical isomorphism in cohomology

$$H^*(gl(A), \mathcal{M}(M)) \cong H^*(A, M) \otimes H^*(gl(A))$$

(cf. J. Brodzki [1990]).

E.10.4.3. Show that there is a well-defined map $H_*(\mathfrak{g}, \mathfrak{g}) \rightarrow H_{*+1}(\mathfrak{g})$ induced by

$$\alpha_0 \otimes \alpha_1 \wedge \dots \wedge \alpha_n \mapsto (-1)^n \alpha_0 \wedge \alpha_1 \wedge \dots \wedge \alpha_n .$$

Show that, for $\mathfrak{g} = gl(A)$, it is related to $I : HH_*(A) \rightarrow HC_*(A)$.

10.5 The Symplectic and Orthogonal Cases

What happens if, in the main theorem computing $H_*(gl(A))$ in terms of cyclic homology, one replaces the Lie algebra of matrices $gl(A)$ by the Lie algebra of skew-symmetric matrices or the Lie algebra of symplectic matrices? The answer is: replace cyclic homology by dihedral homology. The proof is along the same lines, the only difference is in the input from invariant theory. Stability theorems and obstruction to stability (at least in the symplectic case) are given.

In this section we follow Loday-Procesi [1988].

Standing Assumption. The field k is of characteristic zero, and A is a unital involutive associative k -algebra.

10.5.1 Involutive Algebras. Throughout this section the k -algebra A is equipped with an involution $a \mapsto \bar{a}$. This means that $\overline{ab} = \bar{b}\bar{a}$ and $\overline{\bar{a}} = a$. We always assume that this involution is trivial on k , in particular $\bar{1} = 1$. The element \bar{a} is called the *conjugate* of a . This involution is extended to matrices $\alpha \mapsto {}^t\alpha$ by the classical formula

$$({}^t\alpha)_{ij} = \bar{\alpha}_{ji} .$$

10.5.2 Skew-symmetric Matrices. By definition the Lie algebra of *skew-symmetric matrices* is the following sub-Lie algebra of $gl_r(A)$,

$$o_r(A) := \{ \alpha \in gl_r(A) \mid {}^t\alpha = -\alpha \} .$$

The Lie algebra $o_r(A)$ is closed under the Lie bracket since ${}^t(\alpha\beta) = {}^t\beta{}^t\alpha$ implies ${}^t([\alpha, \beta]) = [{}^t\beta, {}^t\alpha]$. The inductive limit of the inclusions $o_r(A) \hookrightarrow o_{r+1}(A)$ is denoted $o(A)$.

10.5.3 Symplectic Matrices. Consider the $2r \times 2r$ -matrix $J_r = j \oplus \dots \oplus j$, where

$$j = \begin{bmatrix} 0 & 1 \\ -1 & 0 \end{bmatrix} .$$

Define a new operation on $gl_{2r}(A)$ by

$${}^T\alpha := -J_r {}^t\alpha J_r .$$

By definition the Lie algebra of *symplectic matrices* is the following sub-Lie algebra of $gl_{2r}(A)$,

$$sp_{2r}(A) := \{ \alpha \in gl_{2r}(A) \mid {}^T\alpha = -\alpha \} .$$

The Lie algebra $sp_{2r}(A)$ is closed under the Lie bracket since ${}^t(\alpha\beta) = {}^t\beta{}^t\alpha$ and $J_r^2 = -id$ implies ${}^T([\alpha, \beta]) = [{}^T\beta, {}^T\alpha]$. The inductive limit of the inclusions $sp_{2r}(A) \hookrightarrow sp_{2r+2}(A)$ is denoted $sp(A)$.

10.5.4 Dihedral Homology in Characteristic Zero. Recall that in Sect.5.2 we have defined and studied dihedral homology of an involutive algebra A . Since we are working here over a characteristic zero field we can use the definition $HD_n(A) = H_n((C_*(A))_{D_*}, b)$ (cf. 5.2.8), where $(C_n(A))_{D_{n+1}} = (A^{\otimes n+1})_{D_{n+1}}$ is the coinvariant space for the action of the dihedral group $D_{n+1} = \{x_n, y_n \mid x_n^{n+1} = y_n^2 = 1 \text{ and } y_n x_n y_n^{-1} = x_n^{-1}\}$ given by

$$\begin{aligned} x_n(a_0, a_1, \dots, a_n) &= (-1)^n(a_n, a_0, \dots, a_{n-1}), \\ y_n(a_0, a_1, \dots, a_n) &= (-1)^{n(n+1)/2}(\bar{a}_0, \bar{a}_n, \bar{a}_{n-1}, \dots, \bar{a}_1). \end{aligned}$$

10.5.5 Theorem. *Let k be a characteristic zero field and let A be a unital involutive associative k -algebra. The restriction of $\text{tr}_* \circ \theta_*$ to the primitive part of $H_*(o(A))$ induces an isomorphism*

$$\text{tr}_* \circ \theta_* : \text{Prim } H_*(o(A)) \xrightarrow{\sim} HD_{*-1}(A).$$

The restriction of $\text{tr}_* \circ \theta_*$ to the primitive part of $H_*(sp(A))$ induces an isomorphism

$$\text{tr}_* \circ \theta_* : \text{Prim } H_*(sp(A)) \xrightarrow{\sim} HD_{*-1}(A).$$

10.5.6 Corollary. *With the same hypothesis as above, there are canonical isomorphisms of graded Hopf algebras*

$$H_*(o(A)) \cong \Lambda(HD_*(A)[1]) \quad \text{and} \quad H_*(sp(A)) \cong \Lambda(HD_*(A)[1]).$$

Remark that in the stable case skew-symmetric and symplectic matrices have the same homology, a fact which is not obvious a priori. Of course this is not true in the non-stable case (see 10.5.10 and 10.5.11).

10.5.7 Proof of Theorem 10.5.5 and Corollary 10.5.6. The proofs are along the same lines as in the gl -case. The only change is in the results of invariant theory which are going to be used. We sketch the parts of the proofs which mimic Sect. 10.2. To simplify the notation we write $g(A)$ for $o(A)$ or $sp(A)$, and, consequently, g for $o = o(k)$ or $sp = sp(k)$.

Let the group $\mathbb{Z}/2 = \mathbb{Z}/2\mathbb{Z}$ act on $gl(A)$ by $\alpha \mapsto -{}^t\alpha$ in the orthogonal case and by $\alpha \mapsto -{}^T\alpha$ in the symplectic case, so that in both cases $g(A)$ is identified with the coinvariant space

$$(10.5.7.1) \quad g(A) := gl(A)_{\mathbb{Z}/2} = (gl \otimes A)_{\mathbb{Z}/2}.$$

Consequently, we get the following sequence of isomorphisms

$$\begin{aligned} (10.5.7.2) \quad \Lambda^n g(A) &= (g(A)^{\otimes n})_{S_n} \cong ((gl(A)^{\otimes n})_{(\mathbb{Z}/2)^n})_{S_n} \\ &= ((gl(A)^{\otimes n})_{H_n}) \cong (gl^{\otimes n} \otimes A^{\otimes n})_{H_n}, \end{aligned}$$

where $H_n = (\mathbb{Z}/2)^n \rtimes S_n$ is the hyperoctahedral group (cf. 6.3.3).

In order to compute the homology of the CE-complex $(\Lambda^*g(A), d)$ we first take the coinvariants with respect to g to get, by the same argument as in 10.2.9, a quasi-isomorphism of complexes

$$(\Lambda^*g(A), d) \rightarrow ((\Lambda^*g(A))_g, d) .$$

Note that one can apply Proposition 10.1.8, since both o_r and sp_r are reductive Lie algebras.

By mimicking 10.2.10 with the aid of (10.5.7.2) we get an isomorphism

$$(10.5.7.3) \quad \Theta : (\Lambda^n g(A))_g \cong ((gl^{\otimes n})_g \otimes A^{\otimes n})_{H_n} \cong (k[S_{2n}/H_n] \otimes A^{\otimes n})_{H_n} .$$

In the last isomorphism we have applied the result of invariant theory stated in 9.5.7 for the orthogonal case and in 9.5.12 for the symplectic case.

The dihedral group $D_n = \mathbb{Z}/2 \rtimes \mathbb{Z}/n$ is embedded into $H_n = (\mathbb{Z}/2)^n \rtimes S_n$ by sending $\mathbb{Z}/2$ diagonally into $(\mathbb{Z}/2)^n$ and the generator of \mathbb{Z}/n to the cyclic permutation $\tau \in S_n$. Then, there is an isomorphism of graded symmetric algebras $\Lambda(\bigoplus_{n \geq 1} (k[H_n/D_n] \otimes A^{\otimes n})_{H_n}) \cong \bigoplus_{n \geq 0} ((k[S_{2n}/H_n] \otimes A^{\otimes n})_{H_n})$. A computation analogous to Proposition 10.2.16 shows that Θ is a coalgebra map and therefore

$$\text{Prim}(\Lambda^*g(A))_g \cong \left(\bigoplus_{n \geq 1} (k[H_n/D_n] \otimes A^{\otimes n})_{H_n} \right) .$$

Finally the sequence of isomorphisms

$$(k[H_n/D_n] \otimes A^{\otimes n})_{H_n} \cong (k \otimes A^{\otimes n})_{D_n} \cong (A^{\otimes n})_{D_n}$$

permits us to finish the proof of Theorem 10.5.5.

To finish the proof of Corollary 10.5.6 it suffices to remark that $o(A)$ and $sp(A)$ are closed under the direct sum of matrices so that the same argument as in the proof of Corollary 10.2.5 applies. \square

10.5.8 Remark. In the computation of $H_*(gl(A))$ performed in Sect. 10.2, we took the coinvariants with respect to the action of gl . But, in fact, we could as well take the coinvariants with respect to the action of o or of sp . This would give a slightly different proof of Theorem 10.2.4 . For instance (10.2.10.2) would become

$$\Theta : (\Lambda^n gl(A))_g \cong (k[S_{2n}/H_n] \otimes A^{\otimes n})_{S_n} .$$

This version is helpful to show, for instance, that the inclusion $o(A) \hookrightarrow gl(A)$ induces, on the primitive part of the homology, the natural inclusion $HD_*(A) \hookrightarrow HC_*(A)$.

10.5.9 Theorem (Stability for the Homology of $o_r(A)$ and $sp_{2r}(A)$). *Let k be a characteristic zero field and let A be a unital involutive associative k -algebra. For any integer $n \geq 1$ the stabilization maps induce isomorphisms*

$$\begin{aligned} H_n(o_{n+1}(A)) &\xrightarrow{\sim} H_n(o_{n+2}(A)) \xrightarrow{\sim} \dots \xrightarrow{\sim} H_n(o(A)), \\ H_n(sp_{2n}(A)) &\xrightarrow{\sim} H_n(sp_{2n+2}(A)) \xrightarrow{\sim} \dots \xrightarrow{\sim} H_n(sp(A)). \end{aligned}$$

Proof. This is a consequence of the stabilization results 9.5.7 and 9.5.12 of invariant theory. The proof is as in the gl -case (cf. Sect. 10.3). \square

10.5.10 Theorem (First Obstruction to Stability in the Symplectic Case). *Let k be a characteristic zero field and let A be a unital involutive associative k -algebra. For all $n \geq 1$ there is an exact sequence*

$$H_n(sp_{2n-2}(A)) \rightarrow H_n(sp_{2n}(A)) \xrightarrow{\text{Pf}_*} \Lambda_{A^+}^n(A^-/[A^+, A^-]) \rightarrow 0,$$

where $A^\pm = \{a \in A \mid \bar{a} = \pm a\}$, and Pf_* is induced by the Pfaffian.

In particular, if A is commutative with trivial involution ($\bar{a} = a$), then the map $H_n(sp_{2n-2}(A)) \rightarrow H_n(sp_{2n}(A))$ is surjective.

Proof. By the same arguments as in the proof of Theorem 10.3.4 this result is a consequence of Proposition 9.5.14 of invariant theory. \square

10.5.11 Remark on the Obstruction to Stability in the Orthogonal Case. Since the first nontrivial cokernel, $\text{Coker}((gl_{n-1}^{\otimes n})_{o_{n-1}} \rightarrow (gl_n^{\otimes n})_{o_n})$, is not one-dimensional (cf. 9.5.6) it is difficult to identify the first obstruction to stability in the orthogonal case.

Exercise

E.10.5.1. Make a conjecture about $H_*(o_r(A))$ and $H_*(sp_{2r}(A))$ in the commutative case, and verify it for $A = k$. [Mimick Conjecture 10.3.9.]

10.6 Non-commutative Homology (or Leibniz Homology) of the Lie Algebra of Matrices

In the definition of the Chevalley-Eilenberg complex of a Lie algebra \mathfrak{g} the module of chains is the exterior module. The non-commutative analog of the exterior module $\Lambda \mathfrak{g}$ is the tensor module $T\mathfrak{g}$. If one replaces \wedge by \otimes in the classical formula for the boundary map d of the CE-complex, then one gets a well-defined map on $T\mathfrak{g}$, but the relation $d^2 = 0$ is not valid anymore. However I discovered that, if one writes d so as to put the commutator $[x_i, x_j]$ at the place i when $i < j$ (see 10.6.2.1), then the relation $d^2 = 0$ is satisfied in the tensor (i.e. non-commutative) context. So, this gives rise to a new complex $(T\mathfrak{g}, d)$ for the Lie algebra \mathfrak{g} . The homology groups of this complex are denoted $HL_*(\mathfrak{g})$ and called the *non-commutative homology groups* of \mathfrak{g} .

In the proof of the relation $d^2 = 0$ in the tensor module case, I noticed that the only property of the Lie bracket, which is needed, is the *Leibniz relation* (see 10.6.1.1). So the complex $(T\mathfrak{g}, d)$ and its homology are defined for more general objects than Lie algebras, for the *Leibniz algebras* (cf. 10.6.1).

The main result of this section is the computation of $HL_*(gl(A))$ when A is an associative algebra over a characteristic zero field k . It takes the following form (Theorem 10.6.5),

$$HL_*(gl(A)) \cong T(HH_{*-1}(A)) .$$

So this result is analogous to what we proved for the Lie homology. In fact the natural map from the tensor module to the exterior module induces on the primitive part the natural map $I : HH_* \rightarrow HC_*$. The first part of the proof consists in mimicking the Lie algebra proof. On the other hand, the second part is specific and relies on a key construction due to C. Cuvier.

The same techniques as in the Lie case permit us to give a stability theorem (same bounds, cf. Theorem 10.6.15) and a computation of the first obstruction to stability (cf. Theorem 10.6.17). In the case of a commutative algebra A this computation takes the form of an exact sequence

$$HL_n(gl_{n-1}(A)) \rightarrow HL_n(gl_n(A)) \rightarrow \Omega_{A|k}^{n-1} \rightarrow 0 .$$

We end up this section with a conjecture about the computation of

$$HL_*(gl_r(A))$$

for fixed r and commutative A in terms of the λ -decomposition of $HH_*(A)$ (see 10.6.22).

Standing Assumption. The associative k -algebra A is unital.

10.6.1 Leibniz Algebras and Modules. By definition a *Leibniz algebra* \mathfrak{g} is a k -module equipped with a bilinear map

$$[-, -] : \mathfrak{g} \times \mathfrak{g} \rightarrow \mathfrak{g}$$

satisfying the *Leibniz relation*

$$(10.6.1.1) \quad [x, [y, z]] = [[x, y], z] - [[x, z], y] , \quad \text{for all } x, y, z \in \mathfrak{g} .$$

Since in this book we decided to place the coefficient module on the left-hand side, the Leibniz relation keeps the first entry at the first place. If we were placing the coefficient module on the right-hand side, then the Leibniz relation would have been

$$(10.6.1.1)' \quad [[x, y], z] = [x, [y, z]] - [y, [x, z]] .$$

Any Lie algebra is a Leibniz algebra (for the same bracket) since the classical Jacobi identity is equivalent to the Leibniz relation in presence of

the antisymmetry property of the bracket (cf. 10.1.1). On the other hand the quotient of the Leibniz algebra \mathfrak{g} by the ideal generated by the elements $[x, x]$, for all x in \mathfrak{g} , is a Lie algebra $\bar{\mathfrak{g}}$.

By definition a *Leibniz module* M over \mathfrak{g} is simply a Lie module over $\bar{\mathfrak{g}}$. Composing with $\mathfrak{g} \rightarrow \bar{\mathfrak{g}}$, the module structure on M gives rise to an action of \mathfrak{g} on M , still denoted $[-, -] : M \times \mathfrak{g} \rightarrow M$, which is bilinear and satisfies formula (10.6.1.1) for any $x \in M$ and any $y, z \in \mathfrak{g}$.

10.6.2 The Tensor Complex Associated to a Leibniz Algebra. For any Leibniz algebra \mathfrak{g} and any Leibniz \mathfrak{g} -module M we define a map $d : M \otimes \mathfrak{g}^{\otimes n} \rightarrow M \otimes \mathfrak{g}^{\otimes n-1}$ by the following formula (with our classical convention $(g_0, \dots, g_n) = (g_0 \otimes \dots \otimes g_n)$ for $g_0 \in M$ and $g_1, \dots, g_n \in \mathfrak{g}$):

$$(10.6.2.1) \quad d(g_0, \dots, g_n) := \sum_{0 \leq i < j \leq n} (-1)^j (g_0, \dots, g_{i-1}, [g_i, g_j], g_{i+1}, \dots, \hat{g}_j, \dots, g_n).$$

Note that the bracket $[g_i, g_j]$ is at the place $\inf(i, j)$. In particular for $i = 0$ this element appears as a first entry and so d is well-defined. If we were using relation (10.6.1.1)' instead of (10.6.1.1) then we should put the module M on the right-hand side and the commutator at the place $\sup(i, j)$. Note also (cf. 10.1.3) that the surjection from the tensor product to the exterior product induces, for any Lie algebra \mathfrak{g} and any Lie module M , a commutative diagram

$$(10.6.2.2) \quad \begin{array}{ccc} M \otimes \mathfrak{g}^{\otimes n} & \xrightarrow{d} & M \otimes \mathfrak{g}^{\otimes n-1} \\ \downarrow & & \downarrow \\ M \otimes \Lambda^n \mathfrak{g} & \xrightarrow{d} & M \otimes \Lambda^{n-1} \mathfrak{g}. \end{array}$$

10.6.3 Lemma. *For any Leibniz algebra \mathfrak{g} and any \mathfrak{g} -module M , the map $d : M \otimes \mathfrak{g}^{\otimes n} \rightarrow M \otimes \mathfrak{g}^{\otimes n-1}$ defined above satisfies $d^2 = 0$. Therefore the sequence*

$$\dots \rightarrow M \otimes \mathfrak{g}^{\otimes n} \xrightarrow{d} M \otimes \mathfrak{g}^{\otimes n-1} \xrightarrow{d} \dots \rightarrow M \otimes \mathfrak{g} \rightarrow M$$

is a well-defined complex $(M \otimes T\mathfrak{g}, d)$.

Proof. Let us recall that $g \in \mathfrak{g}$ acts on $\alpha = (g_0, g_1, \dots, g_n)$ by

$$[\alpha, g] := \sum_{i=0}^n (g_0, \dots, [g_i, g], \dots, g_n).$$

First, we prove the following relation by induction on n ,

$$(10.6.3.0) \quad d[\alpha, g] = [d\alpha, g] \quad \text{for any } \alpha = (g_0, g_1, \dots, g_n).$$

This equality is trivial for $n = 0$. For $n = 1$ it is precisely relation (10.6.1.1) since

$$d[\alpha, g] = d((g_0, g], g_1) + (g_0, [g_1, g])) = -[[g_0, g], g_1] - [g_0, [g_1, g]] ,$$

and $[d\alpha, g] = [-[g_0, g_1], g]$.

Suppose that (10.6.3.0) is true for $n - 1$, and let us prove it for n . We adopt the following notation, $y := g_n$ and $\beta := (g_0, g_1, \dots, g_{n-1})$ so that $\alpha = (\beta, y)$. From the definition of the action and of the boundary map d given in (10.6.2.1), it is immediate that

$$(10.6.3.1) \quad d(\beta, y) = (d\beta, y) + (-1)^n[\beta, y] ,$$

$$(10.6.3.2) \quad [(\beta, y), g] = ([\beta, g], y) + (\beta, [y, g]) .$$

The proof of formula (10.6.3.0) is as follows,

$$\begin{aligned} d[\alpha, g] &= d[(\beta, y), g] = d(([\beta, g], y) + (\beta, [y, g])) && \text{by (10.6.3.2),} \\ &= (d[\beta, g], y) + (-1)^n[[\beta, g], y] + (d\beta, [y, g]) \\ &\quad + (-1)^n[\beta, [y, g]] && \text{by (10.6.3.1),} \\ &= ([d\beta, g], y) + (d\beta, [y, g]) \\ &\quad + (-1)^n([\beta, [y, g]] + [[\beta, g], y]) && \text{by induction,} \\ &= [(d\beta, y), g] + (-1)^n[[\beta, y], g] && \text{by (10.6.3.2) and (10.6.1.1),} \\ &= [d(\beta, y), g] = [d\alpha, g] && \text{by (10.6.3.1) and definition of } \alpha . \end{aligned}$$

The proof of $d^2 = 0$ is by induction on n . For $n = 0$ and 1 it is trivial. For $n = 2$ it is precisely formula (10.6.1.1). Then, by induction we get

$$\begin{aligned} d^2\alpha &= dd(\beta, y) = d((d\beta, y) + (-1)^n[\beta, y]) && \text{by (10.6.3.1),} \\ &= (d^2\beta, y) + (-1)^{n-1}[d\beta, y] + (-1)^n[d\beta, y] && \text{by (10.6.3.1) and (10.6.3.0),} \\ &= (d^2\beta, y) = 0 && \text{by induction since degree } \beta = \text{degree } \alpha - 1 . \quad \square \end{aligned}$$

10.6.4 Homology of Leibniz Algebras (Leibniz Homology). By definition the *homology of the Leibniz algebra* \mathfrak{g} over k with coefficients in the \mathfrak{g} -module M is the homology of the tensor complex $(M \otimes T\mathfrak{g}, d)$ and is denoted $HL_*(\mathfrak{g}, M)$. When $M = k$ is equipped with the trivial structure ($[m, g] = 0$), these groups are denoted by $HL_*(\mathfrak{g})$.

Note that $HL_0(\mathfrak{g}) = k$ and $HL_1(\mathfrak{g}) = \mathfrak{g}/[\mathfrak{g}, \mathfrak{g}]$.

Since any Lie algebra \mathfrak{g} is a Leibniz algebra, the groups $HL_n(\mathfrak{g})$ are well-defined for any Lie algebra \mathfrak{g} and called the *Leibniz homology groups* of \mathfrak{g} . There is a natural map

$$(10.6.4.1) \quad HL_*(\mathfrak{g}) \rightarrow H_*(\mathfrak{g})$$

which is induced by the natural map from the tensor power to the exterior power (cf. 10.6.2.2) (of course this map exists more generally for any \mathfrak{g} -module M). It is an isomorphism for $n = 0$ and $n = 1$, but certainly not higher up in general, since, for any abelian Lie algebra \mathfrak{a} , one has $HL_n(\mathfrak{a}) = \mathfrak{a}^{\otimes n}$ and $H_n(\mathfrak{a}) = \wedge^n \mathfrak{a}$.

10.6.5 Theorem. *Let A be a unital algebra over a characteristic zero field k . The non-commutative homology of the Lie algebra of matrices $gl(A)$ is canonically isomorphic to the tensor module over the Hochschild homology of A shifted by 1. In other words there is a canonical isomorphism*

$$HL_*(gl(A)) \cong T(HH_*(A)[1]) .$$

Proof. The proof is in four steps.

- (a) First, we take the coinvariants of the tensor module complex with respect to gl to get a quasi-isomorphic complex.
- (b) Second, we apply invariant theory to simplify the new complex, thus getting rid of the matrices. The resulting complex, described in terms of A and of the symmetric groups, is denoted $L(A)[1]$.
- (c) Third, we show that the complex of primitive elements of $L(A)$ is quasi-isomorphic to the Hochschild complex $C(A)$. This step (due to Cuvier) is the crucial one unlike in the commutative case.
- (d) Fourth, by using the technical result of the preceding step, we generalize Cuvier’s proof to show that there is a quasi-isomorphism between $L(A)$ and $T(C(A))$.

10.6.6 First Step. From the property of the action of gl_r on $(gl_r A)^{\otimes n}$ with respect to the differential (cf. 10.6.3.0), the epimorphism of complexes

$$(Tgl_r A, d) \rightarrow ((Tgl_r A)_{gl_r}, d)$$

is well-defined. Here $Tgl_r A$ stands for $T(gl_r(A))$. By the same argument as in 10.2.9 (reductivity of gl_r), this map is a quasi-isomorphism.

10.6.7 Second Step. By mimicking (10.2.10.1), we consider the following sequence of isomorphisms,

$$(10.6.7.1) \quad \Theta : ((gl_r A)^{\otimes n})_{gl_r} \cong (gl_r^{\otimes n} \otimes A^{\otimes n})_{gl_r} \cong (gl_r^{\otimes n})_{gl_r} \otimes A^{\otimes n} \cong I_{n,r} \otimes A^{\otimes n} .$$

The composite Θ is essentially $T^* \otimes id_{A^{\otimes n}}$, of which T^* was made explicit in 9.2.11. The last isomorphism relies on Theorem 9.2.7 of invariant theory. Since $I_{n,r} = k[S_n]$ when $r \geq n$, it follows that the non-commutative homology of $gl(A)$ is the homology of the complex

$$\dots \rightarrow k[S_{n+1}] \otimes A^{\otimes n+1} \xrightarrow{d} k[S_n] \otimes A^{\otimes n} \rightarrow \dots ,$$

which we denote by $L_*(A)$ or simply $L(A)$. More precisely we put

$$L_n(A) := k[S_{n+1}] \otimes A^{\otimes n+1} ,$$

and the differential d is obtained from (10.6.2.1) by applying the isomorphism Θ . The conclusion of these two steps is that there is an isomorphism

$$(10.6.7.2) \quad \Theta_* : HL_*(gl(A)) \cong H_*(L(A)[1]) .$$

Remember that, for a graded module M , the notation $M[1]$ means $(M[1])_n = M_{n-1}$.

10.6.8 Third Step. Let us first introduce some notation. Put $P_n = P_n(A) := k[U_{n+1}] \otimes A^{\otimes n+1}$, where U_{n+1} is the conjugation class of the cycle $\tau = (0\ 1\ 2 \dots n) \in S_{n+1}$. Note that, now, we think of S_{n+1} as the group of automorphisms of the set $\{0, \dots, n\}$. We adopt the notation $\underline{a} = (a_0, \dots, a_n) \in A^{\otimes n+1}$. The image of an element of P_n under the boundary map d of L_* is an element of P_{n-1} (cf. 10.6.10 below). The restriction of d to P_n is denoted b ,

$$P(A) : \quad \dots \rightarrow k[U_{n+1}] \otimes A^{\otimes n+1} \xrightarrow{b} k[U_n] \otimes A^{\otimes n} \rightarrow \dots .$$

This notation is justified by the following fact. By computing at the Lie algebra level (as in 10.2.11, see again 10.6.10), it is easily seen that the image of $\tau \otimes \underline{a}$ under b is precisely $\tau \otimes b(\underline{a})$, where, in this last expression, b is the Hochschild boundary. Therefore the modules $\tau \otimes A^{\otimes n+1}$, $n \geq 0$, form a subcomplex of $P(A)$, that we identify with the Hochschild complex $C(A)$.

The inclusion $\underline{a} \mapsto \tau \otimes \underline{a}$ is denoted $\iota : C(A) \hookrightarrow P(A)$. The aim of this step is to prove the following

10.6.9 Theorem. *For any ring k and any unital k -algebra A , there is a map of complexes $\psi : P(A) \rightarrow C(A)$ such that*

- (a) $\psi \circ \iota = id_{C(A)}$,
- (b) $\iota \circ \psi$ is homotopic to $id_{P(A)}$.

As a consequence there is a canonical isomorphism

$$\iota_* : HH_*(A) = H_*(C(A)) \rightarrow H_*(P(A)) .$$

Note that we did not assume any characteristic hypothesis in this statement.

Proof. First, let us fix some notation. Let $\sigma \in U_{n+1}$ be written as a cycle $\sigma = (\omega_0 \omega_1 \dots \omega_n)$. Then $\omega : \{0, \dots, n\} \rightarrow \{0, \dots, n\}, \omega(i) = \omega_i$, is a permutation and $\sigma = \omega\tau\omega^{-1}$. We impose the condition $\omega_0 = 0$. Thus, ω is uniquely determined by σ . Note that the equality $\omega_j = \sigma^j(0)$ defines ω_j for any $j \in \mathbb{Z}$.

Define $\psi : P_n = k[U_{n+1}] \otimes A^{\otimes n+1} \rightarrow A^{\otimes n+1} = C_n(A)$ by

$$(10.6.9.1) \quad \psi(\sigma \otimes \underline{a}) := \text{sgn}(\omega)\omega^{-1}(\underline{a}) = \text{sgn}(\omega)(a_{\omega_0}, a_{\omega_1}, \dots, a_{\omega_n}).$$

Since $\omega = id$ when $\sigma = \tau$, it follows immediately that $\psi \circ \iota = id$, and this proves part (a) of the theorem.

Here is the plan of the proof of part (b) of the theorem. First we construct an endomorphism t of P_n , whose restriction to $\tau \otimes A^{\otimes n+1} \cong C_n(A)$ is the cyclic operator. It will satisfy the same conditions as the cyclic operator with respect to the face operators (cf. 10.6.13), which define the differential map of P_* . Though this new operator is not cyclic, we prove in 10.6.15 that it satisfies

$$(10.6.9.2) \quad t^{n+1} = \iota \circ \psi.$$

In this context, there is also defined an extra degeneracy s (cf. 10.6.12), which gives rise to a generalization of Connes operator B by $B := (1 - t)s(1 + t + \dots + t^n) : P_n \rightarrow P_{n+1}$. We show in 10.6.14 that it satisfies

$$(10.6.9.3) \quad bB + Bb = id_{P_n} - t^{n+1}.$$

From the compatibility of t with the boundary map b of $P(A)$ and (10.6.9.2), it follows that ψ is a map of complexes. Then, (10.6.9.2) and (10.6.9.3) imply that $\iota \circ \psi$ is homotopic to id_P , which is statement (b).

First we interpret b on P_* as $\Sigma(-1)^i d_i$ for some d_i 's.

10.6.10 The Face Maps on P_* , Notation. Let x be the class of $E_{0\sigma(0)}^{a_0} \otimes E_{1\sigma(1)}^{a_1} \otimes \dots \otimes E_{n\sigma(n)}^{a_n}$ in $((gl(A)^{\otimes n+1})_{gl})$. Note that since the coefficient module is k , the entry $E_{i\sigma(i)}^{a_i}$ plays the role of g_{i+1} in the formula 10.6.2.1. The image of x in P_{n+1} is $\sigma \otimes \underline{a}$. Consider formula (10.6.2.1), giving $d(x)$. In the summation there are only $n + 1$ non-trivial terms because $\sigma \in U_{n+1}$ and $[E_{ij}, E_{kl}] = 0$ if $j \neq k$ and $l \neq i$. Let $\tilde{d}_i(x)$ be the element of $((gl(A)^{\otimes n+1})_{gl})$ which is $(-1)^i$ times the term in the summation which involves the commutator

$$\left[E_{\omega_i \omega_{i+1}}^{a_{\omega_i}}, E_{\omega_{i+1} \omega_{i+2}}^{a_{\omega_{i+1}}} \right].$$

By definition the *face map* $d_i : P_n \rightarrow P_{n-1}$, $0 \leq i \leq n$, is given by $d_i = \Theta \tilde{d}_i \Theta^{-1}$. From this definition of d_i , it is clear that, on P_n , one has $b = \sum_{i=0}^n (-1)^i d_i$. Explicitly $d_i(\sigma \otimes \underline{a}) = (-1)^{i+r+1}(\sigma' \otimes \underline{a}')$, where $r = \sup(\omega_i, \omega_{i+1})$, the cycle σ' is obtained from σ by deleting r and rearranging the numbering, \underline{a}' is obtained from \underline{a} by deleting a_r and replacing a_s (for $s = \inf(\omega_i, \omega_{i+1})$) by $a_{\omega_i} a_{\omega_{i+1}}$ if $r = \omega_{i+1}$ and by $-a_{\omega_i} a_{\omega_{i+1}}$ if $r = \omega_i$.

10.6.11 Lemma. *On $P_n(A)$ one has $d_i d_j = d_{j-1} d_i$ when $i < j$.*

Proof. Since $b^2 = 0$ is valid for any ring A , one can suppose that the variables a_1, \dots, a_n are independent (even non-commuting). In the expansion $b^2(x) =$

$\sum_{i < j} (-1)^{i+j} (d_i d_j - d_{j-1} d_i)(x)$ the only terms, which involve both products $a_{\omega(i)} a_{\omega(i+1)}$ and $a_{\omega(j)} a_{\omega(j+1)}$, are $d_i d_j(x)$ and $d_{j-1} d_i(x)$. Since $b^2(x) = 0$, this implies $d_i d_j = d_{j-1} d_i$. \square

The following lemmas will lead to the proof of the main theorem.

10.6.12 Lemma-Definition. *Let the extra degeneracy $s = s_{-1} : P_n \rightarrow P_{n+1}$ be given by $s(\sigma \otimes \underline{a}) := s(\sigma) \otimes s(\underline{a})$, where, as a cycle, $s(\sigma) := (0 \ \omega_0 + 1 \ \omega_1 + 1 \dots \omega_n + 1)$ for $\sigma = (\omega_0 \ \omega_1 \dots \omega_n)$, and $s(\underline{a}) := (1, a_0, \dots, a_n)$. Then one has*

$$d_0 s = id_{P_n}, \quad \text{and} \quad d_i s = s d_{i-1} : P_n \rightarrow P_n \quad \text{for} \quad 0 < i \leq n,$$

(but $d_{n+1} s \neq s d_n$).

Proof. In terms of elementary matrices (cf. 10.2.11), s is given by

$$s \left(E_{0\sigma(0)}^{a_0} \otimes \dots \otimes E_{n\sigma(n)}^{a_n} \right) = E_{0s(\sigma)(0)}^1 \otimes E_{1s(\sigma)(1)}^{a_0} \otimes \dots \otimes E_{n+1s(\sigma)(n)}^{a_n}.$$

Since $s(\sigma)(0) = \omega_0 + 1 = 1$, it follows that d_0 of this element is obtained by performing the commutator of the first two entries,

$$\left[E_{0s(\sigma)(0)}^1, E_{1s(\sigma)(1)}^{a_0} \right] = E_{0s(\sigma)(1)}^{a_0}.$$

So it is clear that $d_0 s = id$. The other formula is proved similarly. \square

10.6.13 Corollary-Definition. *Put $t := (-1)^n d_{n+1} s : P_n \rightarrow P_n$ and $N := \sum_{i=0}^n t^i$. Then one has*

- (a) $d_i t = -t d_{i-1}, i > 0$, and $d_0 t = (-1)^n d_n$,
- (b) $b(id - t) = (id - t)b', Nb = b'N, b's + sb' = id$,
- (c) $(id - t)N = id - t^{n+1}$,
- (d) *the restriction of t to $\tau \otimes A^{\otimes n+1} \cong C_n(A)$ is the cyclic operator.*

Proof. This corollary follows from the formulas of Lemmas 10.6.11 and 10.6.12 as follows. For (a) we get

$$d_i t = (-1)^n d_i d_{n+1} s = (-1)^n d_n d_i s = (-1)^n d_n s d_{i-1} = -t d_{i-1}$$

in the range $0 < i \leq n$, and

$$d_0 t = (-1)^n d_0 d_{n+1} s = (-1)^n d_n d_0 s = (-1)^n d_n.$$

The first two relations of (b) were proved in Lemma 2.1.1 as consequences of relations (a). For the last relation of (b) one has

$$b's = \sum_{i=0}^n (-1)^i d_i s = d_0 s + \sum_{i=1}^n (-1)^i d_i s = id - sb'.$$

Formula (c) and statement (d) are straightforward. \square

10.6.14 Lemma. $bB + Bb = id - t^{n+1}$ on P_n for $B := (id - t)sN$.

Proof. This is a consequence of (b) and (c) in the preceding lemma since

$$b(id - t)sN + (id - t)sNb = (id - t)(b's + sb')N = (id - t)N = id - t^{n+1}. \quad \square$$

10.6.15 Lemma. $t^{n+1} = \iota \circ \psi$ and so ψ is a map of complexes.

Proof. From the definitions of d_{n+1} and s we have

$$t(\sigma \otimes \underline{a}) = (-1)^{\omega_n} (0 \bar{\omega}_1, \dots, \bar{\omega}_n) \otimes (a_{\omega_n}, a_0, \dots, \widehat{a_{\omega_n}}, \dots, a_n),$$

where $\bar{\omega}_i = \omega_{i-1} + 1$ if $\omega_{i-1} < \omega_n$, and $\bar{\omega}_i = \omega_{i-1}$ if $\omega_{i-1} > \omega_n$.

Note that, in the cycle, n appears under the form $(n - 1) + 1$. Remember that $\omega_0 = 0$. Therefore the involved cycle is of the form $(0 \ 1 \ \omega_1 + 1 \ \dots)$. For t^2 , it is of the form $(0 \ 1 \ 2 \ \omega_1 + 2 \ \dots)$. By the end we get

$$t^{n+1}(\sigma \otimes \underline{a}) = \text{sgn}(\omega)(0 \ 1 \ 2 \ \dots \ n) \otimes (a_{\omega_0}, \dots, a_{\omega_n}) = \iota \circ \psi(\sigma \otimes \underline{a}),$$

as expected (cf. 10.6.9.1). The commutation property $bt^{n+1} = t^{n+1}b$ is a consequence of (10.6.13.a). \square

10.6.16 Fourth Step and End of the Proof of Theorem 10.6.5. The inclusion map ι extends naturally to an inclusion map of complexes

$$\iota_{(\cdot)} : T(C[1]) \hookrightarrow T(P[1]) \hookrightarrow L[1],$$

where T is the tensor module functor. More precisely $\iota_{(\cdot)}$ is given by

$$\begin{aligned} \iota_{(\cdot)}((a_0, \dots, a_{u-1}) \otimes \dots \otimes (a_r, \dots, a_{r+v-1}) \otimes \dots \otimes (a_s, \dots, a_n)) \\ = ((0 \ 1 \ \dots \ u - 1) \dots (r \ r + 1 \ \dots \ r + v - 1) \dots (s \ \dots \ n)) \otimes \underline{a}. \end{aligned}$$

Note that the entries $0, 1, \dots, u - 1, \dots, r, r + 1, \dots, r + v - 1, \dots, s, \dots, n$, are in increasing order.

Let us write the permutation $\sigma \in S_{n+1}$ as a product of m cycles of length u, \dots, v, \dots, w , with the conditions that, in the notation

$$\sigma = (\omega_0 \dots \omega_{u-1}) \dots (\omega_r \dots \omega_{r+v-1}) \dots (\omega_s \dots \omega_n),$$

- each of the first entries $\{\omega_0, \dots, \omega_r, \dots, \omega_s\}$ of involved cycles is the smallest number in its cycle,
- $0 = \omega_0 < \dots < \omega_r < \dots < \omega_s$. Therewith the permutation ω is uniquely determined, and one has

$$\begin{aligned} \sigma &= \omega(\xi_u, \dots, r, \dots) \omega^{-1} \\ &= \omega((0 \ 1 \ \dots \ u - 1) \dots (r \ r + 1 \ \dots \ r + v - 1) \dots (s \ \dots \ n)) \omega^{-1}. \end{aligned}$$

With the aid of this notation one can define a map

$$\psi_{(\)} : L \rightarrow T(C) \quad \text{by} \quad \psi_{(\)}(\sigma \otimes \underline{a}) := \xi_u, \dots, r, \dots \otimes \text{sgn}(\omega) \omega^{-1}(\underline{a}).$$

We prove below that $\psi_{(\)}$ is a map of complexes. It is immediate to check that

$$(a) \quad \psi_{(\)} \iota_{(\)} = id_{TC}.$$

Our aim is to construct operators

$$B_{(\)} : L_* \rightarrow L_{*+1} \quad \text{and} \quad t^{(\)} : L_* \rightarrow L_*,$$

such that

$$(10.6.16.1) \quad t^{(\)} = \iota_{(\)} \psi_{(\)}.$$

$$(10.6.16.2) \quad dB_{(\)} + B_{(\)}d = id_L - t^{(\)},$$

These two relations imply

$$(b) \quad dB_{(\)} + B_{(\)}d = id_L - \iota_{(\)} \psi_{(\)}.$$

Relation (10.6.16.1) and properties of $t^{(\)}$ will imply that $\psi_{(\)}$ is a map of complexes. Relations (a) and (b) imply that $T(C[1])$ is quasi-isomorphic to $L[1]$. Since the homology of a tensor complex is the tensor complex of its homology by the Künneth theorem, we are done,

$$HL_*(gl(A)) \cong^{e_*} H_*(L[1]) \cong^{e_*} H_*(T(C[1])) \cong T(H_*(C[1])) = T(HH_{*-1}(A)).$$

The proofs of (10.6.16.1–2) are done in the following subsection, where the construction of $B_{(\)}$ mimicks the construction, in the tensor framework, of a homotopy from a homotopy on the primitives.

10.6.17 The Operators $s_{(i)}$, $t_{(i)}$, $B_{(i)}$ and Proofs of (10.6.16.1–2).

Remember that the differential map $b_{(\)}$ on the tensor complex $T(C[1])$ is given by $b_{(\)} = \sum_{i=1}^m b_{(i)}$, where

$$b_{(i)}(c_1 \otimes \dots \otimes c_i \otimes \dots \otimes c_m) = \pm(c_1 \otimes \dots \otimes b(c_i) \otimes \dots \otimes c_m).$$

In other words, applying $b_{(i)}$ consists, up to sign, in performing b on the i th component.

Similarly, the differential $d : L[1] \rightarrow L[1]$ can be written $d = \sum_{i=1}^m d_{(i)}$, where $d_{(i)}$ consists in performing b (i.e. the restriction of d to P) on the i th component of $\sigma \otimes \underline{a}$, shifting the indices accordingly, and multiplying by the appropriate sign. For instance,

$$\begin{aligned}
 d_{(2)}((041)(235) \otimes \underline{a}) &= (031)(24) \otimes (a_0, a_1, a_2 a_3, a_4, a_5) \\
 &\quad + (041)(23) \otimes (a_0, a_1, a_2, a_3 a_5, a_4) \\
 &\quad - (041)(23) \otimes (a_0, a_1, a_5 a_2, a_3, a_4) .
 \end{aligned}$$

The operator $t_{(i)}$ (resp. $s_{(i)}$) is defined on $\sigma \otimes \underline{a}$ by applying t , as given in 10.6.13, (resp. s as given in 10.6.12) on the i th component of $\sigma \otimes \underline{a}$, shifting the indices accordingly, and multiplying by the appropriate sign. For instance,

$$\begin{aligned}
 t_{(2)}((041)(235) \otimes \underline{a}) &= -(051)(234) \otimes (a_0, a_1, a_5, a_2, a_3, a_4) , \\
 s_{(2)}((041)(235) \otimes \underline{a}) &= (051)(2346) \otimes (a_0, a_1, 1, a_2, a_3, a_4, a_5) .
 \end{aligned}$$

Then we define

$$t^{(\cdot)} := t_{(1)}^u \circ \dots \circ t_{(i)}^v \circ \dots \circ t_{(m)}^w .$$

Note that the operators $t_{(1)}^u, \dots, t_{(m)}^w$, where u, \dots, v, \dots, w are the lengths of the cycles, commute with each other. From the definition of $t_{(\cdot)}$ and the properties of t (cf. Lemma 10.6.14), it is clear that $t^{(\cdot)}$ is a morphism of complexes as announced, and that $t^{(\cdot)} = \iota_{(\cdot)} \psi_{(\cdot)}$.

The operator $B_{(i)}$ is defined on $\sigma \otimes \underline{a}$ by applying $\iota\psi$ on the first $(i - 1)$ components, B on the i th component, and id on the remaining $(m - i)$ components, shifting the indices accordingly, and multiplying by the appropriate sign. In other words,

$$B_{(i)} := ((\iota\psi)^{\otimes i-1} \otimes id^{\otimes m-i+1}) (id - t_{(i)}) s_{(i)} (1 + t_{(i)} + \dots + t_{(i)}^v) .$$

Then we put

$$B_{(\cdot)} := \sum_{i=1}^m B_{(i)} .$$

Let us, now, prove that $B_{(\cdot)}$ is a homotopy from $t^{(\cdot)}$ to id . We compute

$$\begin{aligned}
 dB_{(\cdot)} + B_{(\cdot)}d &= \left(\sum_i d_{(i)} \right) \left(\sum_j B_{(j)} \right) + \left(\sum_j B_{(j)} \right) (\sum_i d_{(i)}) \\
 &= \sum_i (d_{(i)} B_{(i)} + B_{(i)} d_{(i)}) ,
 \end{aligned}$$

since $d_{(i)}$ and $B_{(j)}$ anticommute when $i \neq j$,

$$= \sum_i ((\iota\psi)^{\otimes i} \otimes id^{\otimes m-i} - (\iota\psi)^{\otimes i+1} \otimes id^{\otimes m-i-1})$$

by Lemmas 10.6.14 and 10.6.15,

$$= id^{\otimes m} - (\iota\psi)^{\otimes m} = id_L - \iota_{(\cdot)} \psi_{(\cdot)} . \quad \square$$

This finishes the fourth step and therefore the proof of Theorem 10.6.5. □

We now state, and then prove, the stability results for $HL_*(gl_r(A))$, $r \geq 1$.

10.6.18 Theorem. *Let k be a characteristic zero field and let A be a unital k -algebra. For any integer $n \geq 1$ the stabilization maps induce isomorphisms*

$$HL_n(gl_n(A)) \xrightarrow{\sim} HL_n(gl_{n+1}(A)) \xrightarrow{\sim} \dots \xrightarrow{\sim} HL_n(gl(A)) .$$

The proof will be performed in 10.6.21.

10.6.19 A Milnor-Type Hochschild Homology Group. In order to describe the obstruction to stability in the non-commutative case we need to introduce the following group. By definition $HH_n^M(A)$ is the quotient of $A \otimes A^n A$ (taken over k) by the relations

(10.6.19.1)

$$a_0 \otimes a_1 \wedge \dots \wedge (a_i a'_i - a'_i a_i) \wedge \dots \wedge a_n = 0 \quad \text{for all } i \quad (\text{including } i = 0) ,$$

(10.6.19.2)

$$(a_0 a_1 \otimes a_2 - a_0 \otimes a_1 a_2 + a_2 a_0 \otimes a_1) \wedge a_3 \wedge \dots \wedge a_n = 0 \quad \text{for all } a_i, a'_i \in A .$$

If A is commutative, then condition (10.6.19.1) is void and the following map is an isomorphism:

$$HH_n^M(A) \rightarrow \Omega_{A|k}^n, \quad a_0 \otimes a_1 \wedge \dots \wedge a_n \mapsto a_0 da_1 \dots da_n .$$

10.6.20 Theorem (First Obstruction to Stability). *Let k be a characteristic zero field and let A be a unital associative k -algebra. For all $n \geq 1$ there is an exact sequence*

$$HL_n(gl_{n-1}(A)) \rightarrow HL_n(gl_n(A)) \rightarrow HH_{n-1}^M(A) \rightarrow 0 ,$$

which takes the form

$$HL_n(gl_{n-1}(A)) \rightarrow HL_n(gl_n(A)) \rightarrow \Omega_{A|k}^{n-1} \rightarrow 0$$

when A is commutative.

Again we remark that this obstruction is the submodule of the primitive part generated by the products of elements of low degree.

10.6.21 Proof of Theorems 10.6.18 and 10.6.20. Let us denote by $L_n(r) := I_{n,r} \otimes A^{\otimes n}$ the module isomorphic to $(T^n gl_r A)_{gl_r}$ by the sequence of isomorphisms of (10.6.7.1). We know that

$$\Theta_* : HL_*(gl_r(A)) \cong H_*(L_*(r), d)$$

is an isomorphism. The following is a short exact sequence of (horizontal) complexes

(10.6.21.1)

$$\begin{array}{ccccccc}
 \dots \rightarrow & L_{n+1}(n-1) & \rightarrow & L_n(n-1) & \rightarrow & L_{n-1}(n-1) & \rightarrow \dots \\
 & \downarrow & & \downarrow & & \downarrow & \\
 \dots \rightarrow & L_{n+1}(n) & \xrightarrow{d} & L_n(n) & \rightarrow & L_{n-1}(n) & \rightarrow \dots \\
 & \downarrow & & \downarrow \pi & & \downarrow & \\
 \dots \rightarrow & \cdot & \rightarrow & A^{\otimes n} & \rightarrow & 0 & \rightarrow \dots
 \end{array}$$

The inclusion of $L_*(n-1)$ into $L_*(n)$ is induced by the inclusion of $I_{*,n-1}$ into $I_{*,n}$. Therefore the cokernel complex is $(I_{m,n}/I_{m,n-1}) \otimes A^{\otimes m}$ in degree m . In particular this module is 0 for $m > n$ and is

$$L_n(n)/L_n(n-1) = (I_{n,n}/I_{n,n-1}) \otimes A^{\otimes n} \cong k \otimes A^{\otimes n} = A^{\otimes n}$$

for $m = n$ (cf. 9.2.6 and Corollary 9.2.9). Note that the surjective map $\pi : k[S_n] \otimes A^{\otimes n} \rightarrow A^{\otimes n}$ is $\text{sgn} \otimes \text{id}$.

By taking the homology in (10.6.21.1) we get a long exact sequence

$$\begin{aligned}
 HL_n(gl_{n-1}A) \rightarrow HL_n(gl_nA) &\xrightarrow{\pi_*} A^{\otimes n}/\approx \rightarrow HL_{n-1}(gl_{n-1}A) \\
 &\rightarrow HL_{n-1}(gl_nA) \rightarrow 0 \rightarrow \dots
 \end{aligned}$$

This proves that stability begins at least at $HL_{n-2}(gl_{n-1}(A))$ (or equivalently at $HL_n(gl_{n+1}(A))$). In order to prove that it really begins at $HL_{n-1}(gl_{n-1}(A))$ (or equivalently at $HL_n(gl_n(A))$), which would finish the proof of Theorem 10.6.18) it suffices to prove that π_* is surjective. The proof is exactly as in Proposition 10.3.6.

In order to finish the proof of Theorem 10.6.20 it suffices to identify the equivalence relation \approx .

The relations of Lemmas 10.6.14 and 10.6.15 imply that $\underline{a} - \iota \circ \psi(\underline{a})$ is in the image of $\pi \circ d$ for any \underline{a} in $A^{\otimes n}$. In other words, in $A^{\otimes n}/\approx$, one has

$$(a_1, \dots, a_n) = \text{sgn}(\omega)(a_{\omega(1)}, \dots, a_{\omega(n)})$$

for any $\omega \in S_n$ such that $\omega(1) = 1$.

Consequently $A^{\otimes n}/\approx$ is a quotient of $A \otimes A^{n-1}A$. The rest of the proof is exactly as in 10.3.6. □

The end of this section deals with $HL_*(gl_r(A))$ for fixed r .

10.6.22 Conjecture. Let A be a commutative and unital algebra over a characteristic zero field k . Then for any positive integer r there is a canonical isomorphism

$$HL_*(gl_r(A)) \cong T\left(\bigoplus_{i < r} HH_{*-1}^{(i)}(A)\right),$$

where $HH_* = \bigoplus_i HH_*^{(i)}$ is the λ -decomposition of Hochschild homology (cf. 4.5.10).

10.6.23 Comments on the Conjecture. As in the gl -case this conjecture may be too optimistic. Again it is consistent with all the results of this section and of Sect. 4.5.

The particular case $A = k$ has recently been proved by C. Cuvier [unpublished] under the form

$$HL_n(sl_r(k)) = 0 \quad \text{for } n > 0 \quad \text{and any } r \geq 2.$$

More generally one should have, for any semi-simple Lie algebra \mathfrak{g} over k ,

$$HL_n(\mathfrak{g}) = 0 \quad \text{for } n > 0.$$

Exercises

E.10.6.1. Show that for any Leibniz algebra \mathfrak{g} one has

$$HL_*(\mathfrak{g}, \mathfrak{g}) \cong HL_{*+1}(\mathfrak{g}, k)$$

where \mathfrak{g} is a module over itself via the bracket (Compare with Exercise E.10.4.3).

E.10.6.2. Show that there is defined a cohomology theory $HL^*(\mathfrak{g}, M)$ dual to HL_* . Give interpretation of the groups HL^1, HL^2, HL^3 in terms of crossed homomorphisms, extensions, and crossed modules of Leibniz algebras respectively. (Cf. C. Cuvier [thèse, to appear] and Loday-Pirashvili [1992].)

E.10.6.3. Show that the tensor product of matrices induces a product on $HL_*(gl(A))$ whose restriction to the primitive part coincides with the shuffle product on Hochschild homology.

E.10.6.4. Show that the exterior product of matrices permits us to define λ -operations on $HL_*(gl(A))$. Show that their restriction to the primitive part coincides with the λ -operations on Hochschild homology.

E.10.6.5. Compute $HL_*(o(A))$ and $HL_*(sp(A))$.

E.10.6.6. Let Γ^{op} be the category Δ^{op} enriched with morphisms $s_{-1} : [n] \rightarrow [n + 1]$ for each n , satisfying,

$$\begin{aligned} s_{-1}s_j &= s_{j+1}s_{-1} \quad \text{for } j \geq 0, \\ d_i s_{-1} &= s_{-1}d_{i-1} \quad \text{for } 0 < i \leq n, \\ d_0 s_{-1} &= id, \\ (d_{n+1}s_{-1})^{n+1} &\text{ is an idempotent.} \end{aligned}$$

- (a) Show that ΔC^{op} admits a similar presentation with the last relation replaced by $(d_{n+1}s_{-1})^{n+1} = id_n$. Whence a functor $\Gamma^{\text{op}} \rightarrow \Delta C^{\text{op}}$.
- (b) Let M be a Γ^{op} -module and let $N_n = \text{Im}(d_{n+1}s_{-1})^{n+1}$. Show that N is a simplicial module, and that the inclusion from N into M induces an isomorphism on homology. (Compare with Proposition 6.1.11. For (d) apply the technique used in the fourth step of the proof of 10.6.5: $bB + Bb = id - t^{n+1}$.)

E.10.6.7. Let A be an associative algebra and $D : A \rightarrow A$ be a k -linear map such that $D(a Db) = Da Db = D(Da b)$, e.g. $D = id$ or D is a square-zero derivation. Show that the bracket

$$[x, y] := x Dy - Dy x$$

satisfies the Leibniz relation.

Bibliographical Comments on Chapter 10

The classical reference for the basics on homology and cohomology of Lie algebras is Koszul [1950]. The main theorem about the relationship to cyclic homology was announced in Loday-Quillen [1983] and published (with more material) in [LQ]. It was also proved independently by Tsygan, see Tsygan [1983] for the announcement and [FT] for the proof. A similar proof for the particular case of a tensor algebra is hinted in Dwyer-Hsiang-Staffeldt [1980] and Hsiang-Staffeldt [1982].

The stability and the computation of the obstruction to stability is in [LQ]. The case of the adjoint representation (same technique of proof) is in Goodwillie [1985b], the orthogonal and symplectic cases are in Loday-Procesi [1988]. All these cases are also treated in [FT]. Extension of the L-Q-T result to non-unital algebras is dealt with in Hanlon [1988].

The theory of non-commutative homology of Lie algebras is new. The crucial step permitting the comparison with Hochschild homology is due to C. Cuvier [1991] as indicated. Interpretation of HL in terms of derived functors and more results can be found in Loday-Pirashvili [1992].

The computations of this chapter are all in characteristic zero. In positive characteristic the right framework is the category of “restricted p -Lie algebras”. For a first result in this direction, see Aboughazi [1989]. The conjectures 10.3.9 (resp. 10.6.22) about the computation of $H_*(gl_r(A))$ (resp. $HL_*(gl_r(A))$) for a fixed integer r , are analogous to similar conjectures about $H_*(GL_r(A))$ (see 11.2.18.4), which grew out from discussions that I had with Christophe Soulé a long time ago. Different proofs of the computation of $HL_*(gl(A))$ can be found in Lodder [1995], Oudom [1997] and Frabetti [1997].

Chapter 11. Algebraic K -Theory

The Grothendieck group $K_0(A)$ of a ring A was introduced in the sixties by Grothendieck in order to give a nice formulation of the Riemann-Roch theorem. Then it was recognized that the Grothendieck group is closely related to the abelianization $K_1(A)$ of the general linear group, which had been studied earlier (1949) by J.H.C. Whitehead in his work on simple homotopy. The next step was the discovery of the K_2 -group by Milnor in his attempt to understand the Steinberg symbols in arithmetic. At that point these three groups were expected to be part of a family of algebraic K -functors K_n defined for all $n \geq 0$. After several attempts by different people, Quillen came with a simple construction, the so-called plus-construction, which gives rise to higher algebraic K -theory.

These K -groups are related to the general linear group in the same way as additive K -theory (i.e. cyclic homology) is related to the Lie algebra of matrices. Therefore it is not surprising that, in a framework where exponential and logarithm maps exist, these two theories are related to one another. Two cases arise naturally, the relative case with nilpotent ideal, and the topological case of Banach algebras. Both cases permit us to do calculations of algebraic K -groups using cyclic homology.

In this short introduction to algebraic K -theory we essentially define and study whatever is necessary to understand the relationship with cyclic homology. Note that the Grothendieck group K_0 has been dealt with in Sect. 8.2.

Section 11.1 begins with the Bass-Whitehead group K_1 and the Milnor group K_2 . It is shown how they are related to GL , to the subgroup E of elementary matrices and to the Steinberg group St .

Section 11.2 introduces the plus-construction of Quillen and the definition $K_n(A) := \pi_n(BGL(A)^+)$ for any ring A and any $n \geq 1$. It is shown that this definition agrees with the former ones for $n = 1$ and $n = 2$. For $n = 3$ it is interpreted in terms of the homology of the Steinberg group. One of the main properties of the K -groups, that we are going to use later on, is their identification with the primitive part of $H_*(GL(A))$ rationally.

Section 11.3 is devoted to Goodwillie's isomorphism between relative algebraic K -theory and relative cyclic homology of a nilpotent ideal in characteristic zero,

$$\varrho : K_n(A, I)_{\mathbb{Q}} \cong HC_{n-1}(A, I)_{\mathbb{Q}}, \quad n \geq 1.$$

In Sect. 11.4 we use the results of Chap. 8 to construct Chern character maps from algebraic K -theory to cyclic homology, both for rings (absolute case) and for ideals (relative case). The relative Chern character is compared with Goodwillie's isomorphism.

Section 11.5 handles the case of Banach algebras and it is shown that these Chern characters give rise to secondary characteristic classes. The particular case of the ring of integers in a number field gives rise to the regulator map.

This chapter relies heavily on elementary algebraic topology. We assume familiarity with classical notions and theorems such as the Hurewicz theorem, the Mayer-Vietoris sequence, the J.H.C. Whitehead's theorem, simple spaces, homotopy fibrations and their homology spectral sequence, obstruction theory, see for instance G.W. Whitehead [1978].

At some places we refer to the literature for the proof. In particular the last section is proofless.

Standing Assumptions and Notation. All topological spaces are of the homotopy type of CW -complexes and are base-pointed (unless otherwise explicitly stated). Localization of an abelian group over the rationals is denoted either by $(-)_\mathbb{Q}$ or by $(-) \otimes \mathbb{Q}$.

11.1 The Bass-Whitehead Group K_1 and the Milnor Group K_2

In this section we give a brief outline of the functors K_1 and K_2 . Details and more properties are to be found in Bass [1968], Milnor [1974] and subsequent articles (see Magurn [1984]). Among the main properties of these groups is their relationship with the homology of $GL(A)$ and of the elementary group $E(A)$. In fact the equalities

$$K_1(A) = H_1(GL(A), \mathbb{Z}) \quad \text{and} \quad K_2(A) = H_2(E(A), \mathbb{Z})$$

can be taken as definitions (compare with Exercise E.10.2.5).

11.1.1 Definition of the Bass-Whitehead Group K_1 . Let $GL_n(A)$ be the general linear group of $n \times n$ matrices with coefficients in A . It is made of invertible $n \times n$ matrices and the group law is the multiplication of matrices. The inclusion $GL_n(A) \hookrightarrow GL_{n+1}(A)$ consists in bordering by 0's and 1,

$$\alpha \mapsto \begin{bmatrix} & & 0 \\ & \alpha & \cdot \\ 0 & \dots & 0 & 1 \end{bmatrix}$$

The inductive limit $\lim_n GL_n(A) = \cup_n GL_n(A)$ is denoted by $GL_\infty(A)$ or, more often, by $GL(A)$.

By definition the *commutator* of x and y in a group G is the element $[x, y] := xyx^{-1}y^{-1}$. The normal subgroup of G generated by these commutators is the *commutator subgroup* of G , denoted $[G, G]$. Obviously the quotient $G/[G, G]$ is abelian, and in fact universal for this property. It is sometimes denoted G_{ab} .

By definition the *Bass-Whitehead group* of the ring A is

$$K_1(A) := GL(A)/[GL(A), GL(A)] .$$

This defines a functor K_1 from the category of rings to the category of abelian groups.

Note that for any discrete group G one has $G_{\text{ab}} = H_1(G, \mathbb{Z})$ (cf. Appendix C.2).

So one has

$$(11.1.1.1) \quad K_1(A) = H_1(GL(A), \mathbb{Z}) .$$

11.1.2 The Determinant and SK_1 . In this subsection the ring A is commutative. For any n the determinant $\det(\alpha)$ of the invertible matrix $\alpha \in GL_n(A)$ is an invertible element of A . Clearly the inclusion map described in 11.1.1 commutes with the determinant (because $\det(\alpha \oplus \beta) = \det(\alpha) \det(\beta)$ and $\det(1) = 1$) and so $\det : GL(A) \rightarrow A^\times$ is a well-defined group homomorphism with values in the abelian group of invertible elements of A . Since for any matrices α and β one has $\det(\alpha\beta) = \det(\beta\alpha)$ it follows that the determinant map factors through $GL(A)_{\text{ab}} = K_1(A)$ to give

$$\det : K_1(A) \rightarrow A^\times .$$

From $A^\times = GL_1(A)$ and from $\det(a) = a$ for any $a \in A^\times$ it is easily seen that \det is canonically split. By definition one puts $SK_1(A) := \text{Ker}(\det)$ so that $K_1(A) = SK_1(A) \oplus A^\times$.

11.1.3 First Properties and Computations of K_1 . In this subsection we mention without proof some results on K_1 . Here are some examples for which $K_1(A) = A^\times$, that is $SK_1(A) = 0$:

- A is a field or, more generally, A is a local ring,
- $A = \mathbb{Z}$ or, more generally, A is an Euclidean ring,
- A is the ring of integers in a finite extension of \mathbb{Q} .

However there are many examples for which $SK_1(A) \neq 0$ and there are many articles devoted to the computation of $SK_1(A)$ (cf. Magurn [1984]). Let $A = \mathbb{R}[x, y]/(x^2 + y^2 = 1)$ and let

$$\alpha = \begin{bmatrix} x & y \\ -y & x \end{bmatrix} \in GL_2(A) .$$

Since $\det(\alpha) = 1$, the class of α is an element of $SK_1(A)$. It can be shown to generate an infinite cyclic subgroup.

Let $A[t, t^{-1}]$ be the Laurent polynomial ring over the ring A . Then the map

$$e \mapsto et + (1 - e),$$

where e is an idempotent in $\mathcal{M}(A)$ defines a map

$$(11.1.3.1) \quad K_0(A) \rightarrow K_1(A[t, t^{-1}])$$

which can be shown to be split injective.

11.1.4 The Group $E(A)$ of Elementary Matrices. Let $e_{ij}(a)$, $i \neq j$, $i \geq 1$, $j \geq 1$, be the so-called *elementary matrix* whose coefficients are 1 in the diagonal, $a \in A$ in the row i and the column j , and 0 otherwise:

$$e_{ij}(a) = \begin{bmatrix} 1 & & & \\ & 1 & & a \\ & & \dots & \\ & & & 1 \end{bmatrix}.$$

The normal subgroup of $GL(A)$ generated by the elementary matrices is the *elementary group* $E(A)$. It has the following properties.

11.1.5 Proposition. *For any ring A one has*

$$[GL(A), GL(A)] = E(A) = [E(A), E(A)].$$

Proof. The proposition follows from the inclusions

$$E(A) \subset [E(A), E(A)] \subset [GL(A), GL(A)] \subset E(A).$$

The first inclusion is a consequence of the following formula which is valid for any $a \in A$ and any set of indices i, j, k such that $i \neq j \neq k \neq i$,

$$e_{ij}(a) = [e_{ik}(a), e_{kj}(1)].$$

The second inclusion is obvious since $E(A) \subset GL(A)$. Let us show the last inclusion. For any finite dimensional (and invertible) matrix x we identify it with its image in $GL(A)$. Let y be another one. Then in $GL(A)$ one has the equality

$$[x, y] = \left[\begin{pmatrix} x & & \\ & x^{-1} & \\ & & 1 \end{pmatrix}, \begin{pmatrix} y & & \\ & 1 & \\ & & y^{-1} \end{pmatrix} \right].$$

Therefore it suffices to show that for any x the matrix

$$\begin{bmatrix} x & \\ & x^{-1} \end{bmatrix}$$

is in $E(A)$. This is an immediate consequence of the next

11.1.6 Lemma (Whitehead Identity). *For any finite dimensional invertible matrix x the matrix*

$$w(x) := \begin{bmatrix} & x \\ -x^{-1} & \end{bmatrix}$$

satisfies the following identities:

$$w(x)w(-1) = \begin{bmatrix} x & \\ & x^{-1} \end{bmatrix},$$

$$w(x) = \begin{bmatrix} 1 & x \\ 0 & 1 \end{bmatrix} \begin{bmatrix} 1 & 0 \\ -x^{-1} & 1 \end{bmatrix} \begin{bmatrix} 1 & x \\ 0 & 1 \end{bmatrix} \in E(A).$$

Proof. Both of these formulas are immediate to verify by direct computation. One has $w(x) \in E(A)$ since the matrix

$$\begin{bmatrix} 1 & x \\ 0 & 1 \end{bmatrix}$$

is the product of the elementary matrices $e_{i,j+n}(x_{ij})$, when x is of dimension n . □

(11.1.6.1) Note that a group G is said to be *perfect* if $G = [G, G]$. So by Lemma 11.1.6 the elementary group $E(A)$ is perfect.

11.1.7 The Steinberg Group. By definition the *Steinberg group* $St(A)$ of the ring A is presented by generators $x_{ij}(a)$, $i \geq 1, j \geq 1, i \neq j, a \in A$ and relations

- (a) $x_{ij}(a)x_{ij}(b) = x_{ij}(a + b)$,
- (b) $[x_{ij}(a), x_{kl}(b)] = 1, j \neq k, i \neq l$,
- (c) $[x_{ij}(a), x_{jk}(b)] = x_{ik}(ab)$.

Obviously St is a functor from the category of rings to the category of groups. From the well-known relations satisfied by the elementary matrices, we see that there is a natural epimorphism

$$\phi : St(A) \rightarrow E(A), \quad \phi(x_{ij}(a)) = e_{ij}(a).$$

11.1.8 Proposition. *The Steinberg group $St(A)$ and the epimorphism ϕ determine a central extension of the elementary group $E(A)$.*

Proof. Cf. Milnor [1974, p. 47]. □

11.1.9 Corollary. *Ker ϕ is equal to the center of $St(A)$.*

Proof. For any element x in the center of $St(A)$, $\phi(x)$ is in the center of $E(A)$. But clearly center $E(A) = 1$ and so $\phi(x) = 1$ and center $St(A) \subset \text{Ker } \phi$. The other inclusion is given by Proposition 11.1.8. □

11.1.10 Definition of the Group K_2 (Milnor). The group $K_2(A)$ of the ring A is by definition

$$K_2(A) := \text{Ker}(\phi : St(A) \rightarrow E(A)) ,$$

where ϕ is the central extension described in 11.1.7. By Proposition 11.1.8 the group $K_2(A)$ is abelian. In fact K_2 is a functor from the category of rings to the category of abelian groups.

It is beyond the scope of this book to make any computation of K_2 . Let us just mention that $K_2(\mathbb{Z}) \cong \mathbb{Z}/2\mathbb{Z}$ with generator $w(1)^4 \in St(\mathbb{Z})$ (notation of Lemma 11.1.6, see 11.1.15). Later we will give more information on K_2 of a field, of a local ring and of Laurent polynomials. But before that we give an interpretation of K_2 in terms of group homology.

11.1.11 Universal Central Extensions of Groups. Let us recall a few facts about the cohomological group $H^2(G, H_2(G))$, when G is a perfect group. By the universal coefficient theorem (cf. 1.0.7), there is an isomorphism $H^2(G, H_2(G)) \cong \text{Hom}(H_2(G), H_2(G))$. Since $H^2(G, H_2(G))$ classifies the central extensions of $H_2(G)$ by G (cf. Appendix C.7), there is an extension, well-defined up to isomorphism, which corresponds to $id_{H_2(G)}$. It is called the *universal central extension* of G ,

$$0 \rightarrow H_2(G) \rightarrow \tilde{G} \rightarrow G \rightarrow 1 ,$$

because, for any other central extension Γ of G , there is a unique map from \tilde{G} to Γ over G . The induced map $H_2(G) \rightarrow \text{Ker } \psi$ corresponds to the cohomology class of the extension Γ via the isomorphism $\text{Hom}(H_2G, \text{Ker } \psi) \cong H^2(G, \text{Ker } \psi)$.

11.1.12 Theorem (Kervaire). *The extension*

$$1 \rightarrow K_2(A) \rightarrow St(A) \rightarrow E(A) \rightarrow 1 ,$$

is the universal central extension of the perfect group $E(A)$. Therefore there is a canonical isomorphism

$$K_2(A) \cong H_2(E(A), \mathbb{Z}) .$$

Proof. Cf. Kervaire [1970] or Milnor [1974]. □

11.1.13 The Product Map $K_1 \times K_1 \rightarrow K_2$. One can define an “exterior” product $K_1(A) \times K_1(A') \rightarrow K_2(A \otimes A')$ and, as usual, for A commutative an “interior” product $K_1(A) \times K_1(A) \rightarrow K_2(A)$ which is the exterior product for $A = A'$ composed with the map induced by the product in A . We will only deal with the interior product for sake of simplicity.

Let $\alpha \in GL_n(A)$ and $\beta \in GL_m(A)$. After choosing an isomorphism of A^{nm} with $A^n \otimes A^m$ there are defined elements $\alpha \otimes 1_m$ and $1_n \otimes \beta$ in $GL_{nm}(A)$ which happen to commute. Consider the following elements of $GL_{3nm}(A)$,

$$D(\alpha) = \begin{bmatrix} \alpha \otimes 1_m & & \\ & \alpha^{-1} \otimes 1_m & \\ & & 1_n \otimes 1_m \end{bmatrix} \quad \text{and}$$

$$D'(\beta) = \begin{bmatrix} 1_n \otimes \beta & & \\ & 1_n \otimes 1_m & \\ & & 1_n \otimes \beta^{-1} \end{bmatrix}$$

By Lemma 11.1.6 they belong to $E_{3nm}(A) \subset E(A)$. Choose liftings $\tilde{D}(\alpha)$ and $\tilde{D}'(\beta)$ of these elements in $St(A)$. Since $D(\alpha) = \phi(\tilde{D}(\alpha))$ and $D'(\beta) = \phi(\tilde{D}'(\beta))$ commute in $E(A)$, the commutator $[\tilde{D}(\alpha), \tilde{D}'(\beta)]$ belongs to $\text{Ker } \phi = K_2(A)$. This commutator does not depend on the choice of the liftings and depends only on the class $[\alpha]$ of α in $K_1(A)$ and on the class $[\beta]$ of β in $K_1(A)$. So we have proved the first part of the following

11.1.14 Proposition. *The assignment $([\alpha], [\beta]) \mapsto [\tilde{D}(\alpha), \tilde{D}'(\beta)]$ is a well-defined bilinear map called the “cup-product”*

$$\cup : K_1(A) \times K_1(A) \rightarrow K_2(A) ,$$

which is graded commutative ($x \cup y = -y \cup x$).

Proof. Linearity on the left-hand factor follows from the commutator identity

$$[xx', y] = [x, [x', y]][x', y][x, y]$$

applied in the case where $[x', y]$ is central. The graded commutativity is a consequence of the commutator identity $[x, y] = [y, x]^{-1}$ and the fact that $K_2(A)$ is central in $St(A)$, hence invariant by conjugation. \square

11.1.15 Steinberg Symbols and K_2 of Fields. Let A be commutative and let x and y be invertible elements in A . They determine elements still denoted x and y in $K_1(A)$ and their cup-product $x \cup y \in K_2(A)$ (sometimes denoted $\{x, y\}$) is called a *Steinberg symbol*. Besides the bilinearity property and the graded commutativity mentioned in Proposition 11.1.14 these elements satisfy the following identities (cf. Milnor [1974, §9]),

$$(11.1.15.1) \quad x \cup (1 - x) = 1 \quad (\text{Steinberg relation}) ,$$

$$(11.1.15.2) \quad x \cup -x = 1 ,$$

where 1 is the neutral element of $K_2(A) \subset St(A)$.

For any commutative ring A the *Milnor K -group* of A , denoted $K_2^M(A)$ is an abelian group defined by generators and relations as follows (we use a multiplicative notation). The generators are $\{x, y\}$ where x and y are invertible elements in A . The relations are

- (1) $\{xx', y\} = \{x, y\}\{x', y\}$,
- (2) $\{x, y\}\{y, x\} = 1$,
- (3) $\{x, 1 - x\} = 1$,
- (4) $\{x, -x\} = 1$.

From the properties of the K_2 -group it is immediate that there is a natural map

$$K_2^M(A) \rightarrow K_2(A), \{x, y\} \mapsto x \cup y.$$

The computation of $K_2(\mathbb{Z})$ mentioned in 11.1.10 is such that $K_2^M(\mathbb{Z}) \cong K_2(\mathbb{Z}) \cong \mathbb{Z}/2\mathbb{Z}$ with generator $\{-1, -1\}$. A fundamental result in this area is the so-called *Matsumoto's theorem* which asserts that

(11.1.15.3)

if F is a field, then $K_2^M(F) \rightarrow K_2(F)$ is an isomorphism.

As mentioned before this theorem is still true for $F = \mathbb{Z}$. We refer to Milnor [1974] for a proof of these assertions.

11.1.16 Milnor K -Groups. Let A be a commutative ring and consider the tensor algebra $T(A^\times)$ over \mathbb{Z} where A^\times is the abelian group of invertible elements of A . For any $x \in A^\times - \{1\}$ the elements $x \otimes (1 - x)$ and $x \otimes (-x)$ generate a 2-sided ideal I of $T(A^\times)$ and we consider the quotient $T(A^\times)/I$. It is a graded abelian group whose components in degree 0, 1 and 2 are respectively \mathbb{Z} , A^\times , $K_2^M(A)$. By definition the n th graded piece is called the *n th Milnor K -group* of A and denoted $K_n^M(A)$.

These groups have been extensively studied for $A = F$ being a field. In this case the relation (4) in 11.1.15 is a consequence of the others.

Exercises

E.11.1.1. Dennis-Stein Symbols. For any ring A define elements of $St(A)$, for any $a, b \in A$ such that $1 - ab$ is invertible, as follows,

$$H_{12}(a, b) := x_{21}^{-b(1-ab)^{-1}} x_{12}^{-a} x_{21}^b x_{12}^{(1-ab)^{-1}a} \quad \text{and} \\ \langle a, b \rangle := H_{12}(a, b)H_{12}(ab, 1)^{-1}.$$

Show that the elements $\langle a, b \rangle$ are in $K_2(A)$ and satisfy the following relations,

- (1) $\langle 1, c \rangle = 0, \quad c \in A$,
- (2) $\langle a, b \rangle + \langle a', b \rangle = \langle a + a' - aba', b \rangle, \quad a, a', b \in A$,
- (3) $\langle ab, c \rangle - \langle a, bc \rangle + \langle ca, b \rangle = 0, \quad a, b, c \in A$.

Show that if b is invertible, then $\langle a, b \rangle = \{1 - ab, b\}$. Show that if A is a local ring (for instance a field), then the generators $\langle a, b \rangle$ and the relations (1), (2)

and (3) form a presentation of $K_2(A)$ (cf. Dennis-Stein [1973] and van der Kallen-Maazen-Stienstra [1975]).

E.11.1.2. Relative K -Groups. For any 2-sided ideal I of the ring A show that there exist functorial groups $K_0(A, I)$, $K_1(A, I)$ and $K_2(A, I)$ which fit into a long exact sequence

$$\begin{aligned} K_3(A) \rightarrow K_3(A/I) \rightarrow K_2(A, I) \rightarrow K_2(A) \rightarrow K_2(A/I) \rightarrow K_1(A, I) \\ \rightarrow K_1(A) \rightarrow K_1(A/I) \rightarrow K_0(A, I) \rightarrow K_0(A) \rightarrow K_0(A/I), \end{aligned}$$

where $K_3(A) = H_3(St(A), \mathbb{Z})$ (cf. Bass [1968], Milnor [1974] and Loday [1978]).

E.11.1.3. Relative K_2 . Let A be a commutative ring and I an ideal of A , which is in the Jacobson radical of A . Show that $K_2(A, I)$ is isomorphic to the group $K_2^{DS}(A, I)$ generated by the symbols $\langle a, b \rangle$, $a, b \in A$ and either a or b is in I , with the relations of Exercise E.11.1.1, where in relation (1) c is in I , in relation (2) b is in I or a and a' are in I , in relation (3) either a or b or c is in I (cf. Keune [1978]).

E.11.1.4. Dieudonné Determinant. Show that for any ring A there is a natural map $K_1(A) \rightarrow A^\times/[A^\times, A^\times]$ which coincides with the determinant map in the commutative case.

11.2 Higher Algebraic K -Theory

Quillen's plus-construction is a modification of a space obtained by adding a few cells so that a perfect subgroup of the fundamental group is killed, though the homology of the space remains unchanged. The point is that the higher homotopy groups of the new space differ radically from those of the former one. Applied to the classifying space $BGL(A)$ of the discrete group $GL(A)$, one obtains a new space $BGL(A)^+$ whose homotopy groups are, by definition, the algebraic K -groups $K_n(A)$. Other definitions (for instance Quillen's categorical Q -construction [1973a]), more suitable to derive some properties of the K -groups, are beyond the scope of this book.

First, we show that this definition of the K -groups agrees with the previous ones in low dimensions, and we interpret K_3 in terms of the homology of the Steinberg group. One of the main relations with the general linear group is the identification of K_n with the primitive part of $H_n(GL(A))$ rationally (cf. 11.2.18). Another one is given by the stabilization theorems of Suslin (11.2.16).

Then we introduce the Volodin construction of the K -groups, whose relative version is going to play an important role in the comparison with relative cyclic homology (Sect. 11.3).

We construct the natural product in algebraic K -theory out of the tensor product of matrices and show how it relates the Milnor K -groups to the Quillen K -groups. We end this section with the definition of relative and birelative K -groups and some computations.

Standing Assumptions. All spaces are supposed to be of the homotopy type of CW -complexes. In this section A is a ring.

11.2.1 Quillen's Plus-construction. Recall that a group N is said to be *perfect* if it is equal to its own commutator subgroup, $N = [N, N]$, equivalently $N_{ab} = 1$. We first describe the plus-construction of Quillen in the case where the fundamental group is perfect. The generalization is given in 11.2.3.

11.2.2 Theorem (Quillen). *Let X be a connected basepointed space whose fundamental group $\pi_1(X)$ is perfect. Then there exists a connected pointed space X^+ and a pointed continuous map $i : X \rightarrow X^+$ such that*

- (i) $\pi_1(X^+) = 1$,
- (ii) *the map i induces an isomorphism in homology*

$$i_* : H_*(X, \mathbb{Z}) \rightarrow H_*(X^+, \mathbb{Z}) .$$

The map i is universal up to homotopy for the maps $f : X \rightarrow Y$ such that $f_(\pi_1(X)) = 1$.*

Note that, by the universality property and obstruction theory, the space X^+ is unique up to homotopy.

Proof. Let $f_i : S^1 \rightarrow X$, $i \in I$, be a set of basepoint preserving maps such that the homotopy classes $[f_i]$ generate $\pi_1(X)$. We use these maps to glue 2-cells e_i^2 to X by making the amalgamated sum $X_1 = X \cup \cup_{i \in I} e_i^2$. The space X_1 is obviously simply connected (Van Kampen theorem) and therefore the Hurewicz map $h : \pi_2(X_1) \rightarrow H_2(X_1)$ is an isomorphism.

Consider the following commutative diagram of homotopy and homology exact sequences associated to the cofibration $X \hookrightarrow X_1$, where the vertical maps are the Hurewicz homomorphisms,

$$\begin{array}{ccccc} \pi_2(X_1) & \rightarrow & \pi_2(X_1, X) & \rightarrow & \pi_1(X) \\ h \downarrow & & \downarrow & & \downarrow \\ H_2(X_1) & \xrightarrow{j} & H_2(X_1, X) & \rightarrow & H_1(X) = 0 . \end{array}$$

We have $H_1(X) = 0$ because $H_1(X) = \pi_1(X)_{ab}$ and $\pi_1(X)$ is perfect by hypothesis. Therefore j is a surjective map. By construction the relative homology group (with \mathbb{Z} coefficients) $H_2(X_1, X)$ is a free abelian group generated by (e_i^2) , $i \in I$. Choose maps $b_i : S^2 \rightarrow X_1$ such that $j \circ h[b_i] = (e_i^2)$. This is possible since j is surjective and since h is an isomorphism. Using the maps b_i , we

glue 3-cells $(e_i^3), i \in I$, to X_1 to get the amalgamated sum $X^+ = X_1 \cup_{i \in I} e_i^3$. It is immediate to see that $\pi_1(X^+)$ is trivial (Van Kampen theorem), and so the first condition is fulfilled. To show that the cofibration $i : X \rightarrow X^+$ induces an isomorphism in homology (second condition) it suffices to show that the relative homology groups $H_*(X^+, X)$ are trivial.

The chain complex $C_*(X^+, X)$ which computes this relative homology takes the following form,

$$\dots \rightarrow 0 \rightarrow C_3(X^+, X) \xrightarrow{d} C_2(X^+, X) \rightarrow 0 \dots,$$

where $C_3(X^+, X)$ (resp. $C_2(X^+, X)$) is a free abelian group generated by the classes $(e_i^3), i \in I$, (resp. $(e_i^2), i \in I$). Therefore it is sufficient to prove that $d(e_i^3) = (e_i^2)$. By construction the boundary of (e_i^3) is the image of the map b_i , and this image is

$$j \circ h[b_i] = (e_i^2) \in H_2(X_1, X) = C_2(X_1, X) = C_2(X^+, X).$$

So the complex $C_*(X^+, X)$ is acyclic and we are done.

In order to prove the universality of the plus-construction one needs to show that for any $f : X \rightarrow Y$ such that $f_*(\pi_1(X)) = 0$, there exists an extension $f^+ : X^+ \rightarrow Y$ such that $f^+ \circ i$ is homotopic to f . Then one needs to show that two such extensions are homotopic. These are classical problems in obstruction theory. All the obstructions are trivial because they belong to the relative cohomology groups $H^*(X^+, X)$ which are trivial by construction. The details are left to the reader (cf. for instance Loday [1976]). \square

11.2.3 Corollary. *Let X be a connected CW-complex and let N be a normal perfect subgroup of $\pi_1(X)$. Then there exists a space X^+ (depending on N) and a map $i : X \rightarrow X^+$ such that*

- (i) $i_* : \pi_1(X) \rightarrow \pi_1(X^+)$ is the surjection $\pi_1(X) \twoheadrightarrow \pi_1(X)/N$,
- (ii) for any $\pi_1(X^+)/N$ -module L there is an isomorphism in homology

$$i_* : H_*(X, i^*L) \rightarrow H_*(X^+, L),$$

where i^*L is L considered as a $\pi_1(X)$ -module.

The map i is universal up to homotopy for the maps $f : X \rightarrow Y$ such that $\pi_1(f)(N) = 1$.

Proof. Let $Z \rightarrow X$ be the covering associated to the surjection $\pi_1(X) \twoheadrightarrow \pi_1(X)/N$. Since $\pi_1(Z) = N$ is perfect one can apply the plus-construction to the space Z . The space X^+ is defined to be the amalgamated sum in the following pushout diagram

$$\begin{array}{ccc} Z & \longrightarrow & Z^+ \\ \downarrow & & \downarrow \\ X & \longrightarrow & X^+. \end{array}$$

Property (i) follows from the Van Kampen theorem and property (i) of Theorem 11.2.2. Property (ii) follows from excision property for a pushout diagram and property (ii) of Theorem 11.2.2. \square

11.2.4 Higher Algebraic K -Groups. Let A be a ring and let $GL(A)$ be the general linear group of $A (= \cup_n GL_n(A))$. Consider the classifying space $BGL(A)$ of the discrete group $GL(A)$. Its fundamental group contains $E(A)$ as a normal subgroup (cf. 11.1.5). The plus-construction applied to $BGL(A)$ with respect to $E(A)$ gives the space $BGL(A)^+$. By definition the *Quillen K -groups* (or simply K -groups) of A are

$$K_n(A) := \pi_n(BGL(A)^+), \quad n \geq 1.$$

We will see below that this definition coincides with K_1 and K_2 as constructed before.

It is not immediate a priori that this definition gives functors K_n from the category of rings to the category of abelian groups because the plus-construction requires choices. Different choices give different spaces (or “models”) but homotopy equivalent ones. Since we are only interested in the homotopy type we adopt the same notation X^+ whatever the choices are. There are several ways to prove this naturality property. One of them is the following. Fix choices to construct $BE(\mathbb{Z})^+$. Then define $BGL(A)^+$ by the following push-out diagram,

$$\begin{array}{ccc} BE(\mathbb{Z}) & \longrightarrow & BE(\mathbb{Z})^+ \\ \downarrow & & \downarrow \\ BGL(A) & \longrightarrow & BGL(A)^+ \end{array}$$

involving the natural map $\mathbb{Z} \rightarrow A$ (remember that A has a unit). This makes the space $BGL(A)^+$, and therefore $K_n(A)$, functorial in A (see 11.2.11 and 11.2.13 for other methods).

11.2.5 The Groups K_1, K_2, K_3 . From the property of the plus-construction (cf. 11.2.3) and Proposition 11.1.5 one has

$$\pi_1(BGL(A)^+) = GL(A)/E(A) = GL(A)_{ab}.$$

Therefore, in dimension 1, Quillen’s definition coincides with the Bass-Whitehead definition.

One can also apply the plus-construction to the classifying space $BE(A)$ since its fundamental group $E(A)$ is perfect. It turns out that $BE(A)^+$ is the universal cover of $BGL(A)^+$ (because $BE(A)$ is the covering of $BGL(A)$ with respect to the subgroup $E(A)$ of $GL(A)$). So the natural map $BE(A)^+ \rightarrow BGL(A)^+$ induces an isomorphism on the homotopy groups π_n for $n \geq 2$. In particular there are natural isomorphisms

$$K_2(A) = \pi_2(BGL(A)^+) \stackrel{1}{\cong} \pi_2(BE(A)^+) \stackrel{2}{\cong} H_2(BE(A)^+) \stackrel{3}{\cong} H_2(BE(A)) = H_2(E(A)),$$

where isomorphism 2 is the Hurewicz homomorphism, which is an isomorphism since $BE(A)^+$ is simply connected, and where isomorphism 3 is the fundamental isomorphism given by the plus-construction (Theorem 11.2.2.ii).

By Theorem 11.1.12 this shows that Quillen’s definition for K_2 coincides with Milnor’s definition.

In order to interpret K_3 in homological terms, one needs to bring in the Steinberg group $St(A)$. The exact sequence of Theorem 11.1.12 gives the following

11.2.6 Proposition. *For any ring A there is a homotopy fibration*

$$BK_2(A) \rightarrow BSt(A)^+ \rightarrow BE(A)^+.$$

Sketch of the Proof. We apply the homology spectral sequence comparison theorem (cf. Appendix D) to the following diagram of horizontal fibrations

$$\begin{array}{ccccc} BK_2(A) & \rightarrow & BSt(A) & \rightarrow & BE(A) \\ \downarrow & & \downarrow & & \downarrow \\ F & \rightarrow & BSt(A)^+ & \rightarrow & BE(A)^+. \end{array}$$

The base and total space maps induce isomorphisms in homology. In both fibrations the fundamental group of the base acts trivially on the fiber. Therefore the fiber map induces an isomorphism in homology. Since both fibers are simple, they are homotopy equivalent by Whitehead’s theorem. See Loday [1976] for more details. \square

11.2.7 Corollary (S.M. Gersten). *For any ring A there is a canonical isomorphism*

$$K_3(A) \cong H_3(St(A)).$$

Proof. From the fibration of Proposition 11.2.6 and the isomorphism $K_2(A) \cong H_2(BE(A)^+)$ one sees that $BSt(A)^+$ is 2-connected (and so $H_1(St(A)) = H_2(St(A)) = 0$). As a consequence there are natural isomorphisms

$$\begin{aligned} K_3(A) &= \pi_3(BGL(A)^+) \cong \pi_3(BE(A)^+) \cong \pi_3(BSt(A)^+) \\ &\cong H_3(BSt(A)^+) \cong H_3(BSt(A)) = H_3(St(A)). \end{aligned} \quad \square$$

This result has to be compared with its Lie analogue dealt with in Exercise E.10.2.5.

11.2.8 H -Space Structure of $BGL(A)^+$. The classical direct sum of matrices

$$GL_n(A) \times GL_m(A) \rightarrow GL_{n+m}(A), \quad (\alpha, \beta) \mapsto \begin{bmatrix} \alpha & 0 \\ 0 & \beta \end{bmatrix}$$

can be extended (up to conjugation) to the whole group $GL(A)$ by using the checkerboard construction described in 10.2.12. The resulting group homomorphism is denoted

$$\oplus : GL(A) \times GL(A) \rightarrow GL(A).$$

When restricted to finite dimensional matrices this map is conjugate to the classical direct sum. The following theorem states that this construction induces on $BGL(A)^+$ the structure of a commutative H -space.

11.2.9 Proposition. *The map $\oplus_* : BGL(A)^+ \times BGL(A)^+ \rightarrow BGL(A)^+$ induced by the direct sum of matrices is associative and commutative up to homotopy. Therefore $BGL(A)^+$ is a homotopy commutative H -space.*

Proof. Applying the functor $B(-)^+$ to the map \oplus yields the map

$$B(GL(A) \times GL(A))^+ \rightarrow BGL(A)^+.$$

The canonical homotopy equivalence

$$B(GL(A) \times GL(A)) \cong BGL(A) \times BGL(A)$$

induces a homotopy equivalence

$$B(GL(A) \times GL(A))^+ \cong BGL(A)^+ \times BGL(A)^+,$$

whence, by composition, the map \oplus_* .

It suffices to prove the proposition for GL_n and then pass to the limit (telescope construction, cf. Appendix B.13). Since for finite dimensional matrices α, β and γ the direct sums $(\alpha \oplus \beta) \oplus \gamma$ and $\alpha \oplus (\beta \oplus \gamma)$ are conjugate by matrices which do not depend on α, β and γ (in fact permutation matrices), it suffices to show that for perfect groups H and G two conjugate maps from BH to BG induce homotopic maps from BH^+ to BG^+ . This is Lemma 11.2.10 below. Similarly $\alpha \oplus \beta$ and $\beta \oplus \alpha$ are conjugate by permutation matrices, and so commutativity holds up to homotopy by Lemma 11.2.10.

11.2.10 Lemma. *Let H and G be two groups and suppose that $[G, G]$ is perfect. Let $f, f' : H \rightarrow G$ be two group homomorphisms such that there exists $g \in [G, G]$ satisfying $f'(h) = gf(h)g^{-1}$ for any $h \in H$. Then the maps Bf^+ and $Bf'^+ : BH^+ \rightarrow BG^+$ are homotopic (that is basepointed homotopic).*

Proof. Since f and f' are conjugate the maps Bf and $Bf' : BH \rightarrow BG$ are freely homotopic, that is the basepoint of BH is not fixed during the

homotopy. In fact its image is the loop determined by g . Consequently the two maps Bf^+ and Bf'^+ are freely homotopic. But now the image of the basepoint, that is the loop determined by g in BG^+ , is homotopically trivial since $g \in [G, G]$ and $\pi_1(BG^+) = G/[G, G]$. Therefore one can modify the free homotopy from Bf^+ to Bf'^+ into a basepoint preserving homotopy. \square

11.2.11 Remark on the Loop-space Structure of $BGL(A)^+$. The space $BGL(A)^+$ is a loop-space (and even an infinite loop-space) and a delooping can be constructed as follows. Consider the disjoint union of spaces $\coprod_{n \geq 0} BGL_n(A)$ (where $BGL_0(A) = \{pt\}$). Then one can put a topological monoid structure on it by using the classical direct sum of matrices. Then the classifying space of this topological monoid $B(\coprod_{n \geq 0} BGL_n(A), \oplus)$ can be shown to be a delooping of $\mathbb{Z} \times BGL(A)^+$. In other words there is a canonical homotopy equivalence (given by the group completion theorem),

$$\Omega B \left(\coprod_{n \geq 0} BGL_n(A), \oplus \right) \cong \mathbb{Z} \times BGL(A)^+ .$$

This gives another functorial definition of the Quillen space (for details and proofs see G.Segal [1974]).

11.2.12 Corollary. *For any ring A , $H_*(GL(A), \mathbb{Q})$ is a Hopf algebra and the Hurewicz map induces an isomorphism of graded \mathbb{Q} -vector spaces*

$$\bigoplus_{n > 0} K_n(A) \otimes \mathbb{Q} \cong \text{Prim } H_*(GL(A), \mathbb{Q}).$$

Proof. The coalgebra structure of $H_*(GL(A), \mathbb{Q})$ is induced by the diagonal map. The point is to construct the algebra structure. It is induced by the direct sum of matrices as described in 11.2.8. Though the first part of this statement can be proved directly by using the fact that conjugation induces the identity map on the homology of discrete groups, it also follows from Proposition 11.2.9 since $H_*(BGL(A)^+) \cong H_*(BGL(A)) = H_*(GL(A))$.

Then, the classical theorem of Milnor-Moore asserts that, for an H -space, rational homotopy is the primitive part of rational homology (cf. Appendix A.11). Applied to $BGL(A)^+$ it gives the expected isomorphism. \square

11.2.13 Volodin Space Model for $BGL(A)^+$. The following construction, due to Volodin, exploits the fact that $GL(A)$ can be covered by triangular matrix subgroups. It will prove helpful in comparing algebraic K -theory with cyclic homology later on.

For any partial ordering γ of $\{1, \dots, n\}$ the triangular subgroup $T^\gamma(A)$ (also denoted $T_n^\gamma(A)$ if we need to specify n) of $GL(A)$ is defined by

$$T^\gamma(A) = T_n^\gamma(A) := \left\{ 1 + (a_{ij}) \in GL_n(A) \mid a_{ij} = 0 \text{ if } i \not\prec_\gamma j \right\} .$$

For instance, if γ is the standard ordering $\{1 < \dots < n\}$, then $T^\gamma(A)$ is the subgroup of upper triangular matrices. The inclusion $T^\gamma(A) \hookrightarrow GL(A)$ induces a cofibration on the classifying spaces $BT^\gamma(A) \hookrightarrow BGL(A)$.

By definition the *Volodin space* is the following union in $BGL(A)$,

$$X(A) := \bigcup_{\gamma} BT^\gamma(A) \hookrightarrow BGL(A).$$

11.2.14 Theorem. *For any ring A the connected space $X(A)$ is acyclic ($\tilde{H}_*(X(A)) = 0$) and is simple in dimension ≥ 2 .*

Proof (absence of). The original proof is due to Vaserstein [1976] and Wag-
 oner [1977]. We refer to Suslin [1981] for a short proof of this technical and
 important result. □

11.2.15 Corollary. *The Volodin space fits into a natural homotopy fibration*

$$X(A) \rightarrow BGL(A) \rightarrow BGL(A)^+$$

and therefore $\pi_1(X(A)) = St(A)$, $\pi_i(X(A)) = K_{i+1}(A)$ for $i \geq 2$.

Proof. Note that there is a canonical lifting of the group T^γ into $St(A)$ (cf. relations in 11.1.7). So $X(A)$ can also be viewed as a subspace of $BSt(A)$. This inclusion induces the isomorphism $\pi_1(X(A)) \cong St(A)$ on the fundamental groups, and its composition with $BSt(A) \rightarrow BGL(A)$ is the inclusion described in 11.2.13.

Consider the following commutative diagram

$$\begin{array}{ccccc} X(A) & \rightarrow & BSt(A) & \rightarrow & BGL(A) \\ \downarrow & & \downarrow & & \downarrow \\ X(A)^+ & \rightarrow & BSt(A)^+ & \rightarrow & BGL(A)^+ . \end{array}$$

We saw in the proof of 11.2.6 that the right-hand square is homotopy cartesian. For the left-hand diagram we can apply the homology spectral sequence comparison theorem to the vertical fibrations, since $X(A)$ is simple in dimension ≥ 2 (and then $X(A)^+$ also) and $BSt(A)^+$ is simply connected. So the fibers of the horizontal maps are homology equivalent, and since they are simply connected, they are also homotopy equivalent. This proves that the left-hand square is homotopy cartesian. In conclusion the three vertical maps have homotopy equivalent fibers.

The space $X(A)^+$ is acyclic and simply connected, so it is contractible. Hence the common fiber of the three vertical maps is homotopy equivalent to $X(A)$.

The last assertion follows from the long exact homotopy sequence of the fibration. □

11.2.16 Product in Algebraic K -Theory. For any rings A and A' there is defined a natural product

$$K_p(A) \times K_q(A') \rightarrow K_{p+q}(A \otimes_{\mathbb{Z}} A'), \quad p, q \geq 0,$$

which is graded commutative. When A is commutative it induces a graded commutative product on $K_*(A)$. We have already encountered this product for $p = q = 0$ in 8.2.2 and for $p = q = 1$ in 11.1.13. In this subsection we sketch its construction for $p, q \geq 1$ in the commutative case and refer to Loday [1976, Chap. 2] for more details.

By choosing a basis in the tensor product of modules $A^n \otimes A^m$ one can identify it with A^{nm} . Then the tensor product of matrices induces a group homomorphism

$$\otimes : GL_n(A) \times GL_m(A) \rightarrow GL_{nm}(A).$$

Note that any other choice induces a map which is conjugate to the first one. This map does not extend to GL because any non-identity matrix α tensored with the identity of $GL(A)$ gives a matrix $\alpha \otimes 1$ which is not in $GL(A)$. So we use the following trick. Let

$$\gamma_{n,m} : BGL_n(A)^+ \times BGL_m(A)^+ \rightarrow BGL_{nm}(A)^+ \rightarrow BGL(A)^+$$

be the map induced by \otimes and the stabilization map. Since $BGL(A)^+$ is in fact an H -group (cf. 11.2.11 or Exercise E.11.2.1) one can use the operation denoted $-$ (inverse up to homotopy) of the H -group structure to define a new map

$$\hat{\gamma}_{n,m}(x, y) = \gamma_{n,m}(x, y) - \gamma_{n,m}(*, y) - \gamma_{n,m}(x, *) ,$$

where $*$ is the basepoint of $BGL(A)^+$.

One can show, by using the fact that conjugation induces on $BGL(A)^+$ a map homotopic to the identity, that, up to homotopy, $\hat{\gamma}_{n,m}$ stabilizes and defines a map

$$\hat{\gamma} : BGL(A)^+ \wedge BGL(A)^+ \rightarrow BGL(A)^+ .$$

Here \wedge is the smash-product of basepointed spaces, that is $X \wedge Y = X \times Y / X \vee Y$. Taking the homotopy groups and identifying $S^p \wedge S^q$ with S^{p+q} gives the expected product.

Of course for $p = q = 1$ this product coincides with the product defined in 11.1.13. Note that modifying α (resp. β) into $D(\alpha)$ (resp. $D'(\beta)$) corresponds exactly to modifying γ into $\hat{\gamma}$.

If one starts with the space $\Omega B(\coprod_{n \geq 0} BGL_n(A), \oplus)$ to define algebraic K -theory, then the product is simply induced by the tensor product map which sends $BGL_n(A) \times BGL_m(A)$ into $BGL_{nm}(A)$.

11.2.17 Milnor K -Groups and Quillen K -Groups. The product defined above enables us to construct a natural map

$$p : K_n^M(A) \rightarrow K_n(A) ,$$

as follows. First embed A^\times into $K_1(A)$ (cf. 11.1.2). Then use the product in Quillen K -theory to define inductively a map $(A^\times)^n \rightarrow K_1(A)^n \rightarrow K_n(A)$. From the graded commutativity of the product this map factors through the exterior power (over \mathbb{Z}) $\wedge^n A^\times$. Moreover in $K_2(A)$ one has $\{u, 1 - u\} = \{u, -u\} = 0$ (cf. 11.1.15). So by definition of the Milnor K -groups this map factors naturally through $K_n^M(A)$.

11.2.18 Suslin's Stabilization Theorems. In this subsection F is an infinite field. Suslin has proved in [1984] the following stabilization theorem which is analogous to what we proved in Sect. 10.3 for Lie algebras,

$$(11.2.18.1) \quad H_i(GL_n(F)) \cong H_i(GL_{n+1}(F)) , \quad \text{for } i \geq n .$$

Moreover he was able to compute the first obstruction to stability:

$$(11.2.18.2) \quad H_n(GL_{n-1}(F)) \rightarrow H_n(GL_n(F)) \xrightarrow{\pi} K_n^M(F) \rightarrow 0$$

is an exact sequence.

This result yields a second way to compare Milnor and Quillen K -groups. In the diagram

$$K_n^M(F) \xrightarrow{p} K_n(F) \xrightarrow{h} H_n(GL(F)) \xleftarrow{i} H_n(GL_n(F)) \xrightarrow{\pi} K_n^M(F) ,$$

p is the product in algebraic K -theory, h is the Hurewicz homomorphism, i is induced by the stabilization map and π is the cokernel morphism in the exact sequence (11.2.18.2). Since by (11.2.18.1) i is an isomorphism, one can use its inverse. Then Suslin [1984] computed the composite $\pi i^{-1} h p$, and proved that it is the multiplication by $(n - 1)!$ on $K_n^M(F)$.

So far I do not know any counter-example to the following assertion:

(11.2.18.3) *the stabilization map $H_i(GL_n(F), \mathbb{Q}) \rightarrow H_i(GL_{n+1}(F), \mathbb{Q})$ is injective for all i and all $n \geq 1$.*

This is of course similar to what is conjectured for Lie algebras in 11.3.9. Since there is also defined a λ -decomposition on algebraic K -theory (see for instance Soulé [1985]) one conjectures that (with the notation of loc. cit. item 2.8),

(11.2.18.4) for any infinite field F (or even any local ring) the graded module $H_*(GL_r(F), \mathbb{Q})$ is isomorphic to the graded symmetric algebra over $\bigoplus_{i \geq 1} (\bigoplus_{j \leq r} K_i(F)_{\mathbb{Q}}^{(j)})$.

11.2.19 Relative Algebraic K -Theory. Let I be a two-sided ideal of A . The *relative algebraic K -groups* are defined for $n \geq 1$ by

$$K_n(A, I) := \pi_n(\mathcal{K}(A, I)),$$

where $\mathcal{K}(A, I)$ is the connected component of the basepoint in the homotopy fiber of the map $BGL(A)^+ \rightarrow BGL(A/I)^+$. Since this homotopy fiber is not connected in general ($K_1(A) \rightarrow K_1(A/I)$ need not be surjective), it will prove useful to introduce the group

$$\overline{GL}(A/I) := \{ \text{image of } GL(A) \text{ in } GL(A/I) \}.$$

Obviously this group contains $E(A/I)$ and the plus-construction space on $B \overline{GL}(A/I)$ with respect to $E(A/I)$ differs only from $BGL(A/I)^+$ by the fundamental group. Moreover it fits into a fibration of connected spaces

$$(11.2.19.1) \quad \mathcal{K}(A, I) \rightarrow BGL(A)^+ \rightarrow B \overline{GL}(A/I)^+.$$

By construction these relative K -theory groups fit into a long exact sequence

$$(11.2.19.2) \quad \dots \rightarrow K_{n+1}(A/I) \rightarrow K_n(A, I) \rightarrow K_n(A) \rightarrow K_n(A/I) \rightarrow \dots$$

A Volodin model for $\mathcal{K}(A, I)$ will be constructed in the next section.

11.2.20 Birelative Algebraic K -Theory. Similarly, if I and J are 2 two-sided ideals of A , then there is a commutative diagram of homotopy fibrations

$$\begin{array}{ccccc} \mathcal{K}(A; I, J) & \rightarrow & \mathcal{K}(A, J) & \rightarrow & \mathcal{K}(A/I, I + J/I) \\ \downarrow & & \downarrow & & \downarrow \\ \mathcal{K}(A, I) & \rightarrow & BGL(A)^+ & \rightarrow & B \overline{GL}(A/I)^+ \\ \downarrow & & \downarrow & & \downarrow \\ \mathcal{K}(A/J, I + J/J) & \rightarrow & B \overline{GL}(A/J)^+ & \rightarrow & B \overline{GL}(A/I + J)^+ \end{array}$$

which defines the space $\mathcal{K}(A; I, J)$. By definition the *birelative algebraic K -groups* of $(A; I, J)$ are

$$K_n(A; I, J) := \pi_n(\mathcal{K}(A; I, J)) \quad \text{for } n \geq 1.$$

By construction they fit into a long exact sequence

$$\begin{aligned} \dots \rightarrow K_{n+1}(A/J, I + J/J) \rightarrow K_n(A; I, J) \rightarrow K_n(A, I) \\ \rightarrow K_n(A/J, I + J/J) \rightarrow \dots \end{aligned}$$

(and similarly with I and J interchanged).

If by any chance the space $\mathcal{K}(A; I, J)$ happens to be contractible (that is $K_n(A; I, J) = 0$), then there is a long Mayer-Vietoris exact sequence

$$\begin{aligned} \dots \rightarrow K_{n+1}(A/I + J) \rightarrow K_n(A) \rightarrow K_n(A/I) \oplus K_n(A/J) \\ \rightarrow K_n(A/I + J) \rightarrow \dots \end{aligned}$$

So the birelative theory is the obstruction to the exactness of the Mayer-Vietoris sequence.

11.2.21 Algebraic K -Theory of Finite Fields. Let \mathbb{F}_q be the finite field with q elements. The computation of $K_n(\mathbb{F}_q)$ was done by D. Quillen [1972],

$$K_{2i}(\mathbb{F}_q) = 0, \quad \text{and} \quad K_{2i-1}(\mathbb{F}_q) \cong \mathbb{Z}/(q^i - 1)\mathbb{Z} \quad \text{for } i > 0.$$

In fact this computation was performed before the higher algebraic K -groups were properly defined. Quillen proved that the homotopy fiber of the map $\psi^q - Id : BU \rightarrow BU$, where ψ^q is the Adams operation on the infinite Grassmanian $BU = \lim_n BU(n)$, is the target of a map from $BGL(\mathbb{F}_q)$ which happens to be a homology equivalence. So this homotopy fiber \mathcal{F} has the homology of a $K(\pi, 1)$ and is an H -space. Quillen discovered the plus-construction in the attempt at building \mathcal{F} out of $BGL(\mathbb{F}_q)$. The final answer is, \mathcal{F} is homotopy equivalent to $BGL(\mathbb{F}_q)^+$. Then the computation of $K_*(\mathbb{F}_q)$ follows from the knowledge of the action of ψ^q on $\pi_*(BU)$.

11.2.22 Algebraic K -Theory of Rings of Integers in a Number Field.

Let \mathcal{O} be the ring of integers in a number field K (e.g. \mathbb{Z} in \mathbb{Q} , $\mathbb{Z}[i]$ in $\mathbb{Q}[i]$). In [1974] A. Borel performed the computation of $K_*(\mathcal{O}) \otimes \mathbb{Q}$ by computing the homology groups $H_*(GL(\mathcal{O}), \mathbb{Q})$ (then apply Corollary 11.2.12). This gives the following computation of the rank (of the free part) of $K_n(\mathcal{O})$. Let r_1 and r_2 be respectively the number of real and complex places of \mathcal{O} (for instance 1 and 0 for \mathbb{Z} , 0 and 1 for $\mathbb{Z}[i]$), then

$$\text{rank } K_n(\mathcal{O}) = \begin{cases} 1 & \text{for } n = 0, \\ r_1 + r_2 - 1 & \text{for } n = 1, \\ 0 & \text{for } n = 2i, \\ r_1 + r_2 & \text{for } n = 4i + 1, \quad i > 0, \\ r_2 & \text{for } n = 4i - 1, \quad i > 0. \end{cases}$$

Explicit generators for the free part were constructed by Soulé [1980] and Beilinson [1985].

Exercises

E.11.2.1. For any $\alpha \in GL(A)$ let α^t be the transposed matrix of α . Show that the group homomorphism $S : GL(A) \rightarrow GL(A)$, $S(\alpha) = (\alpha^t)^{-1}$ induces on $H_*(BGL(A)^+)$ the antipodal map.

E.11.2.2. Let X be a CW -complex. Show that there exists a discrete group G with a normal perfect subgroup N such that BG^+ (where the plus-construction is performed with respect to N) is homotopy equivalent to X (cf. Kan-Thurston [1976]).

E.11.2.3. Beilinson-Loday Symbol. Assume that for any noetherian ring A and any non-zero divisor element $x \in A$ there is a localization exact sequence

$$\dots \rightarrow K_n(A) \rightarrow K_n(A[x^{-1}]) \rightarrow K_{n-1}(A/(x)) \rightarrow K_{n-1}(A) \rightarrow \dots$$

Show that any n -tuple (a_1, \dots, a_n) of elements of A , such that $1 - a_1 a_2 \dots a_n$ is invertible, determines an element $\langle a_1, \dots, a_n \rangle \in K_n(A)$ which coincides with the Dennis-Stein symbol for $n = 2$ and which satisfies

$$\langle a_1, \dots, a_n \rangle = \{1 - a_1 a_2 \dots a_n\} \cup \{(-1)^n a_2\} \cup \dots \cup \{(-1)^n a_n\},$$

when a_2, \dots, a_n are invertible. (For the localization exact sequence see D. Quillen [1973]. For the symbols see Beilinson [1984], Guin [1982], Loday [1981b]. Such a symbol can be defined in any theory for which the localization sequence holds, for instance Deligne-Beilinson cohomology, cf. H. Esnault [1989].)

E.11.2.4. Higher Symbols. Let $a_1, \dots, a_n \in A$ be such that $a_1 a_2 = a_2 a_3 = \dots = a_n a_1 = 0$. Show that there exists a higher symbol $\langle\langle a_1, \dots, a_n \rangle\rangle \in K_n(A)$ with the following properties

- it is multilinear,
- it coincides with the Dennis-Stein symbol for $n = 2$,
- it is invariant under cyclic permutations (up to sign),
- it satisfies more generally (see above for the notation $\langle -, \dots, - \rangle$):

$$\sum_{\sigma \in S_n} \text{sgn}(\sigma) \langle\langle a_0, a_{\sigma(1)}, \dots, a_{\sigma(n)} \rangle\rangle = \langle\langle a_0, a_1, \dots, a_n \rangle\rangle$$

(cf. Loday [1981b], Ogle [1987], Geller-Reid-Weibel [1989, §7]).

E.11.2.5. Let I be a two-sided ideal of A and $x, y, z \in A$ such that $1 - xyz \in A^\times$, $xy, yz, zx \in I$. Denote by $\bar{x}, \bar{y}, \bar{z}$, their class in A/I . Show that the boundary map $\partial : K_3(A/I) \rightarrow K_2(A, I)$ sends $\langle\langle \bar{x}, \bar{y}, \bar{z} \rangle\rangle$ to

$$\langle xy, z \rangle - \langle x, yz \rangle + \langle zx, y \rangle$$

(cf. Loday [1981a]).

11.3 Algebraic K -Theory and Cyclic Homology of Nilpotent Ideals

The aim of this section is to compute the relative K -groups in terms of the relative cyclic homology groups for nilpotent ideals in characteristic zero. This theorem, due to T. Goodwillie in its final form, takes the form of an isomorphism

$$K_n(A, I) \otimes \mathbb{Q} \cong HC_{n-1}(A, I) \otimes \mathbb{Q} .$$

The two key points of Goodwillie’s proof are the following. First one works with the Volodin model of algebraic K -theory so that one can make the connection from GL to gl via Malcev’s theory of nilpotent groups. This yields an isomorphism of some homology groups which happen to be Hopf algebras. Taking the primitive part gives the relative K -theory on the GL side. Second, applying the Loday-Quillen-Tsygan theorem yields the isomorphism with relative cyclic homology on the gl side.

Though slightly different from what exists in the literature our proof is based on the articles of T. Goodwillie [1985a], B.L. Feigin and B.L. Tsygan [FT], C. Ogle and C. Weibel [1992], and also of A. Suslin and M. Wodzicki [1992].

Standing Assumptions. When there is no mention of a perfect group, it is understood that the plus-construction is performed with respect to the maximal perfect subgroup of the fundamental group.

11.3.1 Theorem (T. Goodwillie). *Let A be a ring and let I be a two-sided ideal which is supposed to be nilpotent. For any $n \geq 1$, there is a canonical isomorphism*

$$\varrho : K_n(A, I) \otimes \mathbb{Q} \cong HC_{n-1}(A, I) \otimes \mathbb{Q} .$$

In this statement the ground ring for cyclic homology is \mathbb{Z} , but in fact $HC_*^{\mathbb{Z}}(A, I)_{\mathbb{Q}} = HC_*^{\mathbb{Q}}(A_{\mathbb{Q}}, I_{\mathbb{Q}})$, cf. 2.1.16. Since, on the other hand, we will prove that $K_n(A, I)_{\mathbb{Q}} = K_n(A_{\mathbb{Q}}, I_{\mathbb{Q}})_{\mathbb{Q}}$ (Proposition 11.3.16), the main part of the proof will consist in proving the existence of an isomorphism

$$\varrho : K_n(A, I)_{\mathbb{Q}} \cong HC_{n-1}(A, I) ,$$

for any \mathbb{Q} -algebra A and any nilpotent ideal I .

11.3.2 Pattern of the Proof. The rational case is divided into 3 steps as follows.

From a certain family (indexed by the orderings γ) of nilpotent subgroups $T^{\gamma}(A, I)$ of $GL(A)$, one constructs a relative Volodin-type space $X(A, I) = \cup_{\gamma} BT^{\gamma}(A, I)$, which is a model for relative algebraic K -theory in the sense that there is an isomorphism

$$(a) \quad K_*(A, I) \cong \text{Prim } H_*(X(A, I)) .$$

This is the first step (from 11.3.3 to 11.3.9).

On the Lie side, one constructs a relative Volodin-type complex $x(A, I) = \sum_{\gamma} C_*(t^{\gamma}(A, I))$, where $t^{\gamma}(A, I)$ is the Lie sub-algebra of $gl(A)$ associated to the nilpotent group $T^{\gamma}(A, I)$. This is a model for relative cyclic homology in the sense that there is an isomorphism

$$(b) \quad HC_{*-1}(A, I) \cong \text{Prim } H_*(x(A, I)) .$$

This is the second step (from 11.3.10 to 11.3.12).

Then Malcev’s theory of nilpotent groups and nilpotent Lie algebras permits us to construct a map of Hopf algebras

$$(c) \quad H_*(X(A, I), \mathbb{Q}) \rightarrow H_*(x(A, I)),$$

which happens to be an isomorphism when restricted to each γ -piece,

$$H_*(BT^\gamma(A, I), \mathbb{Q}) \cong H_*(C_*(t^\gamma(A, I))) .$$

This ensures that the global map (c) is also an isomorphism. By restriction to the primitive part and using (a) and (b) (tensored with \mathbb{Q}) we get the expected isomorphism of Theorem 11.3.1. This is the third step (from 11.3.13 to 11.3.15).

The localization properties (see 11.3.16) yield the proof of the general case.

Note that the second part (Lie version) is in fact two-fold. The beginning is an analogue of the K -theory part with GL replaced by gl and algebraic K -theory replaced by “additive K -theory”. Then there is a computation of this additive K -theory in terms of cyclic homology using the Loday-Quillen-Tsygan theorem.

11.3.3 Relative Volodin Construction. For any ordering γ of $\{1, \dots, n\}$ the triangular subgroup $T^\gamma(A, I)$ (also denoted $T_n^\gamma(A, I)$ if we need to insist on n) of $GL(A)$ is defined by

$$T^\gamma(A, I) := \left\{ 1 + (a_{ij}) \in GL_n(A) \mid a_{ij} \in I \text{ if } i \not\prec_\gamma j \right\} .$$

The inclusion $T^\gamma(A, I) \subset GL(A)$ induces a cofibration on the classifying spaces,

$$BT^\gamma(A, I) \hookrightarrow BGL(A) ,$$

and by definition the *relative Volodin space* is the following union in $BGL(A)$

$$X(A, I) := \bigcup_{\gamma} BT^\gamma(A, I) .$$

Warning: the absolute Volodin space is acyclic, but not the relative one.

The fundamental group of $X(A, I)$ is the pullback $GL(A) \times_{GL(A/I)} St(A/I)$, whose maximal perfect subgroup is $E(A) \times_{E(A/I)} St(A/I)$. The plus-construction on $X(A, I)$ with respect to this maximal perfect subgroup yields the space $X(A, I)^+$.

11.3.4 Proposition. *The direct sum of matrices induces on $X(A, I)^+$ an H -space structure.*

Proof. For fixed n define $X_n(A, I) := \cup_{\gamma} BT_n^\gamma(A, I)$. The direct sum of matrices induces a group homomorphism

$$T_n^\gamma(A, I) \times T_{n'}^{\gamma'}(A, I) \rightarrow T_{n+n'}^{\gamma \vee \gamma'}(A, I),$$

where $\gamma \vee \gamma'$ is the obvious ordering of $\{1, \dots, n, \dots, n + n'\}$. By mimicking the argument of Proposition 11.2.9, one shows that the space $X(A, I)$ inherits an H -space structure from the direct sum of matrices. \square

Remark. A slightly different proof would be to use the topological monoid structure of $\coprod_{n \geq 0} X_n(A, I)$ in order to show that, as in 11.2.11, there is a canonical homotopy equivalence

$$\Omega B \left(\coprod_{n \geq 0} X_n(A, I) \right) \cong \mathbb{Z} \times X(A, I)^+.$$

11.3.5 Corollary. *For any ring A and any two-sided ideal I , there is a natural graded isomorphism*

$$\pi_*(X(A, I)^+) \otimes \mathbb{Q} \cong \text{Prim}(H_*(X(A, I), \mathbb{Q})).$$

Proof. This is a consequence of the Milnor-Moore theorem (cf. Appendix A.11) which asserts that in characteristic zero the primitive part of the homology of an H -space is its rational homotopy. So $\pi_*(X(A, I)^+) \otimes \mathbb{Q} \cong \text{Prim}(H_*(X(A, I)^+, \mathbb{Q}))$. Then the main property of the plus-construction permits us to replace $X(A, I)^+$ by $X(A, I)$ in the right-hand term. \square

The next result shows that $X(A, I)$ is the relevant space to look at.

11.3.6 Proposition. *For any ring A and any two-sided ideal I , there is a natural homotopy equivalence $X(A, I)^+ \cong \mathcal{K}(A, I)$ and therefore a natural isomorphism*

$$\pi_n(X(A, I)^+) \cong K_n(A, I) \quad \text{for } n \geq 1.$$

Note that we did not assume A to be a \mathbb{Q} -algebra in this statement.

Proof. By definition $K_n(A, I)$ is the n th homotopy group of the homotopy fiber $\mathcal{K}(A, I)$ (cf. 11.2.19). So, from the property of the plus-construction (cf. 11.2.2), it suffices to prove that there is a natural map

$$X(A, I) \rightarrow \mathcal{K}(A, I),$$

which is an isomorphism in homology (note that $\mathcal{K}(A, I)$ is simple because it is the fiber of an H -map). We first prove a lemma connecting relative Volodin spaces with absolute Volodin spaces.

11.3.7 Lemma. *The following square (in which $\overline{GL}(A/I)$ denotes the image of $GL(A)$ in $GL(A/I)$) is homotopy cartesian,*

$$\begin{array}{ccc} X(A, I) & \rightarrow & BGL(A) \\ \downarrow & & \downarrow \\ X(A/I) & \rightarrow & B\overline{GL}(A/I) . \end{array}$$

Proof. Let us work in the simplicial framework. The right-hand side vertical map is induced by a surjection of groups, hence it is a Kan fibration (cf. Appendix B.9). As a consequence it suffices to show that the square is a pull-back of simplicial sets.

An n -simplex (g_1, \dots, g_n) in $BGL(A)$ maps to some $B.T^\gamma(A/I) \subset B.\overline{GL}(A/I)$ iff $g_i \in T^\gamma(A, I)$ for all i . So such a simplex is also in $X(A, I)$ by definition of the Volodin space and conversely. Hence the simplicial pullback is $X(A, I)$. □

End of the Proof of Proposition 11.3.6. By Corollary 11.2.15 the following sequence is a homotopy fibration (see in 11.2.19 the definition of \overline{GL}),

$$X(A/I) \rightarrow B\overline{GL}(A/I) \rightarrow B\overline{GL}(A/I)^+ .$$

Therefore Lemma 11.3.7 implies that the following sequence is also a homotopy fibration because $X(A/I)^+$ is contractible,

$$X(A, I) \rightarrow BGL(A) \rightarrow B\overline{GL}(A/I)^+ .$$

In the following diagram

$$\begin{array}{ccccc} X(A) & \rightarrow & X(A, I) & \rightarrow & \mathcal{K}(A, I) \\ =\downarrow & & \downarrow & & \downarrow \\ X(A) & \rightarrow & BGL(A) & \rightarrow & BGL(A)^+ \\ =\downarrow & & \downarrow & & \downarrow \\ \{*\} & \rightarrow & B\overline{GL}(A/I)^+ & \xrightarrow{\cong} & B\overline{GL}(A/I)^+ \end{array}$$

the middle column is a fibration by our last argument, the right-hand column is a fibration by definition (cf. 11.2.19.1), and the middle row is a fibration by 11.2.15. It follows that the upper row is also a fibration (everything up to homotopy). Since $X(A)$ is acyclic (cf. 11.2.14), the map $X(A, I) \rightarrow \mathcal{K}(A, I)$ is a homology equivalence and so $X(A, I)^+$ is homotopy equivalent to $\mathcal{K}(A, I)^+$, which is $\mathcal{K}(A, I)$ since this space is simple. □

11.3.8 Corollary. $K_n(A, I)_{\mathbb{Q}} \cong \text{Prim}(H_n(X(A, I), \mathbb{Q}))$ for $n \geq 1$.

Proof. This is immediate from 11.3.5 and 11.3.6. □

11.3.9 Remark. Another way of phrasing the result of Proposition 11.3.6 is to say that

$$X(A, I)^+ \rightarrow BGL(A)^+ \rightarrow B\overline{GL}(A/I)^+$$

is a homotopy fibration (of H -spaces). Rationally the homology spectral sequence of this fibration is a spectral sequence of Hopf algebras of the form

$$E_{pq}^2 = H_p(B \overline{GL}(A/I)^+) \otimes H_q(X(A, I)^+) \Rightarrow H_{p+q}(BGL(A)^+).$$

Taking the primitive part yields an exact sequence of homotopy groups (cf. Appendix D.8), whose comparison with (11.2.19.2) yields the desired result.

We now enter the second part of the proof which deals with Lie algebras.

11.3.10 Lie Analogue of Volodin’s Construction. The Chevalley-Eilenberg complex associated to the Lie algebra \mathfrak{g} is denoted $C_*(\mathfrak{g})$ (cf. 10.1.3). For any ordering γ of $\{1, \dots, n\}$ let $t^\gamma(A)$ (resp. $t^\gamma(A, I)$) be the following nilpotent \mathbb{Q} -sub-algebra of the Lie algebra $gl(A)$

$$\begin{aligned} t^\gamma(A) &= \left\{ (a_{ij}) \in gl_n(A) \mid a_{ij} = 0 \text{ if } i \not\prec_\gamma j \right\} \\ \left(\text{resp. } t^\gamma(A, I) &= \left\{ (a_{ij}) \in gl_n(A) \mid a_{ij} \in I \text{ if } i \not\prec_\gamma j \right\} \right). \end{aligned}$$

There is a natural inclusion of complexes $C_*(t^\gamma(A, I)) \hookrightarrow C_*(gl(A))$ (resp. $C_*(t^\gamma(A, I)) \hookrightarrow C_*(gl(A, I))$) and by definition $x(A)$ (resp. $x(A, I)$) is the complex:

$$\begin{aligned} x(A) &:= \sum_{\gamma} C_*(t^\gamma(A)) \subset C_*(gl(A)) \\ \left(\text{resp. } x(A, I) &:= \sum_{\gamma} C_*(t^\gamma(A, I)) \subset C_*(gl(A, I)) \right). \end{aligned}$$

Mimicking the proof of the acyclicity of $X(A)$ shows that the complex $x(A)$ is acyclic in positive degrees (cf. Suslin and Wodzicki [1992, theorem 9.1]).

Continuing the analogy with the GL -group case (cf. Remark 11.3.9) one can show that there is a first quadrant spectral sequence of Hopf algebras

$$(11.3.10.1) \quad E_{pq}^2 = H_p(gl(A/I)) \otimes H_q(x(A, I)) \Rightarrow H_{p+q}(gl(A)).$$

11.3.11 Proposition. *The following is a long exact sequence*

$$\begin{aligned} \dots \rightarrow \text{Prim } H_{n+1}(gl(A)) &\rightarrow \text{Prim } H_{n+1}(gl(A/I)) \rightarrow \text{Prim } H_n(x(A, I)) \\ &\rightarrow \text{Prim } H_n(gl(A)) \rightarrow \text{Prim } H_n(gl(A/I)) \rightarrow \dots \end{aligned}$$

Proof. Taking the primitive part in the spectral sequence (11.3.10.1) yields a new spectral sequence with $E_{0n}^2 = \text{Prim } H_n(x(A, I))$, $E_{n0}^2 = \text{Prim } H_n(gl(A/I))$ and $E_{pq}^2 = 0$ for $p > 0$ and $q > 0$. Since the abutment is $\text{Prim } H_n(gl(A))$, one gets the expected exact sequence (cf. Appendix D.8). \square

Under the notation of additive K -theory (cf. remark after 10.2.5) this result can be rephrased as $K_n^+(A, I) \cong \text{Prim } H_n(x(A, I))$.

11.3.12 Proposition. $\text{Prim } H_n(x(A, I)) \cong HC_{n-1}(A, I)$ for $n \geq 1$.

Proof. The map $\text{tr} \circ \theta$ of 10.2.3 sends $x(A, I)$ into the kernel of $C^\lambda(A) \rightarrow C^\lambda(A/I)$, hence $\text{tr} \circ \theta$ sends the exact sequence of Proposition 11.3.11 into the exact sequence

$$(11.3.12.1) \quad \dots \rightarrow HC_n(A) \rightarrow HC_n(A/I) \rightarrow HC_{n-1}(A, I) \rightarrow HC_{n-1}(A) \rightarrow HC_{n-1}(A/I) \rightarrow \dots$$

Then this isomorphism is a consequence of the L - Q - T -theorem (cf. 10.2.4) for A and for A/I , and of the five lemma. \square

We now enter the third part of the proof.

11.3.13 Malcev's Theory. There is a 1-1 correspondence between nilpotent Lie algebras over \mathbb{Q} and uniquely divisible nilpotent groups. Starting with a nilpotent \mathbb{Q} -algebra \mathfrak{n} , the nilpotent group N is constructed as follows. Let J be the augmentation ideal of the universal enveloping algebra $U(\mathfrak{n})$. Denote by $U(\mathfrak{n})^\wedge = \lim_n U(\mathfrak{n})/J^n$ the completion of $U(\mathfrak{n})$ for the J -adic topology. The classical exponentiation map $\exp : J^\wedge \rightarrow 1 + J^\wedge$ is convergent in the J -adic topology. Then, by definition, the associated nilpotent group is

$$N := \exp(\mathfrak{n}) \subset (1 + J^\wedge)^\times .$$

Note that $\mathfrak{n} \mapsto N$ is a functor from the category of nilpotent Lie algebras to the category of nilpotent groups.

Under this functor the triangular matrix Lie algebra over the \mathbb{Q} -algebra A gives the triangular subgroup of the general linear group. More generally, the group associated to $t^\gamma(A, I)$ is $T^\gamma(A, I)$.

11.3.14 Proposition. For any nilpotent Lie algebra \mathfrak{n} over \mathbb{Q} there is a natural diagram of complexes

$$C_*(N) \rightarrow C_*(N, \mathfrak{n}) \leftarrow C_*(\mathfrak{n})$$

in which $C_*(N)$ denotes the Eilenberg-McLane complex of the discrete group N (cf. Appendix C.2) and $C_*(\mathfrak{n})$ denotes the Chevalley-Eilenberg complex of the Lie algebra \mathfrak{n} (cf. 10.1.3). Moreover these two maps are quasi-isomorphisms, and therefore there is a natural isomorphism

$$H_*(N, \mathbb{Q}) \cong H_*(\mathfrak{n}, \mathbb{Q}) .$$

Proof. Let $\mathbb{Q}[N]^\wedge$ (resp. $U(\mathfrak{n})^\wedge$) be the completion of $\mathbb{Q}[N]$ (resp. $U(\mathfrak{n})$) with respect to its augmentation ideal. By definition of N (in terms of \mathfrak{n}) there is

an inclusion $N \hookrightarrow U(\mathfrak{n})^\wedge$, that we can extend to a map $\mathbb{Q}[N] \rightarrow U(\mathfrak{n})^\wedge$ whose completion is

$$\mathbb{Q}[N]^\wedge \rightarrow U(\mathfrak{n})^\wedge .$$

The proof of the proposition is based on the following properties of these completed algebras for which we refer to the literature (cf. Pickel [1978]).

If \mathfrak{n} is a finitely generated nilpotent Lie \mathbb{Q} -algebra, then

- (1) the algebra map $\mathbb{Q}[N]^\wedge \rightarrow U(\mathfrak{n})^\wedge$ is an isomorphism of Hopf algebras (Malcev),
- (2) $\mathbb{Q}[N]^\wedge$ is flat as a $\mathbb{Q}[N]$ -module,
- (3) $U(\mathfrak{n})^\wedge$ is flat as a $U(\mathfrak{n})$ -module.

For any supplemented \mathbb{Q} -algebra R let $C_*^{\text{st}}(R)$ be the standard complex (functorial in R) which computes $\text{Tor}_*^R(\mathbb{Q}, \mathbb{Q})$.

In the following diagram

$$C_*(N) \rightarrow C_*^{\text{st}}(\mathbb{Q}[N]) \rightarrow C_*^{\text{st}}(\mathbb{Q}[N]^\wedge) \cong C_*^{\text{st}}(U(\mathfrak{n})^\wedge) \leftarrow C_*^{\text{st}}(U(\mathfrak{n})) \leftarrow C_*(\mathfrak{n})$$

- the middle map is an isomorphism by property 1 above,
- the two adjacent maps are quasi-isomorphisms by properties 2 and 3,
- the extreme maps are quasi-isomorphisms by the classical theorems which interpret homology of discrete groups and of Lie algebras respectively as Tor-functors (cf. Appendix C.3 and 10.1.5).

Since any nilpotent Lie \mathbb{Q} -algebra is the inductive limit of its finitely generated sub-Lie algebras, and since all the involved functors commute with inductive limits, the proposition is proved, with $C_*(N, \mathfrak{n})$ being the middle complex. □

See Exercise E.11.3.5 for another argument, based on an idea due to C. Ogle.

11.3.15 Corollary. *There is an isomorphism $H_*(X(A, I)) \cong H_*(x(A, I))$.*

Proof. Let γ' be an ordering which is finer than γ . Then there is a natural commutative diagram (where $T^\gamma = T^\gamma(A, I)$ and $t^\gamma = t^\gamma(A, I)$):

$$\begin{array}{ccccc} C_*(T^\gamma) & \rightarrow & C_*(T^\gamma, t^\gamma) & \leftarrow & C_*(t^\gamma) \\ \downarrow & & \downarrow & & \downarrow \\ C_*(T^{\gamma'}) & \rightarrow & C_*(T^{\gamma'}, t^{\gamma'}) & \leftarrow & C_*(t^{\gamma'}) . \end{array}$$

In other words there is a functor from the category of indices γ (which is a poset) to the category of diagrams of complexes and quasi-isomorphisms.

By gluing all these quasi-isomorphisms together one gets a diagram

(11.3.15.1)

$$C_*(X(A, I)) = \sum_{\gamma} C_*(T^\gamma) \rightarrow \sum_{\gamma} C_*(T^\gamma, t^\gamma) \leftarrow \sum_{\gamma} C_*(t^\gamma) = x(A, I) .$$

These two maps are still quasi-isomorphisms by a standard Mayer-Vietoris argument and Proposition 11.3.14. So we have shown that there is an isomorphism $H_*(X(A, I)) \cong H_*(x(A, I))$. \square

End of the Proof of Theorem 11.3.1 when A is a \mathbb{Q} -Algebra. Since on both sides of the isomorphism of Corollary 11.3.15 the coalgebra structure is induced by the diagonal map (cf. Pickel [1978]), the restriction to the primitive part is still an isomorphism. It suffices now to use Corollary 11.3.8 and Proposition 11.3.12 to get

$$K_*(A, I)_{\mathbb{Q}} \cong \text{Prim } H_*(X(A, I))_{\mathbb{Q}} \cong \text{Prim } H_*(x(A, I)) \cong HC_{*-1}(A, I). \quad \square$$

11.3.16 End of the Proof of Theorem 11.3.1. Now, the proof of Theorem 11.3.1 will be completed once we show that there are localization isomorphisms

$$HC_*(A, I)_{\mathbb{Q}} \cong HC_*(A_{\mathbb{Q}}, I_{\mathbb{Q}}) \quad \text{and} \quad K_*(A, I)_{\mathbb{Q}} \cong K_*(A_{\mathbb{Q}}, I_{\mathbb{Q}})_{\mathbb{Q}}.$$

For cyclic homology it is immediate by construction (cf. 2.1.16). For algebraic K -theory the proof is more elaborate.

11.3.17 Proposition. *Let A be a ring and I a two-sided nilpotent ideal of A . Then there are natural isomorphisms*

$$K_*(A, I)_{\mathbb{Q}} \cong K_*(A_{\mathbb{Q}}, I_{\mathbb{Q}}) \otimes \mathbb{Q}.$$

Proof. Since all these groups are primitive parts of corresponding Hopf algebras, it suffices to prove similar isomorphisms for the functor $H_*(X(-, -))$.

By a standard Mayer-Vietoris argument we are reduced to the functor $H_*(BT^\gamma(-, -))$.

Since $T^\gamma(A, I)$ is a nilpotent group, a spectral sequence argument reduces it to the proof of the isomorphisms

$$H_*(G, \mathbb{Z}) \otimes \mathbb{Q} \cong H_*(G_{\mathbb{Q}}, \mathbb{Z}) \otimes \mathbb{Q} \cong H_*(G_{\mathbb{Q}}, \mathbb{Q}),$$

when G is an abelian group. One can even suppose that G is finitely generated (then pass to the limit over the finitely generated subgroups). Then G is of the form $\mathbb{Z}^r \times \text{Tors}$ where Tors is the torsion subgroup of G , which is a finite group. In this case these isomorphisms are immediate. \square

Exercises

E.11.3.1. Let I and J be 2 two-sided ideals of A such that $I \cap J = 0$. Show that

$$K_1(A; I, J) = HC_0(A; I, J) = 0 \quad \text{and} \\ K_2(A; I, J) \cong HC_1(A; I, J) \cong I \otimes_{A^e} J.$$

(Cf. Bass [1968] or Milnor [1974] for the first statement and Guin-Waléry and Loday [1981] for the second.)

Conjecture. If $n!$ is invertible in A , then $K_{m+1}(A; I, J) \cong HC_m(A; I, J)$ for $m \leq n$ (see infra for the rational case).

E.11.3.2. Let I and J be 2 two-sided ideals of A such that $I \cap J$ is nilpotent. Show that there is an isomorphism of birelative theories

$$K_n(A; I, J) \otimes \mathbb{Q} \cong HC_{n-1}(A; I, J) \otimes \mathbb{Q}$$

(announced in Ogle and Weibel [1992]).

E.11.3.3. Let $f : R \rightarrow S$ be a homomorphism of simplicial rings such that the induced homomorphism $\pi_0(R) \rightarrow \pi_0(S)$ is a surjection with nilpotent kernel. Show that

$$K_n(f) \otimes \mathbb{Q} \cong HC_{n-1}(f) \otimes \mathbb{Q},$$

where $-(f)$ designates the relative theory (cf. Goodwillie [1985a], Fiedorowicz, Ogle and Vogt [1992]).

E.11.3.4. Generalize all the above results to the multirelative context (cf. Ellis [1988] for K_2 , Ogle-Weibel [1992] for the rational case).

E.11.3.5. Another Proof of the Isomorphism $H_*(N)_{\mathbb{Q}} \cong H_*(\mathfrak{n})_{\mathbb{Q}}$.

(a) Let N be a group whose commutator subgroup N' is abelian. Show that the Eilenberg-Mac Lane complex $C_*(N)$ is isomorphic to the twisted tensor product of complexes $C_*(N_{ab}) \otimes_{\tau} C_*(N')$, where the twisting cochain τ is a 2-cocycle defining the extension

$$1 \rightarrow N' \rightarrow N \rightarrow N_{ab} \rightarrow 1,$$

(see J.P. May [1967, §30] for the notion of twisting cochain).

(b) Show that for any abelian group G the map $(C(G), d) \rightarrow (\Lambda_{\mathbb{Z}}G, 0)$ induced by $(g_1, \dots, g_n) \mapsto g_1 \wedge \dots \wedge g_n$ is a map of complexes. Show, assuming 2 is invertible, that the above case gives rise to map of complexes

$$C_*(N) = C(N_{ab}) \otimes_{\tau} C(N') \rightarrow \Lambda(N_{ab}) \otimes_{\tau'} \Lambda(N') \cong (\Lambda(\mathfrak{n}), d),$$

where τ' is the twisting cochain induced by $x \wedge y \mapsto 1/2[\tilde{x}, \tilde{y}] \in N'$ for any $x, y \in N_{ab}$ (\tilde{x}, \tilde{y} are liftings to N of x and y). The last complex is the Chevalley-Eilenberg complex of $\mathfrak{n} \cong N_{ab} \oplus N'$.

(c) Iterate the above construction to construct, in characteristic 0, a quasi-isomorphism of complexes $C_*(N) \rightarrow C_*(\mathfrak{n})$ for any nilpotent torsion free group N . [Idea suggested by C. Ogle.]

E.11.3.6. Show that the λ -operations on algebraic K -theory (see for instance Soulé [1985]) extend to relative algebraic K -theory and that Goodwillie's map ϱ commutes with these λ -operations (cf. 5.6) (cf. Cathelineau [1991]).

11.4 Absolute and Relative Chern Characters

First we show that there exists a Chern character from K -theory to negative cyclic homology, which detects at least part of K -theory. The case of Banach algebras will be dealt with in the next section. The case of a nilpotent ideal, in relationship with the previous section, is treated in the second part of this section.

11.4.1 Absolute Chern Character. In Sect. 8.4 we defined a Chern character from $H_n(GL(A))$ to $HC_n^-(A)$ for any ring $A, k = \mathbb{Z}$. In fact it yields a map from $K_n(A)$ to $HC_n^-(A)$ as follows.

The Hurewicz map for the space $BGL(A)^+$ gives rise to

$$K_n(A) = \pi_n(BGL(A)^+) \rightarrow H_n(BGL(A)^+) \cong H_n(BGL(A)) = H_n(GL(A)).$$

Composed with the map ch^- it gives

$$ch_n^- : K_n(A) \rightarrow H_n(GL(A)) \rightarrow HC_n^-(A), \quad n \geq 1.$$

For $n = 0$ this Chern character map was described in Sect. 8.3. Summarizing, we have the following

11.4.2 Theorem. *For any ring A (considered as an algebra over the ground ring $k = \mathbb{Z}$) the graded map*

$$ch^- : K_*(A) \rightarrow HC_*^-(A),$$

is well-defined and functorial in A .

11.4.3 Absolute Chern Character with Values in HC . Under composition with the canonical map $HC_n^- \rightarrow HC_n^{\text{per}}$ (resp. $HC_n^- \rightarrow HC_{n+2r}$, $r \geq 0$), cf. 5.1.8 and 8.4.6, one gets the Chern character with values in periodic and cyclic homology respectively,

$$(11.4.3.1) \quad ch_n^{\text{per}} : K_n(A) \rightarrow HC_n^{\text{per}}(A),$$

$$(11.4.3.2) \quad ch_{n,r} : K_n(A, I) \rightarrow HC_{n+2r}(A).$$

By construction they commute with the periodicity map S :

$$(11.4.3.3) \quad \begin{array}{c} K_n(A) \\ \swarrow \text{ch}_n^- \quad \swarrow \text{ch}_n^{\text{per}} \quad \downarrow \text{ch}_{n,i} \quad \searrow \text{ch}_{n,i-2} \\ HC_n^-(A) \rightarrow HC_n^{\text{per}}(A) \rightarrow \dots \rightarrow HC_{n+2i}(A) \rightarrow HC_{n+2i-2}(A) \rightarrow \dots \rightarrow HC_n(A). \end{array}$$

Note also that composition with the map $h : HC_n^- \rightarrow HH_n$ induced by truncating the negative part of the bicomplex CC^- (cf. 8.4.5) gives the so-called Dennis trace map

$$(11.4.3.4) \quad \text{Dtr} = h \circ \text{ch}_n^- : K_n(A) \rightarrow HH_n(A).$$

11.4.4 Pairing with Cyclic Cohomology. Any element y in the cohomology group $HC_n^-(A)$ defines a function on $K_n(A)$ by

$$K_n(A) \xrightarrow{\text{ch}^-} HC_n^-(A) \xrightarrow{\langle y, - \rangle_{HC}} k,$$

where $\langle y, - \rangle_{HC}$ is the pairing in the negative cyclic theory. It would be desirable to have K -contravariant groups $K^n(A)$ and a Chern character $\text{ch}^* : K^n(A) \rightarrow HC_n^-(A)$ such that the following formula holds,

$$(11.4.4.1) \quad \langle \pi, \xi \rangle_K = \langle \text{ch}^*(\pi), \text{ch}_*(x) \rangle_{HC},$$

where $\langle -, - \rangle_K$ would be a pairing in K -theory.

A first attempt to define K^n is to take K_n of the category of finite dimensional representations of A in the sense of Quillen [1973] (cf. also Loday [1976, Chap. 5]).

In the Banach algebra case such K -contravariant functors have been defined by using Kasparov KK -theory ($K^n(A) := KK^n(A, \mathbb{C})$) and formula (11.4.4.1) has been proved (cf. Sect. 12.3).

11.4.5 Relative Chern Character. Our first aim is to construct a relative Chern character, that is a functorial map

$$\text{ch}_n^- : K_n(A, I) \rightarrow HC_n^-(A, I), \quad n \geq 1$$

for any ring A and any 2-sided ideal I . At first the ground ring for HC^- is \mathbb{Z} .

From the construction of the relative Volodin space done in 11.3.3, it is clear that $X(A, I)$ is the geometric realization of the sub-simplicial set $X_*(A, I) = \cup_{\gamma} B.T^\gamma(A, I)$. Hence $C_*(X(A, I))$ is a sub-complex of the Eilenberg-Mac Lane complex $C_*(GL(A))$, and its homology is $H_*(X(A, I))$.

In the following sequence

$$(11.4.5.1) \quad C_*(X(A, I)) \hookrightarrow C_*(GL(A)) \rightarrow \text{ToT } CC^-(A) \rightarrow \text{ToT } CC^-(A/I)$$

the middle arrow is the Chern character map at the complex level (cf. 8.4.4) and the last map is induced by the projection from A to A/I .

11.4.6 Lemma. *The above construction gives rise to a well-defined map of complexes*

$$C_*(X(A, I)) \rightarrow \text{Ker}(\text{ToT } CC^-(A) \rightarrow \text{ToT } CC^-(A/I)),$$

Proof. It suffices to show that the composite (11.4.5.1) is 0. In fact it suffices to show that this composite is 0 with $BT^\gamma(A, I)$ in place of $X(A, I)$. But then the image in $CC^-(A)$ is a certain bicomplex generated by elements (a_0, \dots, a_n) (in degree n) such that at least one entry is in I . So the image in $CC^-(A/I)$ is 0. \square

11.4.7 End of the Construction of the Relative Chern Character.

As a consequence of this lemma we get, on homology, a natural map

$$H_*(X(A, I)) \rightarrow HC_*^-(A, I)$$

since the relative HC^- group is, by definition, the homology of the above kernel. It suffices now to compose on the left with the Hurewicz map

$$K_n(A, I) = \pi_n(X(A, I)^+) \rightarrow H_n(X(A, I)),$$

as in the absolute case, to get the *relative Chern character*

$$\text{ch}_n^- : K_n(A, I) \rightarrow HC_n^-(A, I), \quad n \geq 1.$$

11.4.8 Proposition. *The absolute and relative Chern characters fit into a commutative diagram*

$$\begin{array}{ccccccccc} \dots & \rightarrow & K_{n+1}(A) & \rightarrow & K_{n+1}(A/I) & \rightarrow & K_n(A, I) & \rightarrow & K_n(A) & \rightarrow & K_n(A/I) & \rightarrow & \dots \\ & & \downarrow & & \downarrow & & \downarrow & & \downarrow & & \downarrow & & \\ \dots & \rightarrow & HC_{n+1}^-(A) & \rightarrow & HC_{n+1}^-(A/I) & \rightarrow & HC_n^-(A, I) & \rightarrow & HC_n^-(A) & \rightarrow & HC_n^-(A/I) & \rightarrow & \dots \end{array}$$

Proof. Of course we expect such a result. It is not completely straightforward since we used $BGL(A)^+$ to define absolute K -theory and $X(A, I)$ to define relative K -theory.

Let $C_*(GL(A), \overline{GL}(A/I))$ be the relative complex (defined as a kernel). It is immediate to show that the inclusion from $C_*(X(A, I))$ into $C_*(GL(A))$ lifts to $C_*(GL(A), \overline{GL}(A/I))$.

Between the two rows of the above diagram one can insert the following exact sequence

$$\begin{array}{ccccccc} \dots & \rightarrow & H_{n+1}(GL(A)) & \rightarrow & H_{n+1}(GL(A/I)) & \rightarrow & H_n(GL(A), \overline{GL}(A/I)) \\ & & & & & & \rightarrow H_n(GL(A)) \rightarrow \dots \end{array}$$

The commutativity from $H_*(GL)$ to HC_*^- is clear. On the other hand, for any fibration of connected spaces $F \rightarrow E \rightarrow B$, there is a commutative diagram of homotopy fibrations

$$\begin{array}{ccccc} F & \rightarrow & E & \rightarrow & B \\ \downarrow & & \downarrow & & \downarrow \\ \mathcal{F} & \rightarrow & SP^\infty E & \rightarrow & SP^\infty B, \end{array}$$

where $SP^\infty X$ stands for the *infinite symmetric product* of the connected space X . The homotopy of $SP^\infty X$ is the homology of X (this is the Dold-Thom theorem, cf. for instance May [1967] or G.W. Whitehead [1978]). It is known that $X \rightarrow SP^\infty X$ induces the Hurewicz map on homotopy and that $E \rightarrow \mathcal{F}$ factors naturally through $SP^\infty \mathcal{F}$.

Applying these general results to the fibration $X(A, I)^+ \rightarrow BGL(A)^+ \rightarrow B\overline{GL}(A/I)^+$ (cf. 11.3.9), we get $\pi_n(\mathcal{F}) = H_n(GL(A), \overline{GL}(A/I))$, and the map $\pi_n(\mathcal{F}) \rightarrow \pi_n(\mathcal{F})$ is precisely the composite

$$K_n(A, I) \rightarrow H_n(X(A, I)) \rightarrow H_n(GL(A), \overline{GL}(A/I)).$$

Hence we get the commutativity of the diagram from K_* to $H_*(GL)$ (maps between long homotopy exact sequences). □

11.4.9 The HC - HC^- - HC^{per} Sequence in the Relative Setting. From the definition of HC^- we derived immediately an exact sequence relating HC , HC^- and HC^{per} (cf. 5.1.5). It is clear, by taking kernels at the chain complex level, that such an exact sequence still exists in the relative setting,

$$\dots \rightarrow HC_{n-1}(A, I) \rightarrow HC_n^-(A, I) \rightarrow HC_n^{\text{per}}(A, I) \rightarrow HC_{n-2}(A, I) \rightarrow \dots$$

11.4.10 Proposition. *Let A be a \mathbb{Q} -algebra and I be a two-sided nilpotent ideal in A . Then $HC_*^{\text{per}}(A, I) = 0$ and therefore there is an isomorphism*

$$B : HC_{n-1}(A, I) \xrightarrow{\sim} HC_n^-(A, I).$$

Proof. The vanishing of the relative cyclic homology groups was proved in 4.1.15. The isomorphism follows from the exact sequence of 11.4.9. □

We can now compare the relative Chern character with Goodwillie's isomorphism ϱ .

11.4.11 Theorem. *Let A be a \mathbb{Q} -algebra and let I be a two-sided nilpotent ideal in A . Then the composite*

$$K_n(A, I) \xrightarrow{\varrho} HC_{n-1}(A, I) \xrightarrow{B} HC_n^-(A, I)$$

is the relative Chern character ch_n^- .

References for the proof. Goodwillie [1985a] see also Ogle-Weibel [1992].

Here is a suggestion for a different kind of proof using Ogle's trick (cf. Exercise E.11.3.5).

Recall that Goodwillie's map is defined on the subcomplex $\cup_\gamma C_*(BT^\gamma)$ of $C_*(BGL(A))$. So it suffices to check that the restriction of $B \circ \varrho$ and ch^- agree on $C_*(BT^\gamma)$.

By using Ogle’s trick one extends the twisting cochain method to CC^- and so one is reduced to the commutativity of the case when T^γ is abelian. In this latter case the associative algebra is $k \otimes I$ where the ideal I is such that $I^2 = 0$, then $T^\gamma = 1 + I$, and the associated commutative Lie algebra is $t^\gamma = I$ and the verification becomes straightforward. \square

11.4.12 Corollary. *For any \mathbb{Q} -algebra A and any two-sided nilpotent ideal I in A , the relative Chern character is an isomorphism:*

$$\text{ch}_n^- : K_n(A, I)_{\mathbb{Q}} \xrightarrow{\sim} HC_n^-(A, I) . \quad \square$$

Exercises

E.11.4.1. Show that the absolute Chern character commutes with the product on K -theory as defined in 11.2.16 and the product on cyclic homology as defined in 5.1.13. (cf Mc Carthy, R., The cyclic homology of an exact category, J. Pure Appl. Alg. 93 (1994), 251–296).

E.11.4.2. Show that the relative and absolute Chern characters ch_n^- commute with the λ -operations on algebraic K -theory (cf. the references in Exercise E.11.3.6) and on negative cyclic homology (cf. Exercise E.5.6.20). (Cf. Cathelineau [1991] for the relative case, use Gaucher [1992] for the absolute case.)

E.11.4.3. Compute the image of the symbols $\langle -, \dots, - \rangle$ and $\langle\langle -, \dots, - \rangle\rangle$ defined in Exercises E.11.2.3 and 4 by the Chern character maps.

11.5 Secondary Characteristic Classes

The classical Chern character can be viewed as a map from the K -theory of a space to its singular homology. The K -theory of a space is the same as the K -theory of its algebra of complex valued functions, and in fact the classical Chern character can be extended to a map from the topological K -theory of a Banach algebra A to periodic cyclic homology of A . The comparison with the algebraic K -theory of A and its associated Chern character with values in negative cyclic homology gives rise to a Chern character type map from the “relative K -theory” of the Banach algebra A to (ordinary) cyclic homology (see 11.5.6 and 11.5.7). This gives *secondary characteristic classes*.

The following is a survey without proofs of these secondary characteristic classes as defined and studied in Connes-Karoubi [1988] and Karoubi [1987], to which we refer for the proofs.

Standing Assumptions. In this section $k = \mathbb{C}$, A is a Banach algebra, and cyclic (as well as Hochschild, negative cyclic, periodic cyclic) homology takes

the topology of A into account. This means that, in the definition of these homology theories, the tensor product is replaced by the completed tensor product $\hat{\otimes}_\pi$ of Grothendieck (cf. 5.6.2). In the cohomological framework, the cochains have to be continuous.

11.5.1 Topological K -Theory of Banach Algebras. Let A be a Banach algebra and let $GL(A)$ be its general linear group. It is a topological group and $BGL(A)$ (or $B^{\text{top}}GL(A)$ if some confusion can arise) denotes its classifying space for which the topology is taken into account. Its homotopy groups are denoted $K_n^{\text{top}}(A) = \pi_n(BGL(A))$, $n \geq 1$. For $n = 0$, one simply puts $K_0^{\text{top}}(A) = K_0(A)$, the classical Grothendieck group. So, for $n = 0$, the topology does not play any role. However for $n = 1$ one has $K_1(A) \neq K_1^{\text{top}}(A)$ (for instance $K_1(\mathbb{C}) = \mathbb{C}^\times$ and $K_1^{\text{top}}(\mathbb{C}) = 0$). By Bott periodicity (cf. for instance Karoubi [1978]) topological K -theory is periodic of period 2,

$$K_{2n}^{\text{top}}(A) \cong K_0^{\text{top}}(A) \quad \text{and} \quad K_{2n+1}^{\text{top}}(A) \cong K_1^{\text{top}}(A), \quad n \geq 0.$$

For instance for $A = \mathbb{C}$ the topological group $GL(\mathbb{C})$ is homotopy equivalent to its subgroup $U = \lim_n U(n)$ (unitary group) and $BGL(\mathbb{C})$ is homotopy equivalent to the infinite Grassmanian BU . Hence $K_{2n}^{\text{top}}(\mathbb{C}) \cong \mathbb{Z}$ and $K_{2n+1}^{\text{top}}(\mathbb{C}) = 0$.

11.5.2 Relative K -Theory for Banach Algebras. Ignoring the topology, one can build a $K(\pi, 1)$ -space $B^\delta GL(A)$ which is the classifying space of the discrete group $GL(A)$. The identity map from the discrete group to the topological group is continuous and gives rise to a well-defined map of connected spaces

$$B^\delta GL(A) \rightarrow BGL(A).$$

Since $\pi_1(BGL(A))$ is abelian, this map factors through the Quillen space $B^\delta GL(A)^+$, (cf. Theorem 11.2.2) to give

$$B^\delta GL(A)^+ \rightarrow BGL(A).$$

By definition *relative K -theory of the Banach algebra A* is the homotopy theory of the homotopy fiber $B^{\text{rel}}GL(A)$ of this map,

$$K_n^{\text{rel}}(A) := \pi_n(B^{\text{rel}}GL(A)), \quad n \geq 1.$$

So, by definition, there is a homotopy fibration

$$(11.5.2.1) \quad B^{\text{rel}}GL(A) \rightarrow B^\delta GL(A)^+ \rightarrow BGL(A)$$

which gives rise to a long exact sequence

$$\dots \rightarrow K_n^{\text{rel}}(A) \rightarrow K_n(A) \rightarrow K_n^{\text{top}}(A) \rightarrow K_{n-1}^{\text{rel}}(A) \rightarrow \dots$$

One may even define an ad hoc K_0^{rel} -group so that this exact sequence goes as far as K_0^{top} .

Remark that the direct sum of matrices endows $B^{\text{rel}}GL(A)$ with a structure of commutative H -space.

11.5.3 Absolute Chern Character. Recall from Sects. 8.4 and 11.4 that the Hurewicz map composed with the Chern character defines, for any ring A , the Chern-Connes character map from algebraic K -theory to negative cyclic homology:

$$(11.5.3.0) \quad \text{ch}_n^- : K_n(A) \rightarrow HC_n^-(A) \quad n \geq 0 ,$$

(the case $n = 0$ was taken care of in Sect. 8.3) and by composition

$$(11.5.3.1) \quad \text{ch}_n^{\text{per}} : K_n(A) \rightarrow HC_n^{\text{per}}(A) ,$$

$$(11.5.3.2) \quad \text{ch}_{n,r} : K_n(A, I) \rightarrow HC_{n+2r}(A) .$$

11.5.4 Lemma. *Let A be a Banach algebra. The periodic Chern character ch_n^{per} factors through $K_n^{\text{top}}(A)$ to give the “classical” (or topological) Chern character*

$$\text{ch}_n^{\text{top}} : K_n^{\text{top}}(A) \rightarrow HC_n^{\text{per}}(A) .$$

References for the proof. Karoubi [1987] and Connes-Karoubi [1988]. Note that in the above statement the periodic cyclic homology group takes the topology of A into account (see standing assumptions). In the papers referred to above, it is shown that for any r the map $\text{ch}_{n,r}$ factors through $K_n^{\text{top}}(A)$. Taken at the chain level, this proof says, in essence, that the factorization factors through the periodic theory. \square

11.5.5 Topological Chern Character for Banach Algebras. The *topological Chern character* ch_n^{top} given by Lemma 11.5.4 is periodic of period 2. For M a smooth compact differentiable manifold, let $A = C^\infty(M)$ be the algebra of complex differentiable functions on M . Then one has $K_0^{\text{top}}(A) \cong K^0(M)$, $K_1^{\text{top}}(A) \cong K^{-1}(M)$ (topological K -theory of the space M) and also $HC_0^{\text{per}}(A) \cong H_*^{\text{ev}}(M)$, $HC_1^{\text{per}}(A) \cong H_*^{\text{odd}}(M)$ (de Rham or singular homology of the manifold M , cf. 5.6.4). Via these isomorphisms ch_n^{top} can be identified with the classical Chern character (cf. Karoubi [1987]).

11.5.6 Relative Chern Character for Banach Algebras. In Karoubi [1987] and Connes-Karoubi [1988, §3] it is shown that for any Banach algebra A there is defined a canonical *relative Chern character*

$$(11.5.6.1) \quad \text{ch}_n^{\text{rel}} : K_n^{\text{rel}}(A) \rightarrow HC_{n-1}(A) .$$

Let us give an idea of this construction in the particular case $A = \mathbb{C}$. Let G be a connected Lie group (here $G = GL_n(\mathbb{C})$) and let \mathfrak{g} be its Lie algebra. The group G is acting on the de Rham complex (Ω^*G, d) of the

manifold G and it is a classical result (cf. Chevalley-Eilenberg [CE]) that the invariant part of this complex under the action of G is isomorphic to the Chevalley-Eilenberg complex of cochains on \mathfrak{g}^* (dual of \mathfrak{g}):

$$(\Omega^p G)^G \cong \Lambda^p(\mathfrak{g}^*) \quad \text{and} \quad ((\Omega^* G)^G, d) \cong C^*(\mathfrak{g}) .$$

The inclusion of the invariant complex in its ambient de Rham complex yields a natural map

$$H^*(\mathfrak{g}) \rightarrow H^*(G) .$$

By duality one deduces a natural map of homology theories,

$$H_*(G) \rightarrow H_*(\mathfrak{g}) .$$

Here G is viewed as a topological space. By letting n tend to infinity for $G = GL_n(\mathbb{C})$, we get a map $H_*(GL(\mathbb{C})) \rightarrow H_*(gl(\mathbb{C}))$, whose restriction to the primitive part is

$$K_{*+1}^{\text{top}}(\mathbb{C}) = \pi_*(GL(\mathbb{C}))_{\mathbb{Q}} \rightarrow HC_{*-1}^{\mathbb{Q}}(\mathbb{C}) .$$

It turns out that this map factors through $K_*^{\text{rel}}(\mathbb{C})$ and gives ch_*^{rel} for $A = \mathbb{C}$.

11.5.7 Theorem. *Let A be a Banach algebra (or even a Fréchet algebra) and let the ground ring be $k = \mathbb{Q}$. Then, there is a commutative diagram with exact rows*

$$\begin{array}{cccccccc} \dots & \rightarrow & K_n^{\text{rel}}(A) & \rightarrow & K_n(A) & \rightarrow & K_n^{\text{top}}(A) & \rightarrow & K_{n-1}^{\text{rel}}(A) & \rightarrow & \dots \\ & & \downarrow \text{ch}_n^{\text{rel}} & & \downarrow \text{Dtr} & & \downarrow \text{ch}_{n,0} & & \downarrow \text{ch}_{n-1}^{\text{rel}} & & \\ \dots & \rightarrow & HC_{n-1}(A) & \rightarrow & HH_n(A) & \rightarrow & HC_n(A) & \rightarrow & HC_{n-2}(A) & \rightarrow & \dots \end{array}$$

Proof. Cf. Connes-Karoubi [1988]. □

11.5.8 Corollary. *Under the same hypotheses as above there is a commutative diagram with exact rows*

$$\begin{array}{cccccccc} \dots & \rightarrow & K_n^{\text{rel}}(A) & \rightarrow & K_n(A) & \rightarrow & K_n^{\text{top}}(A) & \rightarrow & K_{n-1}^{\text{rel}}(A) & \rightarrow & \dots \\ & & \downarrow \text{ch}_n^{\text{rel}} & & \downarrow \text{ch}_n^- & & \downarrow \text{ch}_n^{\text{per}} & & \downarrow \text{ch}_{n-1}^{\text{rel}} & & \\ \dots & \rightarrow & HC_{n-1}(A) & \rightarrow & HC_n^-(A) & \rightarrow & HC_n^{\text{per}}(A) & \rightarrow & HC_{n-2}(A) & \rightarrow & \dots \end{array}$$

whose composition with diagram 5.1.5 gives the commutative diagram of 11.5.7.

Hint for a proof: rewrite Connes-Karoubi’s proof of 11.5.7 by using the Dennis fusion-trace map (see 8.4.2) instead of the non-commutative differential forms. □

11.5.9 The Example $A = \mathbb{C}$. In this particular case one can compute the $HC-HC^- - HC^{per}$ sequence in terms of de Rham homology. In particular $H_{DR}^0(\mathbb{C}) = \mathbb{C}/\mathbb{Q}$ when the ground ring is \mathbb{Q} . Note that $\mathbb{C}/\mathbb{Q} \cong (\mathbb{C}^\times)/\text{Tors}$ where Tors is the torsion subgroup of \mathbb{C}^\times , that is the subgroup of roots of unity. Then the Chern character ch_n^- composed with the projection from $HC_{2n-1}^-(\mathbb{C})$ to $H_{DR}^0(\mathbb{C})$ gives a map

$$K_{2n-1}(\mathbb{C}) \rightarrow \mathbb{C}/\mathbb{Q} \cong (\mathbb{C}^\times)/\text{Tors} .$$

In fact there is a natural lifting $K_{2n-1}(\mathbb{C}) \rightarrow \mathbb{C}^\times$ which is an isomorphism on torsion (cf. Suslin, and Karoubi [1987], p.112).

11.5.10 Regulator Maps. For the ring of integers \mathbb{Z} the composite map $BGL(\mathbb{Z})^+ \rightarrow BGL(\mathbb{R})^+ \rightarrow BGL(\mathbb{R})$ is homotopically trivial. Therefore there is a lifting $BGL(\mathbb{Z})^+ \rightarrow B^{rel}GL(\mathbb{R})$ well-defined up to homotopy, and hence, after applying the homotopy group functor π_{4n+1} , a morphism

$$K_{4n+1}(\mathbb{Z}) \rightarrow K_{4n+1}^{rel}(\mathbb{R}) \xrightarrow{ch_n^{rel}} HC_{4n}^{\mathbb{R}}(\mathbb{R}) \cong \mathbb{R} .$$

The point is that the composite detects the free part of $K_{4n+1}(\mathbb{Z})$.

More generally let \mathcal{O} be the ring of integers in a number field. Embed \mathcal{O} in $\mathbb{R}^{r_1} \times \mathbb{C}^{r_2}$ where r_1 (resp. r_2) is the number of real (resp. complex) places of \mathcal{O} . Then the same procedure as above gives rise to maps $K_{4n-1}(\mathcal{O}) \rightarrow \mathbb{R}^{r_2}$ and $K_{4n+1}(\mathcal{O}) \rightarrow \mathbb{R}^{r_1+r_2}$ which are called *regulator maps* of \mathcal{O} .

The computation done by A. Borel (cf. 11.2.21) can be rephrased by saying that the regulator map tensored by \mathbb{R} over \mathbb{Z} is an isomorphism of real vector spaces for $n \geq 1$. Note that a set of generators for the free part of $K_{2n+1}(\mathcal{O})$ gives a basis of $\mathbb{R}^{r_1+r_2}$ or \mathbb{R}^{r_2} . The comparison of this basis with the basis coming from cyclic homology of \mathcal{O} over \mathbb{Z} gives, for all $n \geq 2$, a real number (volume of the lattice) which is called the *higher regulator*. These higher regulators together with the torsion of algebraic K -theory of \mathcal{O} are essential ingredients in the Lichtenbaum-Quillen conjectures which predict a formula for the value of the ζ -function of \mathcal{O} at negative integers (cf. Beilinson [1985], Soulé [1986]).

Exercise

E.11.5.1. Compare these secondary characteristic classes with the Cheeger-Chern-Simons character (cf. Cheeger-Simons [1985] and Karoubi [1990]).

Bibliographical Comments on Chapter 11

Papers on algebraic K -theory are numerous and the book Magurn [1984] contains all the reviews of the Mathematical Reviews related to the subject until 1984. Since

then, the reviews appear in Sect. 19 of the Mathematical Reviews. Basic and classical references are Bass [1968] and Milnor [1974] for low dimensional K -groups, Loday [1976] for Quillen's plus-construction and the multiplicative structure, Quillen [1973a] for the Q -construction and the basic properties of higher K -groups. For a generalization to the algebraic K -theory of spaces, see Waldhausen [1978, 1984].

The comparison theorem between K -theory of a nilpotent ideal is due to Goodwillie [1986]. A particular case using a slightly different method is in [FT]. The Volodin's construction appeared first in Volodin [1971], see also Vaserstein [1976] and Suslin [1981]. A generalization of Goodwillie's isomorphism to A^∞ -ring spaces is worked out in Fiedorowicz-Ogle-Vogt [1992]. For the comparison of homology of nilpotent groups and homology of Lie algebras, besides Pickel [1978] already mentioned, see Haefliger [1984]. A general theory of secondary characteristic classes has been undertaken by Karoubi [1990]. More recent results on multiplicative K -theory are to be found in: M. Karoubi, Sur la K -théorie multiplicative, preprint 1995.

Chapter 12. Non-commutative Differential Geometry

This chapter is an exposition, without any proof or detail, of some topics in Non-Commutative Differential Geometry (NCDG), which involve the cyclic theory.

Classically the geometric invariants of a manifold or of a topological space can be computed in terms of the algebra of C^∞ -functions or of the algebra of continuous functions. By construction these algebras are commutative. In fact a theorem of Gelfand asserts that there is a categorical duality between locally compact spaces and commutative C^* -algebras. In some geometric situations, for instance a foliation F on a manifold M , the space that one wants to look at (the space of leaves in this example) is so bad topologically that its algebra of functions is not relevant to construct interesting invariants. The idea of A. Connes is to construct, instead, a *non-commutative* C^* -algebra to describe the situation. In our example this C^* -algebra $C^*(M, \mathcal{F})$ is going to replace the algebra of functions over the space of leaves.

In the first section we give a brief account of this topic and we indicate how a classical invariant like the Godbillon-Vey invariant can be recovered from a cyclic cocycle on a dense sub-algebra of the algebra $C^*(M, \mathcal{F})$.

K -theory is well-adapted to get invariants of non-commutative algebras and formulas like in the Atiyah-Singer index theorem can be generalized in this setting. In the commutative case explicit computations of the index theorem can be made by using the Chern character with values in the de Rham theory. In the non-commutative case the cyclic theory was invented by A. Connes precisely to play the role of the de Rham theory. Then one can write an index formula by using cyclic cocycles. This is the content of Sect. 12.2 (see also 12.3.12.1).

In Sect. 12.3 we choose to illustrate the power of these results through the proof of the Novikov conjecture for hyperbolic groups as given by A. Connes and H. Moscovici. This conjecture claims the homotopy invariance of the higher signatures (numbers computed from the Pontrjagin classes of a manifold).

There is a version of the Novikov conjecture which can be translated word for word into the algebraic K -theory framework. It asserts that the rational “ K -theory assembly map”

$$H_{n-4k-1}(\Gamma, \mathbb{Q}) \rightarrow K_n(\mathbb{Z}\Gamma)_{\mathbb{Q}}$$

is injective. It turns out that a solution of this conjecture in a lot of cases, announced by M. Bökstedt, W.C. Hsiang and I. Madsen [1991], involves the cyclic theory (among other ingredients). Section 12.4 contains a brief outline of this work.

It is interesting to note that both proofs of the Novikov conjectures involve the Chern character in the cyclic theory but in different framework. Connes-Moscovici's proof, which handles the "hermitian" case, uses analysis (to be able to pass from the hermitian K -group to the linear K -group, i.e. K_0). On the other hand Bökstedt-Hsiang-Madsen's proof of the "linear" case uses an arithmetic method to check injectivity of the assembly map. Whether each proof can be translated into the other framework is a challenge for the younger mathematicians.

Finally we urge the reader to have a look at A. Connes' book "Géométrie Non-Commutative" [1990] in which he/she will find more applications (the index theorem for foliations, the quantum Hall effect) and a guide to the literature.

In this chapter the bibliographical comments are included in the text.

Standing Notation. For a paracompact space X the algebra of continuous functions which vanish at infinity is denoted by $C_0(X)$. The algebra of compact operators on a separable Hilbert space is denoted by \mathcal{K} . The space of C^∞ -sections of a bundle E over the C^∞ -manifold M is denoted by $C^\infty(M, E)$.

12.1 Foliations and the Godbillon-Vey Invariant

To any foliation \mathcal{F} on a C^∞ -manifold M one can associate a C^* -algebra which plays the role of the algebra of functions on the space of leaves. Then the Godbillon-Vey invariant (of a codimension 1 foliation) can be interpreted in terms of a cyclic cocycle over a dense subalgebra of $C^*(M, \mathcal{F})$. The main references are Connes [1986b], [1982 Chap. 7]. See also Chap. 2 of Connes [1990].

12.1.1 Foliations. Let M be a smooth manifold of dimension n and let TM be its tangent bundle. For each point $x \in M$ the fiber $T_x M$ is the tangent space of M at x . A C^∞ -foliation (foliation for short) is a smooth subbundle \mathcal{F} of TM which is *integrable*, i.e. which satisfies the following equivalent conditions:

- (a) $C^\infty(\mathcal{F}) = \{X \in C^\infty(M, TM), X_x \in \mathcal{F}_x \text{ for all } x \in M\}$ is a sub-Lie algebra of $C^\infty(M, TM)$,
- (b) the ideal $J(\mathcal{F})$ of smooth exterior differential forms which vanish on \mathcal{F} is stable under exterior differentiation,

- (c) for every $x \in M$ there exists a neighborhood $U \subset M$ and a submersion $\pi : U \rightarrow \mathbb{R}^q$ with $\mathcal{F}_y \in \text{Ker}(\pi_*)_y$ for all $y \in U$.

From the last condition we see that there is a second topology on M which looks locally like $\mathbb{R}^q \times \mathbb{R}^{n-q}$ with \mathbb{R}^q equipped with the discrete topology. The integer q is called the *codimension* of the foliation. The leaves of the foliation are the maximal connected submanifolds L (of dimension $n - q$) such that $T_x(L) = \mathcal{F}_x$ for all $x \in L$. The set of leaves is denoted by M/\mathcal{F} .

12.1.2 Examples. (a) *Submersion.* Any submersion $\pi : M \rightarrow B$ of manifolds defines a foliation whose leaves are the fibers. In this case the space of leaves has a nice topology since it is simply B .

(b) *Kronecker foliation of the torus.* The lines of slope $\theta \in \mathbb{R}$ determine a foliation of the torus $S^1 \times S^1$. If the torus is identified with $\mathbb{R}^2/\mathbb{Z}^2$ with coordinates (x, y) , then the differential equation is $dx = \theta dy$.

(c) *Lie group action.* Let G be a connected Lie group acting freely on the compact manifold M . The the orbits of G determine a foliation of M .

12.1.3 Godbillon-Vey Invariant. Let (M, \mathcal{F}) be a codimension 1 foliation with transverse orientation. Denote by ω a differential 1-form which defines \mathcal{F} ($\mathcal{F}_x = \text{Ker} \omega_x$). The Frobenius integrability property (condition (b) of 12.1.1) reads

$$\omega \wedge d\omega = 0 .$$

Hence there exists a differential 1-form θ such that $d\omega = \theta \wedge \omega$. One can show that the 3-form $\theta \wedge d\theta$, which is obviously closed, defines a cohomology class in $H^3(M, \mathbb{R})$ which is independent of the choice of ω (for a given \mathcal{F}) and of the choice of θ . This fact was discovered by C. Godbillon and J. Vey and this cohomology class is called the *Godbillon-Vey invariant* of the codimension 1 foliation. It is denoted by $GV(\mathcal{F})$.

The first example of a foliation with non-trivial GV-invariant is due to R. Roussarie. On the Lie group $SL_2(\mathbb{R})$ there exists a canonical basis $\{\omega, \alpha, \beta\}$ for the space of invariant 1-forms such that

$$d\omega = \omega \wedge \alpha , \quad d\alpha = \omega \wedge \beta , \quad d\beta = \alpha \wedge \beta .$$

(Compare with the classical generators of the Lie algebra $sl_2(\mathbb{R})$.) Let Γ be a discrete subgroup of $SL_2(\mathbb{R})$ such that the quotient $SL_2(\mathbb{R})/\Gamma$ is a compact manifold (such a group is called *cocompact*). Then the form ω is still well-defined on the quotient and determines a foliation. Its GV-invariant is non-trivial since $\alpha \wedge \omega \wedge \beta$ is a volume form. For a survey on the GV-invariant see Ghys [1989].

12.1.4 C^* -Algebra of a Foliation. In [1982] A. Connes associates canonically to any foliation (M, \mathcal{F}) a C^* -algebra denoted $C^*(M, \mathcal{F})$. If the foliation comes from a submersion (case (a) of 12.1.2) this C^* -algebra is $*$ -isomorphic

to $C_0(B) \hat{\otimes} \mathcal{K}$ (in other words $C^*(M, \mathcal{F})$ and $C_0(B)$ are Morita equivalent). In the case of the Kronecker foliation (case (b) of 12.1.2) with θ irrational, the C^* -algebra $C^*(M, \mathcal{F})$ is $*$ -isomorphic to $\mathcal{A}_\theta \hat{\otimes}_\pi \mathcal{K}$, where \mathcal{A}_θ is the C^* -algebra generated by two unitaries x and y which satisfy the relation $xy = e^{2\pi i \theta} yx$ (cf. 5.6.5).

In order to describe the Godbillon-Vey invariant of F by a cyclic cocycle we need to introduce a subalgebra \mathcal{A} of $C^*(M, \mathcal{F})$ as follows. For simplicity we suppose that \mathcal{F} has no holonomy (which is the case in example (c) of 12.1.2). The graph \mathcal{G} of the foliation consists of all pairs $(x, x') \in M \times M$ such that x and x' belong to the same leaf. It has a natural smooth manifold structure (in fact it is a differentiable groupoid). A smooth compactly supported function k (= kernel) on \mathcal{G} gives rise to a family of operators $K = \{K_L \mid L \in M/\mathcal{F}\}$ acting on the family of Hilbert spaces $\{L^2(L) \mid L \in M/\mathcal{F}\}$ by the formula

$$K_L f(x) = \int_{x' \in L} k(x, x') f(x') dx' .$$

These families form the convolution algebra of C^∞ -functions on \mathcal{G} with compact support denoted $\mathcal{A} := C_c^\infty(\mathcal{G})$. The C^* -algebra $C^*(M, \mathcal{F})$ of the foliation \mathcal{F} is the completion of $C_c^\infty(\mathcal{G})$ with respect to the norm $\|K\| = \sup_L \|K_L\|$.

Up to Morita equivalence, one can replace the differential groupoid \mathcal{G} by a reduced groupoid \mathcal{G}_T using a transversal T (meeting each leaf) to the foliation.

12.1.5 Transverse Fundamental Class of a Codimension 1 Foliation as a Cyclic Cocycle. For a codimension 1 foliation which is transversally oriented, the role of the fundamental class is played by the cyclic 1-cocycle τ defined as follows:

$$\tau(a, b) = \int_{\gamma \in \mathcal{G}_T} a(\gamma^{-1}) db(\gamma) ,$$

so $\tau \in HC^1(\mathcal{A})$. The form ω which defines the foliation gives rise to a weight ϕ on \mathcal{A} (non-commutative analogue of a positive measure). This weight determines a one-parameter group σ_t^ϕ in \mathcal{A} . Let H be the derivation on \mathcal{A} given by $\sigma_t^\phi = \exp(itH)$. Then the “derivative” $L_H \tau$ of τ with respect to τ is given by (cf. 4.1.4) :

$$L_H \tau(a_0, a_1) = \tau(H(a_0), a_1) + \tau(a_0, H(a_1)) .$$

By applying the contraction operator e_H (cf. 4.1.7), sometimes denoted i_H , one gets a cyclic 2-cocycle $e_H L_H \tau \in HC^2(\mathcal{A})$ which is an invariant of the foliation. It is a cocycle by the Bott vanishing theorem, $(L_H)^2 = 0$.

In order to describe the relationship with the GV-invariant one needs a localization map (cf. A. Connes [1990, Chap. 2 Sect. 4]),

$$l : HC^2(\mathcal{A}) \rightarrow H^3(M) ,$$

where the latter group is the cohomology of M twisted by the orientation of the transverse fiber space. To construct this map one takes advantage of the

local triviality of the foliation. Locally, \mathcal{A} is Morita equivalent to an algebra of C^∞ -functions on a smooth submanifold and one can use the comparison with de Rham cohomology (cf. 5.6.4) to get the map \underline{l} .

Finally the comparison with the GV-invariant reads as follows:

$$\underline{l}(\epsilon_H L_H \tau) = \text{GV}(\mathcal{F}) .$$

This allows Connes to prove results which can be stated independently of C^* -algebras, for instance the invariance under leafwise homotopy equivalence of the longitudinal L -genus paired with secondary classes of the foliation, and also the existence of an invariant measure on the canonical flow for foliations with non-trivial GV-invariant. This extends previous results of S. Hurder and A. Katok.

12.2 Fredholm Modules and Index Theorems

We first explain an elementary case of the index formula which serves as a model for the generalization. Then we expose briefly A. Connes' seminal work on the character of p -summable Fredholm modules. The last part is devoted to a generalization to θ -summable Fredholm modules. This version is, so far, the most efficient in the applications.

The main references for this section are A. Connes [C], [1991], Connes-Moscovici [1990].

12.2.1 The Index Formula in the Most Elementary Case. Let k be the ground field (which is going to be the field of complex numbers \mathbb{C} most of the time) and let A be a unital k -algebra. Let π be a finite dimensional (f.d.) representation of A in k , that is a k -algebra homomorphism $\pi : A \rightarrow \mathcal{M}_n(k)$. The isomorphism classes of f.d. representations of A form a monoid under the direct sum and the Grothendieck group (defined as in 8.2.2 with f.d. representations in place of f.g.p. modules) of this monoid is denoted $K^0(A) := K_0(\text{Rep}(A, k))$.

- (a) *Cohomological Chern Character.* Composing the trace map with the representation π gives rise to a linear map $\text{Tr} \circ \pi : A \rightarrow \mathcal{M}_n(k) \rightarrow k$ that we think of as a cyclic 0-cycle, denoted $\text{ch}^*(p) \in HC^0(A)$. It is easy to check that ch^* is a well-defined group homomorphism.
- (b) *Homological Chern Character.* On the other hand any idempotent e in $\mathcal{M}_r(k)$ determines an element $[e] \in K_0(A)$ and also an element $\text{ch}_*(e) \in HC_0(A)$ (cf. 8.3.6).
- (c) *K -Theory Pairing.* At the level of K -theory there is a well-defined pairing (cf. Loday [1976])

$$\langle -, - \rangle_K : K^0(A) \times K_0(A) \rightarrow \mathbb{Z}$$

obtained as follows. Firstly, one forms the idempotent $\pi_*(e)$ in $\mathcal{M}_{nr}(k)$ (apply π to the coefficients of e). Secondly, one takes the class of this idempotent into $K_0(\mathcal{M}_{nr}(k)) \cong K_0(k) = \mathbb{Z}$. Note that this is nothing but the dimension of the associated projective module. Finally one defines

$$\langle [\pi], [e] \rangle_K := \dim_k(\pi_*(e)) .$$

(d) *HC-Theory Pairing.* At the cyclic level there exists a well-defined pairing

$$\langle -, - \rangle_{HC} : HC^0(A) \times HC_0(A) \rightarrow k$$

which consists in evaluating a (cyclic) cocycle on a (cyclic) cycle (cf. 2.4.8).

12.2.2 Proposition. *The following diagram is commutative*

$$\begin{array}{ccc} K^0(A) \times K_0(A) & \xrightarrow{\langle -, - \rangle_K} & \mathbb{Z} \\ \text{ch}^* \times \text{ch}_* \downarrow & & \downarrow \text{inclusion} . \\ HC^0(A) \times HC_0(A) & \xrightarrow{\langle -, - \rangle_{HC}} & k \end{array}$$

In other words there is an equality called the index formula which reads as follows

$$(12.2.2.1) \quad \langle [\pi], [e] \rangle_K = \langle \text{ch}^*(\pi), \text{ch}_*(e) \rangle_{HC} .$$

Proof. It is a consequence of the following fact, the dimension of the projective module determined by an idempotent in $\mathcal{M}(k)$ is precisely given by the trace of this idempotent. □

12.2.3 Discussion of the Elementary Case. First one notes that the scalar $\langle \text{ch}^*(\pi), \text{ch}_*(e) \rangle_{HC} \in k$ is in fact an integer.

The previous result is far from being sufficient to handle problems like the Novikov conjecture or the idempotent conjecture because the set of objects we started with (f.d. representations) is not large enough, and so the image of ch^* is too small. Therefore the game consists in enlarging this set with more objects for which one can perform the constructions (a)-(b)-(c)-(d), and ultimately prove the index formula.

These generalizations will undergo two important modifications. The first one is technical, HC^0 has to be replaced by HC^{2n} and later on by HC_ϵ^{ev} (entire cyclic cohomology), and similarly for HC_0 . The second one is more difficult to handle, the algebra A has to be replaced by a subalgebra \mathcal{A} which depends on the given data. The cases which give highly valuable results arise when the inclusion $\mathcal{A} \rightarrow A$ induces an isomorphism on K_0 .

We describe briefly and without proofs the generalizations, together with some examples, in the rest of this section.

12.2.4 Fredholm Modules. From now on $k = \mathbb{C}$ and A is a \mathbb{C} -algebra with trivial $\mathbb{Z}/2\mathbb{Z}$ -grading. By definition a p -summable *Fredholm module* $\pi = (\mathcal{H}, F, \varepsilon)$ over A is

- a $\mathbb{Z}/2\mathbb{Z}$ -graded Hilbert space \mathcal{H} (with grading ε) equipped with a graded homomorphism π from A into the algebra $\mathcal{L}(\mathcal{H})$ of bounded operators in \mathcal{H} ,
- a bounded operator $F \in \mathcal{L}(\mathcal{H})$ such that

$$F^2 = 1, \quad F\varepsilon = -\varepsilon F \quad \text{and} \quad [F, a] := Fa - aF \in \mathcal{K} \quad \text{for any} \quad a \in A.$$

The trace map (i.e. a cyclic 0-cocycle) is not defined any more here because F need not be a traceable operator. Nevertheless, there is a way of associating a character map to π , provided that one works with a smaller algebra \mathcal{A}_p . In fact A. Connes constructs a cyclic $2n$ -cocycle τ depending on π ($2n \geq p - 1$) as follows.

12.2.5 The Character of a p -Summable Fredholm Module. The *Schatten ideal* $\mathcal{L}^p(\mathcal{H})$ is made of the operators T which verify the following growth condition

$$\mathcal{L}^p(\mathcal{H}) = \left\{ T \in \mathcal{L}(\mathcal{H}) \mid \sum \mu_n(T)^p < \infty \right\},$$

where $\mu_n(T)$ is the n th eigenvalue of $|T| = (T^*T)^{1/2}$. (For the properties of the Schatten ideals see for instance Appendix 1 in Connes [C]).

The subalgebra \mathcal{A}_p is defined by the requirements

$$\mathcal{A}_p := \{ a \in A \mid [F, a] \in \mathcal{L}^p(\mathcal{H}) \}.$$

When \mathcal{A}_p is norm-dense in A then the inclusion map from \mathcal{A}_p into A induces an isomorphism in K -theory. Since we are working with graded spaces we need to use the graded trace (also called super-trace)

$$\text{Tr}_s := (1/2)\text{Tr}(\varepsilon F[F, x]).$$

- (a) Under these notations the following $2n$ -cocycle (cocyclicity has to be checked!)

$$\tau(a_0, \dots, a_{2n}) := \text{Tr}_s(a_0[F, a_1] \dots [F, a_{2n}]),$$

is a *cyclic* cocycle on \mathcal{A}_p for all n such that $p \leq 2n + 1$. So it defines an element $\tau = \text{ch}^*(\pi)$ in $H_\lambda^{2n}(\mathcal{A}_p) = HC^{2n}(\mathcal{A}_p)$, which is called the *character of the Fredholm module* π (cf. Connes [C]). The cohomology class $\text{ch}^*(\pi) \in HC^{2n}(\mathcal{A}_p)$ is defined for n large enough. One can wonder about its behavior under varying n . It turns out that these characters correspond to one another by the S map from HC^{2n} to HC^{2n+2} (cf. loc.cit. Theorem 1 p.227). So the element $\text{ch}^*(\pi)$ should really be considered as an element in $HC_{\text{per}}^*(\mathcal{A}_p)$ and paired with $\text{ch}_*(e) \in HC_*^{\text{per}}(\mathcal{A}_p)$.

- (b) The homological Chern character $\text{ch}_* : K_0(\mathcal{A}_p) \rightarrow HC_{2n}(\mathcal{A}_p)$ has been constructed in Sect. 8.3.

- (c) For any idempotent matrix e with coefficients in \mathcal{A}_p the operator eFe from eH^+ to eH^- is a Fredholm operator. It means that its kernel and its cokernel are finite dimensional. Therefore it has an *index* which is $\dim \text{Ker}(eFe) - \dim \text{Coker}(eFe)$. This index, denoted by $\text{ind}(eFe)$, gives rise to the K -theory pairing by the formula

$$\langle [\pi], [e] \rangle_K := \text{ind}(eFe) \in \mathbb{Z}.$$

- (d) The HC -theory pairing has been constructed in 2.4.8 (evaluation of a cocycle on a cycle).

With these constructions A. Connes has proved the following *index formula* in this setting in [C, Cor. 3 p. 279] :

$$(12.2.5.1) \quad \langle [\pi], [e] \rangle_K = \langle \text{ch}^*(\pi), \text{ch}_*(e) \rangle_{HC} \quad \text{for } \pi = (\mathcal{H}, F, \varepsilon).$$

12.2.6 Example: The Tree. (Cf. Julg and Valette [1984]). Let Δ be a tree with vertices Δ^0 and edges Δ^1 . Let Γ be a discrete group acting freely on Δ (by a result of J.-P. Serre Γ is free):

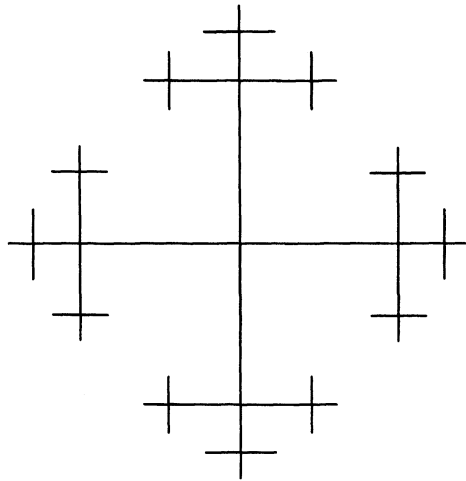

Part of the tree Δ corresponding to $\Gamma = \mathbb{Z} * \mathbb{Z}$.

A Fredholm module $\pi = (\mathcal{H}, F, \varepsilon)$ on $A = C_r^*(\Gamma)$ is defined as follows :

$$\begin{aligned} \mathcal{H}^+ &= \ell^2(\Delta^0), \quad \mathcal{H}^- = \ell^2(\Delta^1 \cup \{*\}) = \ell^2(\Delta^1) \oplus \mathbb{C}, \\ F &= \begin{bmatrix} 0 & U^* \\ U & 0 \end{bmatrix}, \end{aligned}$$

where U is the isomorphism $\mathcal{H}^+ \cong \mathcal{H}^-$ induced by the identification ϕ of Δ^0 with $\Delta^1 \cup \{*\}$ obtained as follows. First choose a vertex x_0 . Since Δ is a tree,

for any $x \in \Delta^0 - \{x_0\}$ there exists a unique path from x to x_0 . Then $\phi(x)$ is the edge of this path adjacent to x . For $x = x_0$ set $\phi(x_0) = *$.

One verifies that the algebra $\mathcal{A}_1 = \{a \in A \mid [F, a] \in \mathcal{L}^1(H)\}$ is dense in \mathcal{A} and that $\tau(a) = \text{Tr}_A(a)$ for all $a \in \mathcal{A}_1$. Here Tr_A denotes the canonical trace of A associated with the left regular representation of Γ in $l^2(\Gamma)$.

A consequence of the index formula is the integrality property

$$\langle K_0(A), \text{Tr}_A \rangle \subset \mathbb{Z},$$

which can be used to prove the following result due to Pimsner and Voiculescu [1982] (R.V. Kadison’s conjecture, cf. 8.5.6) :

If Γ is a free group, then the reduced C^ -algebra $C_r^*(\Gamma)$ does not contain any non-trivial idempotents.*

12.2.7 Theta-Summable Fredholm Modules. The integer p in the notion of p -summability corresponds to a dimension. But in many examples this dimension is ∞ . So A. Connes has introduced the notion of “ θ -summable Fredholm modules” to handle these cases. In this framework the character map takes values in the *entire cyclic cohomology* as defined in Sect. 5.6. Here are some more details taken out from Connes [1991].

Let A be a C^* -algebra and $\pi = (\mathcal{H}, F, \varepsilon)$ a Fredholm module over A . Let J be the 2-sided ideal of $\mathcal{L}(\mathcal{H})$ defined by

$$J = \left\{ T \in \mathcal{K} \mid \mu_n(T) = O\left((\text{Log } n)^{-1/2}\right) \right\}.$$

By definition the Fredholm module π is said to be θ -summable iff the subalgebra $\mathcal{A} = \{a \in A \mid [F, a] \in J\}$ is norm-dense in A . Note that any p -summable Fredholm module ($p < \infty$) is θ -summable.

In order to define the character of a θ -summable Fredholm module we work with the “complete” b - B -bicomplex, more precisely with the subcomplex which gives rise to entire cyclic cohomology (cf. 5.6.8).

For any θ -summable Fredholm module there exists (cf. loc. cit. Theorem 3) a self-adjoint operator D on \mathcal{H} such that

- (a) $D/|D|^{-1} = F$,
- (b) $\mathcal{A} = \{a \mid [D, a] \text{ is bounded}\}$ is norm-dense in A ,
- (c) $\text{Trace}(\exp(-D^2)) < \infty$.

Then it is proved in Connes [1988a] that these conditions are sufficient to construct an entire cyclic cocycle of \mathcal{A} . The simplest formula has been devised by A. Jaffe, A. Lesniewski and K. Ostwalder [1988] under the form

$$\begin{aligned} \phi(a_0, \dots, a_{2n}) = & \int_{0 \leq s_1 \dots \leq s_{2n} \leq 1} \text{Tr}_s \left(a_0 e^{-s_1 D^2} [D, a_1] e^{(s_1 - s_2) D^2} \dots \right. \\ & \left. \dots [D, a_{2n-1}] e^{(s_{2n} - s_{2n-1}) D^2} [D, a_{2n}] e^{(s_{2n} - 1) D^2} \right), \end{aligned}$$

with $a_i \in \mathcal{A}$.

Let us now stick to the case where $A = C_{\max}^*(\Gamma)$ (i.e. the enveloping C^* -algebra of the involutive Banach algebra $l^1(\Gamma)$), where Γ is a discrete group of finite type. By using the finiteness property of Γ , A. Connes constructs a Banach subalgebra $C_1(\Gamma)$ of A which is stable under holomorphic functional calculus (this ensures an isomorphism on K -theory) and whose entire cyclic cohomology receives the character of π ,

$$\text{ch}^*(\pi) \in HC_e^{\text{ev}}(C_1(\Gamma)).$$

Then, in Connes [1991, Theorem 7], it is shown that the index formula (12.2.5.1) holds in this framework.

12.3 Novikov Conjecture on Higher Signatures

We first describe Novikov conjecture and its origin which is the Hirzebruch signature formula. Then we describe briefly how the index theorem using the cyclic theory is used to prove the Novikov conjecture in the hyperbolic group case. The main references are Connes-Moscovici [1990], Connes-Gromov-Moscovici [1990, 1992]. There exist numerous surveys on the Novikov conjecture, for instance Fack [1988], Skandalis [1992], Weinberger [1990].

12.3.1 The Signature of a $4k$ -Manifold. Let $M = M^{4k}$ be a compact oriented C^∞ -manifold. The cup-product \cup in cohomology together with the evaluation on the fundamental class $[M]$ (via the Kronecker product $\langle -, - \rangle$) induces a symmetric bilinear form

$$H^{2k}(M, \mathbb{R}) \times H^{2k}(M, \mathbb{R}) \xrightarrow{\cup} H^{4k}(M, \mathbb{R}) \xrightarrow{\langle -, [M] \rangle} \mathbb{R}.$$

This symmetric bilinear form has a signature (number of $+1$ minus number of -1 in the diagonalized form) which is an integer denoted by $\text{sgn}(M)$ and called the *signature of the manifold M* .

12.3.2 Hirzebruch Signature Theorem. On the other hand the tangent bundle of M has got Pontrjagin classes p_i in the cohomology groups $H^{4i}(M, \mathbb{Z})$ (as any vector bundle over M). In the sixties F. Hirzebruch has proved the following striking theorem

For any positive integer k there exists a universal polynomial $L_k(x_1, \dots, x_k)$ with rational coefficients, such that, for any compact oriented C^∞ -manifold M of dimension $4k$, one has

$$\text{sgn}(M) = \langle L_k(p_1, \dots, p_k), [M] \rangle.$$

12.3.3 The L -Polynomials. In low dimensions the polynomials L_k are

$$L_1(p_1) = \frac{1}{3}p_1, \quad L_2(p_1, p_2) = \frac{1}{45}(7p_2 - p_1^2),$$

$$L_3(p_1, p_2, p_3) = \frac{1}{945}(62p_3 - 13p_2p_1 + 2p_1^3).$$

The general definition of L_k is as follows. Let $\{P_n(x_1, \dots, x_n)\}_{n \geq 1}$ be an infinite sequence of polynomials such that $P_n(x_1, \dots, x_n)$ is of degree n when x_i is of degree i for all i . This sequence is said to be *multiplicative* if for any elements $x = (x_1, x_2, \dots)$ and $y = (y_1, y_2, \dots)$ in a commutative graded algebra $A = A_0 \oplus A_1 \oplus A_2 \dots$ one has $P(x)P(y) = P(xy)$, where $P(x) = 1 + P_1(x_1) + \dots + P_n(x_1, \dots, x_n) + \dots$. For any formal power series $f(t) = 1 + \lambda_1 t + \lambda_2 t^2 + \dots$ there is one and only one such sequence which satisfies $P(1+t) = f(t)$, where t is in degree 1. The series

$$\frac{\sqrt{t}}{\text{th } \sqrt{t}} = 1 + \frac{1}{3}t - \frac{1}{45}t^2 + \dots + (-1)^{k-1} \frac{2^{2k}}{(2k)!} B_{2k} t^k + \dots,$$

where B_{2k} are the Bernoulli numbers, gives rise to the L -polynomials. By definition the L -class of M is the cohomology class

$$L(M) = \sum_k L_k(p_1(M), \dots, p_k(M)) \in H^*(M, \mathbb{Q}).$$

The series $t/1 - e^{-t}$ gives rise to the so-called \hat{A} -polynomials and the corresponding cohomology class is the *Todd class* denoted by $\text{Td}(M)$.

12.3.4 Homotopy Invariance of the L -Numbers. A priori the Pontrjagin classes depend on the differentiable structure of M . More precisely if $f : M \rightarrow M'$ is a homotopy equivalence which preserves the orientation, then in general $p_i(M) \neq p_i(M')$. However Hirzebruch's signature theorem implies that the numbers $\langle L(M), [M] \rangle$ and $\langle L(M'), [M'] \rangle$ are equal since f induces an isomorphism in homology. In other words:

The number $\langle L(M), [M] \rangle$ is homotopy invariant.

12.3.5 Higher Signatures. When $M = M^n$ is simply-connected there is no other homotopy invariant computed from the Pontrjagin classes. However in the non-simply connected case S.P. Novikov [1970] proposed to construct the following classes. Let $\Gamma = \pi_1(M)$ be the fundamental group of M and let $f : M \rightarrow B\Gamma$ be the classifying map of the universal cover \tilde{M} of M . Then any cohomological class $x \in H^*(B\Gamma, \mathbb{Q}) = H^*(\Gamma, \mathbb{Q})$ gives rise to an element $f^*(x) \in H^*(M, \mathbb{Q})$ and the element

$$\text{sgn}_x(M) := \langle L(M) \cup f^*(x), [M] \rangle = \langle x, f_*([M] \cap L(M)) \rangle$$

is called (somewhat mistakenly) a *higher signature* of M .

Let M' be another manifold and let $g : M' \rightarrow M$ be a homotopy equivalence of oriented manifolds. Then M and M' have the same fundamental

group Γ (in fact the two fundamental groups are canonically identified by g_*) and “ sgn_x is a homotopy invariant” means $\text{sgn}_x(M) = \text{sgn}_x(M')$ under the above hypothesis.

When the fundamental group Γ is commutative (essentially isomorphic to some \mathbb{Z}^r) Novikov was able to show that these numbers are homotopy invariant for any $x \in H^*(\mathbb{Z}^r)$. So he was led to make the following conjecture.

12.3.6 Novikov Conjecture on Higher Signatures. *For any cohomological class $x \in H^*(\Gamma, \mathbb{Q})$ the higher signature $\text{sgn}_x(M)$ is homotopy invariant.*

12.3.7 Remarks. For $x = 1 \in H_0(M)$ this conjecture is true by Hirzebruch’s theorem. For $x \in H_i(M)$, sgn_x is non-zero only if $n - i$ is divisible by 4, let us say $n - i = 4j$. And the combination of the Pontrjagin classes which is involved, is the L -polynomial L_j . A priori we are only interested in finitely generated groups since so is the fundamental group of a manifold. However a slightly different version of this conjecture makes it interesting for any kind of group (cf. 12.3.9).

12.3.8 Symmetric Signature. In the non-simply connected case there is an analogue of the bilinear symmetric form on $H^{2k}(M, \mathbb{R})$, which is as follows. Take a cellular decomposition of $M = M^n$ and consider the complex $C_*(\widetilde{M})$ of chains over a Γ -equivariant version of the universal cover \widetilde{M} . From the natural action of Γ on $C_*(\widetilde{M})$ and Poincaré duality one can construct an element in the Wall group $L_n(\mathbb{Q}[\Gamma])$. These groups are periodic of period 4 and for $n = 4k$ it is essentially the Grothendieck group of the f.d.p. modules equipped with a symmetric bilinear form, modulo the hyperbolic ones. This element is the *symmetric signature* and is denoted by $\Psi(M) \in L_n(\mathbb{Q}[\Gamma])$. Note that $\Psi(M)$ is a homotopy invariant by construction. If $\Gamma = 1$ and $n = 4k$, then $L_{4k}(\mathbb{Q}) \cong L_0(\mathbb{Q}) \cong \mathbb{Z}$ and the equivariant signature is identified with the classical signature.

12.3.9 The Assembly Map in L -Theory. The cap-product $[M] \cap L(M)$ is in $H_*(M, \mathbb{Q})$ and so $f_*([M] \cap L(M)) \in H_*(B\Gamma, \mathbb{Q})$. There is a map

$$H_{4^*+n}(\Gamma, \mathbb{Q}) \rightarrow L_n(\mathbb{Q}[\Gamma])_{\mathbb{Q}} ,$$

called the *assembly map*, which is functorial in Γ and which maps $f_*([M] \cap L(M))$ to $\Psi(M)$. Since $\Psi(M)$ is homotopy invariant, the injectivity of the assembly map (for finitely generated groups) would imply the Novikov conjecture. Note that, under this form, the Novikov conjecture makes sense for any group Γ .

In the sequel we suppose that the dimension of M is even. When the dimension of M is odd, there is a similar theory with K_1 in place of K_0 throughout.

12.3.10 Index Theorem of Kasparov and Mischenko. The natural map $\mathbb{Q}[\Gamma] \rightarrow C_r^*(\Gamma)$ induces a homomorphism $L_0(\mathbb{Q}[\Gamma]) \rightarrow L_0(C_r^*(\Gamma))$. Since the spectrum of a self-adjoint invertible element in a C^* -algebra A is included in \mathbb{R}^\times , one can show that there is a canonical isomorphism $L_0(A) \cong K_0(A)$. Putting these two maps together one gets

$$L_0(\mathbb{Q}[\Gamma]) \rightarrow L_0(C_r^*(\Gamma)) \cong K_0(C_r^*(\Gamma)).$$

To any pseudo-differential elliptic operator D on M , one can associate an *equivariant index* $\text{Ind}_\Gamma D$ in $K_0(C_r^*(\Gamma))$ where $\Gamma = \pi_1(M)$. The theorem of Kasparov and Mischenko asserts that, when D is the signature operator on M , the image of $\Psi(M)$ under the above map is precisely $\text{Ind}_\Gamma D$. This shows that $\text{Ind}_\Gamma D$ is homotopy invariant.

12.3.11 Baum-Connes Map. From the family of pseudo-differential elliptic operators on M one can construct a K -homology group $K_0(M)$ (former $Ell(M)$ group of Atiyah). By using the KK -theory of Kasparov one can even enlarge this construction to define the K -homology group with compact support $K_0(B\Gamma)$. The class determined by the operator D is denoted $\sigma_D \in K_0(M)$ (*symbol* of D) and its image in $K_0(B\Gamma)$ is $f_*(\sigma_D)$. Note that the Chern character $\text{ch}_*(\sigma_D)$ of σ_D is an element of $H_*(M, \mathbb{C})$.

P. Baum and A. Connes [1988a] have constructed a natural map

$$\mu : K_0(B\Gamma) \rightarrow K_0(C_r^*(\Gamma)),$$

which is the assembly map in the C^* -algebra setting. This map can be factored as follows.

Let \mathcal{R} be the algebra of infinite dimensional matrices over \mathbb{C} with rapid decay:

$$\mathcal{R} = \left\{ (\alpha_{m,n})_{m,n \geq 1}, \alpha_{m,n} \in \mathbb{C} \mid \exists k \text{ such that } \sum_{m,n} (m+n)^k |\alpha_{m,n}| < +\infty \right\}.$$

It is a subalgebra of the algebra \mathcal{K} of compact operators. Let E^+ and E^- be two C^∞ -complex vector bundles over M and let $D : C^\infty(M, E^+) \rightarrow C^\infty(M, E^-)$ be a pseudo-differential elliptic operator on M . There is a way of assigning to this data (cf. Connes-Moscovici [1990]) an idempotent P_D in $\mathcal{M}_2(\mathcal{R}\Gamma_+)$ ($\mathcal{R}\Gamma = \mathcal{R} \otimes \mathbb{C}[\Gamma]$, and $+$ means that a unit has been adjoined), whose class in $K_0(\mathcal{R}\Gamma)$ is denoted by $[P_D]$.

Connes and Moscovici showed that the map μ factors through $K_0(\mathcal{R}\Gamma)$ and that the image of $f_*(\sigma_D)$ is $[P_D]$ in $K_0(\mathcal{R}\Gamma)$ and $\text{Ind}_\Gamma D$ in $K_0(C_r^*(\Gamma))$:

$$\begin{array}{ccc} L_0(\mathbb{Q}[\Gamma]) & & \Psi(M) \\ \downarrow & & \downarrow \\ K_0(B\Gamma) \rightarrow K_0(\mathcal{R}\Gamma) \rightarrow K_0(C_r^*(\Gamma)), & & \begin{array}{l} D = \text{signature operator} \\ f_*(\sigma_D) \mapsto [P_D] \mapsto \text{Ind}_\Gamma D \end{array} \end{array}$$

Therefore when D is the signature operator the element $\mu(f_*(\sigma_D)) = \text{Ind}_\Gamma D$ is a homotopy invariant by Kasparov and Mischenko (see Hilsum and Skandalis [1992] for a more direct proof). As a consequence the rational injectivity of μ implies the Novikov conjecture. In fact Baum and Connes even conjecture that μ is an isomorphism without tensoring by \mathbb{Q} provided that Γ is torsion free.

12.3.12 Where the Cyclic Theory Comes in. Connes' idea is to use cyclic cohomology to prove the injectivity of μ . Let x be a cyclic cocycle determining $x \in H_\lambda^{2n}(\mathbb{C}\Gamma)$. There is defined a pairing with $K_0(\mathbb{C}\Gamma)$ by

$$\tau_x : K_0(\mathbb{C}\Gamma) \rightarrow \mathbb{C}, \quad \tau_x(e) := \langle x, \text{ch}_*(e) \rangle_{HC},$$

where e is an idempotent on $\mathcal{M}(\mathbb{C}\Gamma)$.

This pairing can easily be extended to $K_0(\mathcal{R}\Gamma)$ by using the trace map and we still denote by τ_x this extension.

We know from Sect. 7.4 that there is a canonical injective split map $H^n(\Gamma, \mathbb{C}) \hookrightarrow H_\lambda^n(\mathbb{C}\Gamma)$, so any cocycle x of Γ can be considered as a cyclic cocycle that we still denote by x .

One of the main results of Connes-Moscovici [1990] is the following index theorem,

– for any cohomology class $x \in H^{2n}(\Gamma, \mathbb{C})$ and any pseudo-differential elliptic operator D on the C^∞ -manifold M one has

$$(12.3.12.1) \quad \tau_x(\text{Ind}_\Gamma D) = \frac{1}{(2\pi i)^q} \frac{q!}{(2q)!} \langle x, f_*([M] \cap Td(M)) \cup \text{ch}_*(\sigma_D) \rangle.$$

Let us now specialize to the case of the signature operator. This index formula becomes

$$\tau_x(\text{Ind}_\Gamma D) = \langle x, f_*([M] \cap L(M)) \rangle = \text{sgn}_x(M).$$

Suppose that we would be able to extend the pairing τ_x from $K_0(\mathcal{R}\Gamma)$ to $K_0(C_r^*(\Gamma))$. Then the homotopy invariance of $\text{sgn}_x(M)$ would be proved since $\mu(P_D)$ is homotopy invariant. This is in general impossible. The strategy consists in constructing an ad hoc intermediate algebra \mathcal{A} :

$$\mathcal{R}\Gamma \rightarrow \mathcal{A} \rightarrow C_r^*(\Gamma)$$

which would be

- close enough to $\mathcal{R}\Gamma$ so that τ_x can be extended to $\tilde{\tau}_x : K_0(\mathcal{A}) \rightarrow \mathbb{C}$,
- close enough to $C_r^*(\Gamma)$ so that $\alpha : K_0(\mathcal{A}) \rightarrow K_0(C_r^*(\Gamma))$ is an isomorphism.

If such an \mathcal{A} exists, then $\text{sgn}_x(M) = \tau_x(P_D) = \tilde{\tau}_x \circ \alpha^{-1}(\text{Ind}_\Gamma D)$ and $\text{sgn}_x(M)$ is homotopy invariant.

Note that this extension problem is easily solved when x is the Chern character of a Fredholm module (cf. Sect. 12.2).

12.3.13 Novikov Conjecture for Hyperbolic Groups. By using the work of P. de la Harpe on the functions of rapid decay on Γ (extending

earlier work of U. Haagerup and P. Jolissaint), one can show that there exists a subalgebra \mathcal{A} of $C_r^*(\Gamma)$, which contains $\mathcal{R}\Gamma$ and is stable under functional calculus. It implies that the map $K_0(\mathcal{A}) \rightarrow K_0(C_r^*(\Gamma))$ is an isomorphism.

For any *bounded* cocycle x one can extend the pairing τ_x from $K_0(\mathcal{R}\Gamma)$ to $K_0(\mathcal{A})$. It suffices now to invoke a theorem of Gromov claiming that for a hyperbolic group Γ , any cohomology class $x \in H^n(\Gamma, \mathbb{C})$ ($n \geq 2$) can be represented by a bounded cocycle.

This is the pattern of the proof of Novikov conjecture for hyperbolic groups as given in Connes-Moscovici [1990].

12.3.14 Novikov Conjecture for Hyper-linear Elements. At the time of writing the ultimate proof of the Novikov conjecture is in Connes-Gromov-Moscovici [1992]. For any finitely generated discrete group Γ the authors introduce the notion of *hyper-linear* elements in $H^*(\Gamma, \mathbb{R})$. This notion is based on the Lipschitz maps $(\Gamma, d) \rightarrow \mathbb{R}^N$ where d is the word length metric on Γ . In this setting cyclic cohomology has to be replaced by *entire cyclic cohomology*. All cases for which the Novikov conjecture has been proved so far fall into this framework.

12.4 The K -Theoretic Analogue of the Novikov Conjecture

The Novikov conjecture gives information on the L -groups of the group algebra $\mathbb{Z}\Gamma$ in terms of the homology of Γ . One can wonder if a similar information can be obtained when one replaces the L -groups by the K -groups. Indeed, a K -theoretic analogue of the Novikov conjecture does exist, and takes the form of the injectivity of the K -theoretic assembly map, that I constructed in Loday [1976]. Several cases have been proved in the literature (T. Farrell and W.C. Hsiang, F. Waldhausen, P. Vogel).

When the Chern character with values in cyclic homology was known, there was some hope that it was the right kind of test map to check the injectivity of the K -theoretic assembly map. Ultimately M. Bökstedt, W.C. Hsiang and I. Madsen announced a proof which involves a generalization of this Chern character into Waldhausen's setting.

After constructing the K -theoretic assembly map we comment briefly on this proposed proof.

12.4.1 Assembly Map in K -Theory. As noted in 12.3.9 the Novikov conjecture would be implied by the injectivity of the assembly map in L -theory. This assembly map has an analogue in algebraic K -theory :

$$(12.4.1.1) \quad H_n(\Gamma, \mathbb{Q}) \oplus H_{n-4s-1}(\Gamma, \mathbb{Q}) \rightarrow K_n(\mathbb{Z}\Gamma)_{\mathbb{Q}}$$

and it is natural to hope it to be an injection.

In fact this map is induced from the *assembly map in K-theory*

$$(12.4.1.2) \quad \theta_n : h_n(B\Gamma, \underline{K}_{\mathbb{Z}}) \rightarrow K_n(\mathbb{Z}\Gamma) ,$$

where $\underline{K}_{\mathbb{Z}}$ is the spectrum associated to the algebraic K -theory of \mathbb{Z} (i.e. to the infinite loop space $\mathbb{Z} \times BGL(\mathbb{Z})^+$) and $h_*(-, \underline{K}_{\mathbb{Z}})$ denotes the corresponding extraordinary homology theory. Let us recall briefly the construction of θ as it was first given in Loday [1976, Sect. 4.1]. The idea is to embed Γ into $GL(\mathbb{Z}\Gamma)$ by

$$j : \Gamma \rightarrow (\mathbb{Z}\Gamma)^\times = GL_1(\mathbb{Z}\Gamma) \rightarrow GL(\mathbb{Z}\Gamma)$$

and then use the multiplicative structure of K -theory (cf. 11.2.16) as follows. The composite

$$B\Gamma_+ \wedge BGL(\mathbb{Z})^+ \xrightarrow{Bj^+ \wedge id} BGL(\mathbb{Z}\Gamma)^+ \wedge BGL(\mathbb{Z})^+ \xrightarrow{\hat{\gamma}} BGL(\mathbb{Z}\Gamma)^+$$

is compatible with the infinite loop space structure of $BGL(-)^+$ and therefore defines a map of spectra

$$B\Gamma_+ \wedge \underline{K}_{\mathbb{Z}} \rightarrow \underline{K}_{\mathbb{Z}\Gamma} .$$

By taking the homotopy groups one gets the assembly map (12.4.1.2) in algebraic K -theory,

$$\theta : h_* \left(B\Gamma, \underline{K}_{\mathbb{Z}} \right) = \pi_* \left(B\Gamma_+ \wedge \underline{K}_{\mathbb{Z}} \right) \rightarrow \pi_* \left(\underline{K}_{\mathbb{Z}\Gamma} \right) = K_*(\mathbb{Z}\Gamma) .$$

The same principle applies equally well in other frameworks like the Q -construction of Quillen or the Waldhausen’s K -theory of rings up to homotopy. In characteristic zero the spectrum $(\underline{K}_{\mathbb{Z}})_{\mathbb{Q}}$ splits as a product of Eilenberg-Mac Lane spectra (thanks to the computation of $K_*(\mathbb{Z})_{\mathbb{Q}}$ by A. Borel) and so we get the rational assembly map (12.4.1.1).

So far there is no counter-example to the injectivity of the assembly map θ (without tensoring by \mathbb{Q}) provided that Γ is torsion free (this is the *strong* K -theoretic analogue of the Novikov conjecture). The results of Quillen on the computation of $K_n(A[t, t^{-1}])$ and the compatibility of θ with the product imply the validity of the strong conjecture, when Γ is a free abelian group (cf. Loday, loc. cit.).

12.4.2 The Work of M. Bökstedt, W.C. Hsiang and I. Madsen [1992]. In 1991 these authors announced the following result:

The K-theoretic assembly map θ is injective for all groups Γ such that $H_i(\Gamma, \mathbb{Z})$ is finitely generated for all $i \geq 0$.

Here is a brief outline of the various steps of the proof as given in loc.cit.

(a) *Waldhausen’s A-Theory.* The first move is to change the framework from algebraic K -theory of “rings to homotopy”. More precisely the ring \mathbb{Z} is

replaced by the ring up to homotopy $\Omega^\infty S^\infty = \lim_n \Omega^n S^n$. Rationally it makes no difference since the stable homotopy groups of spheres are finite in positive dimensions (J.-P. Serre) and $\pi_0(\Omega^\infty S^\infty) = \lim_n \pi_n(S^n) = \mathbb{Z}$. For any topological space Y let us denote by $\tilde{Q}(Y)$ the space $\Omega^\infty S^\infty(Y)$. If $Y = \Omega X$ then $\tilde{Q}(\Omega X)$ is a ring up to homotopy which, for $X = B\Gamma$, is going to play the role of the group algebra $\mathbb{Z}\Gamma$. In [1978] Waldhausen has extended algebraic K -theory from rings to rings up to homotopy and this new theory is denoted $A(-)$. The relevant point, here, is the rational isomorphism

$$\pi_*(A(B\Gamma))_{\mathbb{Q}} \cong K_*(\mathbb{Z}\Gamma)_{\mathbb{Q}} .$$

(b) *Cyclotomic Trace Map.* The main ingredient of the proof is a generalization of the Chern character as described in Sect.8.4 to Waldhausen’s framework. First Hochschild homology is replaced by the so-called *topological Hochschild homology* devised by Bökstedt and the Dennis fusion-trace map from K -theory to Hochschild homology is extended to a trace map from Waldhausen theory to topological Hochschild homology. We know already that better results are obtained with cyclic theory in place of Hochschild theory. However, due to the fact that the map $\gamma : |\Gamma\Gamma| \rightarrow \mathcal{L}B\Gamma = \text{Map}(S^1, B\Gamma)$ of 7.3.11 is a G -homotopy equivalence for any finite subgroup G of S^1 but *not* for S^1 itself (cf. Exercise E.7.3.2), the authors have to use a p -variation of “topological cyclic homology”. Then, they are able to construct a lifting of the Dennis fusion-trace map to TC_p . They call this Chern character type map the “*cyclotomic trace map*”:

$$\text{Trc}_p : A(B\Gamma) \rightarrow TC_p(B\Gamma) .$$

(c) *Reducing the Problem to $\Gamma = 1$.* (Compare with Cohen-Jones [1990].) The topological cyclic theory TC_p comes equipped with a natural map

$$\alpha : TC_p(B\Gamma) \rightarrow \tilde{Q}(\Sigma_+(ES^1 \times_{S^1} \mathcal{L}_0 B\Gamma))_p^\wedge$$

in which we recognize the geometric realization of a cyclic set (cf. 7.3.11 and 7.2.2). Here $\Sigma_+ X$ denotes the suspension of X_+ , the subscript 0 means connected component and $(-)_p^\wedge$ means p -completion.

The cyclotomic trace map and α yield a commutative diagram

$$\begin{array}{ccc} B\Gamma_+ \wedge A(*) & \xrightarrow{\theta} & A(B\Gamma) \\ \downarrow & & \downarrow \text{Trc}_p \\ B\Gamma_+ \wedge TC_p(*) & \xrightarrow{\theta} & TC_p(B\Gamma) \\ \downarrow & & \downarrow \alpha \\ B\Gamma_+ \wedge \tilde{Q}(\Sigma_+ BS^1)_p^\wedge & \xrightarrow{\bar{\theta}} & \tilde{Q}(\Sigma_+(ES^1 \times_{S^1} \mathcal{L}_0 B\Gamma))_p^\wedge . \end{array}$$

Since $\bar{\theta}$ is a homotopy equivalence of spectra, injectivity of θ on the homotopy groups will follow from the injectivity (on homotopy) of $\alpha \circ \text{Trc}_p : A(*) \rightarrow \widehat{Q}(\Sigma_+ BS^1)_p^\wedge$, and from the technical condition on the homology groups of Γ (which ensures that $H_i(\Gamma)_{\mathbb{Q}} \rightarrow (\lim_n H_i(\Gamma) \otimes \mathbb{Z}/p^n \mathbb{Z})_{\mathbb{Q}}$ is injective).

(d) *The Last Step:* $\Gamma = 1$. In order to show that $\alpha \circ \text{Trc}_p$ induces an injection on $\pi_*(-)_{\mathbb{Q}}$ the authors utilize a construction of the Borel generators of $\pi_*(A(*)_{\mathbb{Q}}) = K_*(\mathbb{Z})_{\mathbb{Q}}$ due to C. Soulé [1980] to test their image by Trc_p . Then, comes up a factor $L_p(1 + 2m)$ which is the value at $1 + 2m$ of some p -adic L -function. Since this number is invertible when p is a regular prime (and possibly always) the proof of the theorem is completed.

Though the details are more complicated than this brief summary can let one think, there is some hope that a simpler proof emerges in the future (cf. Pirashvili-Waldhausen [1992]).

Exercise

E.12.4.1. Construct an assembly map for cyclic homology. Show that, in this framework, the Novikov conjecture is true.

Chapter 13. Mac Lane (co)homology

by Jean-Louis Loday and Teimuraz Pirashvili

The second Hochschild cohomology group of rings (that is algebras over $k = \mathbf{Z}$) classifies the extensions of a ring by a bimodule provided that the extensions are split as abelian groups. In order to classify non-split extensions, Mac Lane introduced in the fifties the so-called *Mac Lane (co)homology theory*, that we denote by HML and which is closely related to the cohomology of the Eilenberg-Mac Lane spaces. Hochschild (co)homology and Mac Lane (co)homology coincide when the ring contains the rational numbers, but they differ in general.

In the late seventies Waldhausen introduced a variant of algebraic K -theory, called *stable K -theory* and denoted K^s , in order to study the homology of the general linear group with coefficients in matrices. Kassel, and then Goodwillie, showed that stable K -theory is strongly related to Hochschild homology, for instance the Dennis trace map (cf. 8.4.3) factors through stable K -theory.

More recently (late eighties) Bökstedt, with some help by Waldhausen, introduced still another variant of Hochschild (co)homology, called *topological Hochschild (co)homology* and denoted THH , in order to study the algebraic K -theory of topological spaces as constructed by Waldhausen. This theory originated from the study of diffeomorphism groups of manifolds. It was also shown that the Dennis trace map factors through THH .

Mac Lane theory was completely forgotten until 1991, when it was proved by Jibladze and Pirashvili that Mac Lane cohomology has a nice interpretation in terms of *Ext*-groups in functor categories. Indeed, Hochschild cohomology is *Ext* over the category of bimodules (cf. 1.5.8) and, similarly, they proved that Mac Lane cohomology is *Ext* over the category of “non-additive bimodules”, that is functors from the category of finitely generated free modules to the category of modules (cf. 13.2.10). As an immediate consequence of the homological version of this result, they showed that the Dennis trace map factors through Mac Lane homology.

It turns out that these three theories, HML_* , K_*^s and THH_* , are isomorphic to each other and that the main tool to compare them is precisely the interpretation in terms of derived functors over the “non-additive bimodules”. The isomorphism between HML and THH was first proved by

Pirashvili and Waldhausen [1992] :

$$\begin{array}{ccc}
 HML_*(R) & & K_*^s(R) \\
 & \swarrow \cong & \searrow \cong \\
 & Tor_*^{\mathcal{F}(R)} & \\
 & \downarrow \cong & \\
 & THH_*(R) &
 \end{array}$$

Here R is a ring and $\mathcal{F}(R)$ is the category of nonadditive bimodules over R . The existence of an isomorphism between THH_* and K_*^s was first announced by Waldhausen [1987] (see also Schwänzl, Staffeldt and Waldhausen [1996]). The first complete proof for simplicial rings was published by Dundas and McCarthy [1994] .

The interpretation in the category of functors can also be expressed in terms of the homology of the small category $F(R)$ of f. g. free R -modules with coefficients in the Hom bifunctor. Not only does this tool permit us to construct the isomorphisms, but it helps greatly in doing computation. In the first three sections it is proved that, for any ring R , the following maps are isomorphisms

$$HML_*(R) \cong Tor_*^{\mathcal{F}(R)}(R, R) \cong H_*(F(R), Hom(R, R)) \cong K_*^s(R),$$

and similarly for the cohomological analogues. However we do not deal with topological Hochschild homology (nor with topological cyclic homology), which is beyond the scope of this book. The last section is devoted to the computation of $HML(\mathbf{Z})$ and $HML(\mathbf{Z}/p\mathbf{Z})$:

n	0	1	2	3	...	$2n$	$2n + 1$
$HML_n(\mathbf{Z}/p\mathbf{Z})$	$\mathbf{Z}/p\mathbf{Z}$	0	$\mathbf{Z}/p\mathbf{Z}$	0	...	$\mathbf{Z}/p\mathbf{Z}$	0
$HML_n(\mathbf{Z})$	\mathbf{Z}	0	0	$\mathbf{Z}/2\mathbf{Z}$...	0	$\mathbf{Z}/(n+1)\mathbf{Z}$

Here is the detailed content of the sections.

Section 13.1 begins with the definition of the category $\mathcal{F}(R)$, made of “non-additive bimodules” over R . This is the category of functors from the small category $F(R)$ to the category of R -modules. Then we define the (co)homology of R with coefficients in $T \in \mathcal{F}(R)$ as Tor or Ext functors. We also relate this (co)homology theory with the (co)homology of the category $F(R)$ with coefficients in the bifunctor Hom .

In section 13.2 we introduce Eilenberg-Mac Lane’s cubical construction and prove that its (co)homology is isomorphic to the stable (co)homology

of Eilenberg and Mac Lane spaces. Then we define the cup product on the cubical construction. As a result we get a chain algebra $Q_*(R)$ associated to the ring R and Mac Lane (co)homology of R is the usual Hochschild homology of the chain algebra $Q_*(R)$ with coefficients in R . Then we prove that Mac Lane (co)homology is isomorphic to the (co)homology theory introduced in the preceding section.

In section 13.3 we introduce stable K -theory in the sense of Waldhausen and then we prove the theorem asserting that stable K -theory and Mac Lane homology are isomorphic (via the homology of $F(R)$ with coefficients in Hom) according to the paper of Dundas and McCarthy [1994]. We are restricting ourselves to discrete rings. The method is to mix the homology of small categories with coefficients in bifunctors with Waldhausen S -construction.

In section 13.4 we give the computation of Mac Lane (co)homology for $\mathbf{Z}/p\mathbf{Z}$, where p is prime, and for \mathbf{Z} . This computation was first done by Bökstedt [1985] in terms of THH using heavy topological methods. It is interesting to mention that for the purpose of algebraic geometry Breen made calculation of some Ext groups (cf. Breen [1978]) by methods similar to those which were used latter on by Bökstedt for finite fields. Recently Franjou, Lannes and Schwartz [1994] gave purely algebraic calculation for finite fields and also explained the exact relationship between Breen's Ext-groups and Mac Lane cohomology. Our approach follows closely the calculation of Franjou, Lannes and Schwartz for prime fields and of Franjou and Pirashvili in the case of the ring of integers. The main tool to handle this computation is again the *Ext* and *Tor* interpretation in the category of functors.

We are grateful to Vincent Franjou, Randy McCarthy and John McCleary for their comments on a first draft of this chapter.

13.1 (Co)homology with Coefficients in Non-additive Bimodules

The aim of this section is to introduce a modification of Hochschild (co)homology of a ring R which will prove to be equivalent to Mac Lane (co)homology, stable K -theory and also to topological Hochschild (co)homology (not treated here). This modification is conceptually simple since it consists in replacing the category of R -bimodules by the category of “non-additive R -bimodules”, that is, the category $\mathcal{F}(R)$ of functors from the small category $F(R)$ of f. g. free R -modules to the category of R -modules. We give the axiomatic characterization of this theory and we prove its equivalence with (co)homology of the small category $F(R)$ with values in the bifunctor Hom . This construction plays a fundamental role in the comparison of the theories listed above.

Note that it would make no difference, in the sequel, to replace *free* by *projective* in the definition of $F(R)$.

13.1.1 Non-additive bimodules : the category $\mathcal{F}(R)$. The enveloping algebra of the ring R is denoted, as usual, $R^e := R \otimes R^{op}$. Denote by $R\text{-Mod}$ the category of left modules over R . Let $F(R)$ be the full subcategory of $R\text{-Mod}$ whose objects are the free modules $R^n, n \geq 0$. By abuse of terminology we say that $F(R)$ is the small category of finitely generated free R -modules. We denote by $I : F(R) \hookrightarrow R\text{-Mod}$ the embedding.

By definition a *non-additive R -bimodule* is a functor $T : F(R) \rightarrow R\text{-Mod}$ and the category of these functors, with natural transformations as morphisms, is denoted $\mathcal{F}(R)$. This category is abelian and possesses sufficiently many projective and injective objects. There is a full embedding $R^e\text{-Mod} = R\text{-Bimod} \hookrightarrow \mathcal{F}(R)$ given by $M \mapsto M \otimes_R -$, which establishes an equivalence of the category of R^e -modules with the full subcategory of $\mathcal{F}(R)$ consisting of additive functors. Consequently the objects of $\mathcal{F}(R)$ can be viewed as certain “non-additive bimodules”, and conversely, genuine bimodules can be identified with additive functors of $\mathcal{F}(R)$. Under this identification the R^e -module R corresponds to the inclusion functor $I : F(R) \hookrightarrow R\text{-Mod}$, which, therefore, is going to play an important role.

13.1.2 Linearization of functors. The embedding $R^e\text{-Mod} \hookrightarrow \mathcal{F}(R)$ has both left and right adjoint functors, which can be described as follows. Consider the following homomorphisms :

$$\delta^i : X \rightarrow X \oplus X \quad \text{and} \quad d_i : X \oplus X \rightarrow X,$$

where $i = 0, 1, 2$:

$$\begin{aligned} \delta^0(x) &= (0, x), \quad \delta^1(x) = (x, x), \quad \delta^2(x) = (x, 0), \\ d_0(x, y) &= y, \quad d_1(x, y) = x + y, \quad d_2(x, y) = x. \end{aligned}$$

Then for any functor $T \in \mathcal{F}(R)$, we set

$$\begin{aligned} \delta^X(T) &= T(\delta^0) - T(\delta^1) + T(\delta^2) : T(X) \rightarrow T(X \oplus X), \\ d_X(T) &= T(d_0) - T(d_1) + T(d_2) : T(X \oplus X) \rightarrow T(X). \end{aligned}$$

It is easy to check that $Ker \delta^X(T)$ and $Coker d_X(T)$ are additive functors on X . Hence for $X = R$ we have R^e -modules given by $Ker \delta^R(T)$ and $Coker d_R(T)$ which we denote respectively by Ad^0T and Ad_0T . These constructions give two functors Ad^0 and $Ad_0 : \mathcal{F}(R) \rightarrow R^e\text{-Mod}$. It turns out that Ad^0 (resp. Ad_0) is right (resp. left) adjoint to $R^e\text{-Mod} \hookrightarrow \mathcal{F}(R)$. Explicitly this means that one has isomorphisms:

$$\begin{aligned} Hom_{R^e}(M, Ad^0T) &\cong Hom_{\mathcal{F}(R)}(M \otimes_R -, T), \\ Hom_{R^e}(Ad_0T, M) &\cong Hom_{\mathcal{F}(R)}(T, M \otimes_R -). \end{aligned}$$

If we put $M = R$, then we get an isomorphism

$$Hom_{\mathcal{F}(R)}(I, T) \cong H^0(R, Ad^0T).$$

We leave to the reader the task to check that there is an isomorphism

$$I^* \otimes_{F(R),R} T \cong H_0(R, Ad_0T),$$

where $I^* : F(R)^{op} \rightarrow Mod\text{-}R$ is the functor given by $I^*(X) = Hom_R(X, R)$. Here we use the tensor product of functors as defined in Appendix C.

13.1.3 (Co)homology theory over $F(R)$. Since the abelian category $\mathcal{F}(R)$ has enough projective and injective objects, the cohomology of R with values in the functor $T : F(R) \rightarrow R\text{-}Mod$ is given by the derived functors of $Hom_{\mathcal{F}(R)}(I, T)$ and denoted

$$Ext_{\mathcal{F}(R)}^*(I, T).$$

Similarly the homology of R with values in the functor $T : F(R) \rightarrow R\text{-}Mod$ is given by the derived functors of $I^* \otimes_{F(R),R} T$, which are denoted $Tor_{*}^{F(R),R}(I^*, T)$ in Appendix C. Observe that, for the definition of cohomology, one only needs functors from $F(R)$ to $R\text{-}Mod$ (i.e. $\mathcal{F}(R)$). However, for the definition of homology, one needs functors from $F(R)$ and also from $F(R)^{op}$. Nevertheless, by abuse of notation, we denote these Tor -groups by

$$Tor_{*}^{\mathcal{F}(R)}(I^*, T).$$

When the functor T is determined by a bimodule M , that is, $T(-) = M \otimes_R -$, then we simply denote these groups by $Ext_{\mathcal{F}(R)}^*(R, M)$ and $Tor_{*}^{\mathcal{F}(R)}(R, M)$, respectively.

Observe that the natural embedding $R^e\text{-}Mod \hookrightarrow \mathcal{F}(R)$ induces natural maps to (resp. from) Hochschild (co)homology :

$$\alpha^* : H^*(R, M) = Ext_{R^e}^*(R, M) \rightarrow Ext_{\mathcal{F}(R)}^*(R, M),$$

$$\alpha_* : Tor_{*}^{\mathcal{F}(R)}(R, M) \rightarrow Tor_{*}^{R^e}(R, M) = H_*(R, M).$$

13.1.4 Axioms for homology. In the sequel we use the following well-known axiomatic characterization of derived functors for the groups $Tor_{*}^{\mathcal{F}(R)}(I^*, -)$. It is also used in Pirashvili-Waldhausen [1992] to identify them to THH .

13.1.5 Proposition. *The family of functors $\mathcal{H}_n(R, -) := Tor_n^{\mathcal{F}(R)}(I^*, -)$ is the unique (up to isomorphism) family of functors $\mathcal{H}_n(R, -) : \mathcal{F}(R) \rightarrow Ab$ satisfying the following properties*

i) *for any short exact sequence of functors*

$$0 \longrightarrow T_1 \longrightarrow T \longrightarrow T_2 \longrightarrow 0$$

there exists a natural long exact sequence of abelian groups

$$\cdots \longrightarrow \mathcal{H}_{n+1}(R, T_2) \longrightarrow \mathcal{H}_n(R, T_1) \longrightarrow \mathcal{H}_n(R, T) \longrightarrow \mathcal{H}_n(R, T_2) \longrightarrow \cdots,$$

- ii) if $n > 0$ and P is a projective object in $\mathcal{F}(R)$, then $\mathcal{H}_n(R, P) = 0$,
- iii) one has a natural isomorphism $\mathcal{H}_0(R, T) \cong H_0(R, Ad_0T)$. □

There is a similar characterization for cohomology.

13.1.6 Relationship with (co)-homology of small categories.

(Co)homology of a small category with coefficients in a bifunctor is defined in Appendix C. Here the small category is $F(R)$ and the bifunctor is $Hom(I, T)$ given by $(X, Y) \mapsto Hom(X, T(Y))$. It is immediate to check that

$$Ext_{\mathcal{F}(R)}^0(I, T) \cong H^0(F(R), Hom(I, T))$$

and

$$Tor_0^{\mathcal{F}(R)}(I^*, T) \cong H_0(F(R), Hom(I, T)).$$

More generally one has the following identification.

13.1.7 Theorem. *For any ring R and any functor $T \in \mathcal{F}(R)$ there are canonical isomorphisms*

$$Ext_{\mathcal{F}(R)}^*(I, T) \cong H^*(F(R), Hom(I, T)),$$

$$Tor_*^{\mathcal{F}(R)}(I^*, T) \cong H_*(F(R), Hom(I, T)).$$

Proof. For the Tor case this is a consequence of the spectral sequence C.10.1 (see Appendix C), where we put $C = F(R)$, $M = I^*$, $N = T$. We leave it to the reader to dualize this argument for cohomology. □

13.1.8. Trace map with values in $H_*(F(R), Hom)$. As mentioned in the introduction of this chapter the Dennis trace map (see 8.4.3)

$$Dtr : H_*(GL(R), \mathbf{Z}) \rightarrow HH_*(R)$$

factors through Mac Lane homology. In fact we will show here that it factors through $H_*(F(R), Hom)$.

By the isomorphism 13.1.7 one can consider the map α_* in 13.1.3 as a map

$$\alpha_* : H_*(F(R), Hom) \rightarrow HH_*(R),$$

so we need to construct a lifting

$$DTr : H_*(GL(R), \mathbf{Z}) \rightarrow H_*(F(R), Hom).$$

The homomorphism DTr is obtained by composition of two homomorphisms

$$H_*(GL(R), \mathbf{Z}) \rightarrow H_*(GL(R), M(R))$$

and

$$H_*(GL(R), M(R)) \rightarrow H_*(F(R), Hom).$$

Here $M(R) = \text{colim } M_n(R)$ and the group $GL(R) = \text{colim } GL_n(R)$ acts by conjugation on $M(R)$. Moreover both homomorphisms are obtained as the colimit of the homomorphisms

$$H_*(GL_n(R), \mathbf{Z}) \rightarrow H_*(GL_n(R), M_n(R))$$

and

$$H_*(GL_n(R), M_n(R)) \rightarrow H_*(F(R), Hom).$$

The first one is induced by the homomorphism of coefficients $\mathbf{Z} \rightarrow M_n(R)$ which sends 1 to the identity matrix. In order to describe the second homomorphism one considers the group $GL_n(R)$ as a ‘one object category’ and $M_n(R)$ as a bifunctor on it (using multiplication of matrices). There is an obvious functor from this one object category to $F(R)$ sending the unique object to R^n . It yields the homomorphism $H_*(\mathbf{Z}[GL_n(R)], M_n(R)) \rightarrow H_*(F(R), Hom)$ and the expected homomorphism is obtained by composition with the Mac Lane isomorphism of Proposition 7.4.2. One needs to check that the different homomorphisms

$$H_*(GL_n(R), M_n(R)) \rightarrow H_*(F(R), Hom)$$

are compatible when passing from n to $n + 1$. This can be seen by using the homotopies $s_k = \sum_{i=0}^n (-1)^i h_i^k$ in the chain complex $C_*(F(R), Hom)$, where the homomorphism h_i^k sends the component

$$\lambda = (A_0 \xrightarrow{\lambda_1} \dots \xrightarrow{\lambda_k} A_k)$$

to the component

$$A_0 \xrightarrow{\lambda_1} \dots \xrightarrow{\lambda_i} A_i \xrightarrow{(1,0)} A_i \oplus R \xrightarrow{\lambda_{i+1} \oplus 1} \dots \xrightarrow{\lambda_k \oplus 1} A_k \oplus R.$$

Moreover the restriction of h_i^k to the component λ is the canonical inclusion $Hom(A_k, A_0) \rightarrow Hom(A_k \oplus R, A_k)$.

13.1.9 Proposition. *For any ring R the Dennis trace map Dtr is the composite*

$$Dtr = \alpha_* \circ DTr : H_*(GL(R), \mathbf{Z}) \rightarrow H_*(F(R), Hom) \rightarrow HH_*(R).$$

Proof. All the homomorphisms are explicit, so it is immediate by checking on GL_n . □

Exercises

E.13.1.1 For any abelian group A define an abelian group $P_2(A)$ with generators $p(a)$ for any $a \in A$ modulo the following relations

$$p(a + b + c) - p(a + b) - p(a + c) - p(b + c) + p(a) + p(b) + p(c) = 0.$$

Show that there exists an exact sequence in $\mathcal{F}(\mathbf{Z})$:

$$0 \longleftarrow Id \longleftarrow P_2 \longleftarrow \otimes^2 \longleftarrow \bar{\Lambda}^2 \longleftarrow Id/2 Id \longleftarrow 0.$$

Here $\bar{\Lambda}^2(X) = X \otimes X / \{x \otimes y + y \otimes x\}$. Prove that the above exact sequence gives the generator for $Ext_{\mathcal{F}(\mathbf{Z})}^2(\mathbf{Z}, \mathbf{Z}/2\mathbf{Z}) = \mathbf{Z}/2\mathbf{Z}$. Use the results of E.13.1.4 and E.13.1.5 below (see Pirashvili [1993]).

E.13.1.2 Let $f : A \rightarrow B$ be a map between two abelian groups which maps 0 to 0. The *cross-effects* of f are defined by

$$(a_1 | a_2)_f := f(a_1 + a_2) - f(a_1) - f(a_2),$$

and more generally, on $n + 1$ variables, by

$$(a_1 | \dots | a_{n+1})_f := (a_1 | \dots | a_n + a_{n+1})_f - (a_1 | \dots | a_n)_f - (a_1 | \dots | a_{n-1} | a_{n+1})_f$$

A map $f : A \rightarrow B$ is called *polynomial of degree $\leq n$* if

$$(a_1 | \dots | a_{n+1})_f = 0,$$

for each $a_i \in A, i = 1, \dots, n + 1$. Show that, if $f : A \rightarrow B$ is a polynomial map of degree n , then

$$F(a) := \sum_{i=1}^n (-1)^i \frac{\Psi(n)}{i} \binom{n}{i} f(ia)$$

defines a homomorphism of abelian groups $F : A \rightarrow B$. Here $\Psi(n) = l.c.m.\{1, \dots, n\}$.

(Hint: use the following identities :

$$\sum_{i=k}^n (-1)^i \frac{1}{i} \binom{n}{i} \binom{i}{k} \binom{i}{j} = \frac{1}{j} \binom{n}{k} \sum_{i=k}^n (-1)^i \binom{n-k}{i-k} \binom{i-1}{j-1} = 0$$

where $1 \leq j \leq k \leq n$ and $k + j \leq n$.)

E.13.1.3 A functor $T : \mathbf{A} \rightarrow \mathbf{B}$ between additive categories with $T(0) = 0$ is called *polynomial of degree $\leq n$* if for any objects A_1, A_2 of \mathbf{A} the map

$$Hom_{\mathbf{A}}(A_1, A_2) \rightarrow Hom_{\mathbf{B}}(TA_1, TA_2)$$

given by $f \mapsto T(f)$ is polynomial of degree $\leq n$. We denote by $\mathcal{P}_n(R)$ the category of polynomial functors

$$T : F(R) \longrightarrow R\text{-Mod}$$

of degree less or equal to n . Prove that $\mathcal{P}_n(R)$ is an abelian category with sufficiently many projective and injective objects. The natural embedding $\mathcal{P}_n(R) \hookrightarrow \mathcal{F}(R)$ induces natural maps:

$$\alpha_n^* : Ext_{\mathcal{P}_n(R)}^*(R, M) \rightarrow Ext_{\mathcal{F}(R)}^*(R, M).$$

Prove that α_n^i is an isomorphism for $i \leq 2n$, provided that R is a torsion free abelian group (see Pirashvili [1993]).

(Hint: Let $P_n(A) := I(A)/I^{n+1}(A)$, where A is a free abelian group and $I(A)$ is the augmentation ideal of the group ring of A . Then P_n is a polynomial functor of degree n , which can be used to construct the projective generators in $\mathcal{P}_n(R)$. Use the fact that $\pi_i(I^{n+1}(K(A, m))) = 0$, when $i < m + 2n$ and $m > 1$.)

E.13.1.4 Show that, for any $T \in \mathcal{P}_n$ and any $0 < i \leq 2n$, the multiplication map by $\Psi(n)$ (see E.13.1.3) is zero on $HML^i(\mathbf{Z}, T)$.

(Hint. Use E.13.1.4 and the fact that there is a natural epimorphism: $\sigma : P_n \rightarrow I$ given by $\sigma(p_n a) = a$. Then apply E.13.1.3 to the polynomial map of degree n

$$p_n : A \rightarrow P_n(A),$$

where $p_n(a) = (a - 1) \text{ mod } I^{n+1}(A), a \in A$.)

E.13.1.5 A quadratic \mathbf{Z} -module

$$M_e \xrightarrow{H} M_{ee} \xrightarrow{P} M_e$$

is a pair of abelian groups M_e and M_{ee} , together with homomorphisms P and H satisfying

$$PHP = 2P \text{ and } HPH = 2H.$$

Prove that the category of quadratic \mathbf{Z} -modules is equivalent to $\mathcal{P}_2(\mathbf{Z})$ (see Baues [1994]) and that

$$Ext_{\mathcal{P}_2(\mathbf{Z})}^*(\mathbf{Z}, \mathbf{Z}) \cong \mathbf{Z}[\eta]/2\eta$$

where $deg \eta = 4$ (see Pirashvili [1993]).

E.13.1.6. Let \mathbf{A} be a small additive category. We let $CML_*(\mathbf{A})$ denote the chain complex of \mathbf{A} , with coefficients in the bifunctor Hom , as defined in the Appendix C. So, one has

$$CML_0(\mathbf{A}) := \bigoplus_{X \in Ob \mathbf{A}} Hom(X, X),$$

where the sum is extended over all objects of \mathbf{A} and more generally:

$$CML_n(\mathbf{A}) := \bigoplus_{X_0 \rightarrow \dots \rightarrow X_n} Hom(X_n, X_0),$$

where the sum is extended over all the n -simplices of the nerve of \mathbf{A} . Hence, by definition one has $HML_*(\mathbf{A}) := H_*(CML_*(\mathbf{A}))$. For any endomorphism $f : X \rightarrow X$, we denote by $tr(f)$ the class of f in $HML_0(\mathbf{A})$. Show that

$tr(f + g) = tr(f) + tr(g)$ and $tr(fg) = tr(gf)$, when it has a meaning. Prove that tr is the universal map with those properties. Prove that $X \mapsto tr(1_X)$ yields a well-defined map $K_0(\mathbf{A}) \rightarrow HML_0(\mathbf{A})$. Extend this homomorphism in higher dimensions (see Pirashvili [1989]).

E.13.1.7 Let \mathbf{A} be a small additive category. We recall that in E.2.5.2 we defined a simplicial (even cyclic) abelian group $C_*(\mathbf{A})$. We let $H_*(\mathbf{A})$ denote the homology of $C_*(\mathbf{A})$. Define the natural chain epimorphism $CML_*(\mathbf{A}) \rightarrow C_*(\mathbf{A})$. Prove that for $\mathbf{A} = F(R)$, this gives an alternative description of α_* as constructed in 13.1.3.

E.13.1.8. Notation as above. Let $M : \mathbf{A}^{op} \times \mathbf{B} \rightarrow Ab$ be an additive bifunctor, where \mathbf{A} and \mathbf{B} are additive categories. Define the category $\mathbf{C} = \begin{pmatrix} \mathbf{A} & 0 \\ M & \mathbf{B} \end{pmatrix}$ with set of objects $Ob(\mathbf{A}) \times Ob(\mathbf{B})$, while morphisms from (X, Y) to (X', Y') are matrices $\begin{pmatrix} f & 0 \\ m & g \end{pmatrix}$, where $X, X' \in Ob(\mathbf{A}); Y, Y' \in Ob(\mathbf{B})$, and $f \in \mathbf{A}(X, X'), g \in \mathbf{B}(Y, Y'), m \in M(X, Y')$. The composition is given by the multiplication of matrices. Show that

$$H_*(\mathbf{C}) \cong H_*(\mathbf{A}) \oplus H_*(\mathbf{B}) \text{ and so } HML_*(\mathbf{C}) \cong HML_*(\mathbf{A}) \oplus HML_*(\mathbf{B})$$

(compare with theorem 1.2.15, see also Dundas-McCarthy [1994]).

13.2 Mac Lane (co)homology

In this section we introduce Mac Lane (co)homology of a ring R as the (co)homology of a certain differential graded ring $Q_*(R)$. The complex $Q_*(R)$, given by the cubical construction of Eilenberg and Mac Lane, is a good algebraic model for the homology of Eilenberg and Mac Lane spectra. If R contains the rational numbers, then Mac Lane (co)homology coincides with Hochschild (co)homology. We prove the equivalence with the (co)homology of $F(R)$ with coefficients in Hom , whence the equivalence with Ext and Tor groups over $\mathcal{F}(R)$ introduced in the first section.

A key role is played by a peculiar functor t from the small category of finite pointed sets to abelian groups (cf. 13.2.4).

13.2.1 Eilenberg-Mac Lane’s cubical construction. The cubical construction of Eilenberg and Mac Lane assigns functorially a chain complex of abelian groups $Q_*(A)$ to any abelian group A . This complex has the following property:

13.2.2 Theorem. *The homology of $Q_*(A)$ is isomorphic to the stable homology of the Eilenberg and Mac Lane spaces:*

$$H_n(Q_*(A)) \cong H_{n+k}(K(A, k)), \quad k \geq n + 1.$$

We first construct $Q_*(A)$, then we prove a few lemmas before giving the proof of theorem 13.2.2.

Recall that the Eilenberg-Mac Lane space $K(A, k)$ is a topological abelian group (or equivalently a simplicial abelian group), whose homotopy groups are trivial except for π_k which is precisely A . For a more general result see E.13.2.2 which describes, as a particular case, the homology of a spectrum associated to a Γ -space in terms of a generalized cubical construction.

The complex $Q_*(A)$ is obtained by some normalization process from an auxiliary chain complex $Q'_*(A)$ described below:

$$Q_*(A) := Q'_*(A)/N_*(A).$$

In low dimensions $Q'_*(A)$ and $N_*(A)$ look as follows:

$$Q'_0(A) = \mathbf{Z}[A], \quad Q'_1(A) = \mathbf{Z}[A^2], \quad Q'_2(A) = \mathbf{Z}[A^4].$$

The generators of $\mathbf{Z}[A]$, $\mathbf{Z}[A^2]$ and $\mathbf{Z}[A^4]$ are denoted by (a) , (a, b) and $\begin{pmatrix} a & b \\ c & d \end{pmatrix}$ respectively. The boundary map acts on the generators by

$$d(a, b) = (a) + (b) - (a + b),$$

$$d\begin{pmatrix} a & b \\ c & d \end{pmatrix} = (a, b) + (c, d) - (a + c, b + d) - (a, c) - (b, d) + (a + b, c + d).$$

The subcomplex $N_*(A)$ is generated by the following generators:

$$(0); \quad (a, 0), \quad (0, a); \quad \begin{pmatrix} 0 & 0 \\ c & d \end{pmatrix}, \quad \begin{pmatrix} a & b \\ 0 & 0 \end{pmatrix}, \quad \begin{pmatrix} 0 & b \\ 0 & d \end{pmatrix}, \quad \begin{pmatrix} a & 0 \\ c & 0 \end{pmatrix}.$$

In order to describe it in higher dimensions, we fix the following notation. Let C_n denote the set of vertices of the n -dimensional unit cube. The elements of C_n can be described as sequences $(\epsilon_1, \dots, \epsilon_n)$, where $\epsilon_i = 0$ or 1 , for $n \geq 1$. If $n = 0$, then the unique element of C_n is denoted by $(\)$. Define the maps

$$0_i, 1_i : C_n \rightarrow C_{n+1}$$

for $1 \leq i \leq n + 1$, by the equalities

$$\begin{aligned} 0_i(\epsilon_1, \dots, \epsilon_n) &= (\epsilon_1, \dots, \epsilon_{i-1}, 0, \epsilon_i, \dots, \epsilon_n), \\ 1_i(\epsilon_1, \dots, \epsilon_n) &= (\epsilon_1, \dots, \epsilon_{i-1}, 1, \epsilon_i, \dots, \epsilon_n). \end{aligned}$$

For any abelian group A and any set S , let $A[S]$ denote the direct sum of $|S|$ copies of the group A indexed by S . Since the set C_n is finite, the group $A[C_n]$ can be identified with the group of all maps $x : C_n \rightarrow A$. Let $Q'_n(A)$ be the free abelian group generated by the set $A[C_n]$, i.e.,

$$Q'_n(A) = \mathbf{Z}[A[C_n]].$$

Define for $i = 1, 2, \dots, n$ the maps

$$\bar{P}, \bar{S}, \bar{R} : A[C_n] \rightarrow A[C_{n-1}]$$

as follows:

$$(\bar{R}x)(e) = x(0_i e); (\bar{S}x)(e) = x(1_i e); (\bar{P}x)(e) = x(0_i e) + x(1_i e).$$

Here $e \in C_{n-1}$ and $x \in A[C_n]$. Thus \bar{S}_i is the restriction to the i th upper face, \bar{R}_i is the restriction on the i th lower face, while \bar{P}_i adds the i th upper face vertexwise to the i th lower face. Now we put

$$R_i = \mathbf{Z}[\bar{R}_i], S_i = \mathbf{Z}[\bar{S}_i], P_i = \mathbf{Z}[\bar{P}_i],$$

which are homomorphisms $R_i, S_i, P_i : Q'_n(A) \rightarrow Q'_{n-1}(A)$. Let $\partial : Q'_n(A) \rightarrow Q'_{n-1}(A)$ be the homomorphism given by

$$\partial = \sum_{1 \leq i \leq n} (-1)^i (P_i - R_i - S_i).$$

Then $\partial^2 = 0$ and we get the chain complex $Q'_*(A)$.

A generator $x : C_n \rightarrow A$ of the group $Q'_n(A)$ is a *slab* when $x() = 0$, for $n = 0$, and an *i -slab*, $i = 1, \dots, n$, for $n \geq 1$, if either $x(0_i e) = 0$ for all $e \in C_{n-1}$ or $x(1_i e) = 0$ for all $e \in C_{n-1}$.

Let $N_n(A)$ denote the subgroup of $Q'_n(A)$ generated by all the slabs. It is easily seen that $N_*(A)$ is a subcomplex of $Q'_*(A)$ and hence the quotient $Q_*(A) = Q'_*(A)/N_*(A)$ is a well-defined complex. We remark that $N_*(A)$ is not acyclic, so $Q_*(A)$ and $Q'_*(A)$ have different homology in general.

In order to prove theorem 13.2.2 one needs to introduce a set-version of the above constructions, following Pirashvili [1996].

13.2.3 Cubical construction for sets. Recall that Fin_* denotes the category of finite pointed sets (cf. 6.4.1). For any set S , we denote by S_+ the pointed set which is obtained from S by adding a distinguished point denoted $+$. Moreover we denote by $|S|$ the cardinality of S .

For each $X_+ \in Fin_*$ and $n \geq 0$, we define a chain complex $SQ'_*(X_+)$ and its subcomplex $SN_*(X_+)$ as follows. Let $B_1(X)$ be the set of subsets of X . More generally, define $B_k(X)$ as the set of all sequences (S_1, \dots, S_k) , where $S_i, i = 1, \dots, k$ are pairwise disjoint subsets of X . Now we put:

$$SQ'_0(X_+) = \mathbf{Z}[B_1(X)], SQ'_1(X_+) = \mathbf{Z}[B_2(X)], SQ'_2(X_+) = \mathbf{Z}[B_4(X)], \dots$$

The generators in $\mathbf{Z}[B_1(X)]$, $\mathbf{Z}[B_2(X)]$ and $\mathbf{Z}[B_4(X)]$ are denoted by (S) , (S, T) and $\begin{pmatrix} S & T \\ U & V \end{pmatrix}$ respectively, where $S, T, U, V \subset X$. The boundary map acts on the generators by

$$d(S, T) = (S) + (T) - (S \cup T),$$

$$d \begin{pmatrix} S & T \\ U & V \end{pmatrix} = (S, T) + (U, V) - (S \cup U, T \cup V) - (S, U) - (T, V) + (S \cup T, U \cup V).$$

The subcomplex $SN_*(X_+)$ is generated by the following generators:

$$(\emptyset); (S, \emptyset), (\emptyset, S); \begin{pmatrix} \emptyset & \emptyset \\ U & V \end{pmatrix}, \begin{pmatrix} S & T \\ \emptyset & \emptyset \end{pmatrix}, \begin{pmatrix} \emptyset & T \\ \emptyset & V \end{pmatrix}, \begin{pmatrix} S & \emptyset \\ U & \emptyset \end{pmatrix}.$$

We leave to the reader, as an exercise, the task of describing SQ'_* and $SN_*(A)$ in higher dimensions by using higher dimensional cubes (see Pirashvili [1996]).

As for abelian groups, one defines

$$SQ_*(X_+) := SQ'_*(X_+)/SN_*(X_+).$$

13.2.4 The functor t . Let $t : Fin_*^{op} \rightarrow Ab$ be given as follows:

$$t(X_+) = \mathbf{Z}[X], \quad t(f)(y) = \sum_{f(x)=y} x.$$

Here X and Y are finite sets, $x \in X$, $y \in Y$, $f \in Fin_*(X_+, Y_+)$. The same functor may be described by

$$t(X_+) = Fin_*(X_+, \mathbf{Z}).$$

13.2.5 Lemma. $H_i(SQ_*(X_+)) = 0$ for $i \geq 1$ and $H_0(SQ_*(X_+)) = t(X_+)$.

Proof. The proof is obvious when $Card X = 1$. Since $t(X_+ \vee Y_+) \cong t(X_+) \oplus t(Y_+)$ it remains to show

$$H_*(SQ_*(X_+ \vee Y_+)) \cong H_*(SQ_*(X_+)) \oplus H_*(SQ_*(Y_+)).$$

The following complex $SQ_*(X) \oplus SQ_*(Y)$ is a direct summand of the complex $Q_*(X_+ \vee Y_+)$, because $SQ_*(*) = 0$, and thus one needs to construct a homotopy between the identity morphism of $Q_*(X_+ \vee Y_+)$ and the corresponding retraction. In low dimensions this homotopy is :

$$h(S) = (S \cap X, S \cap Y),$$

$$h((S, T)) = \begin{pmatrix} S \cap X & S \cap Y \\ T \cap X & T \cap Y \end{pmatrix}.$$

13.2.6 Lemma. *The projections $Q'_* \rightarrow Q_*$ and $SQ'_* \rightarrow SQ_*$ have natural sections.*

Proof. The argument in both cases is the same. Corresponding sections in low dimension for abelian groups are induced by

$$(a) \mapsto (a) - (0);$$

$$(a, b) \mapsto (a, b) - (a, 0) - (0, b) + (0, 0).$$

We let to the reader, as an exercise, the task of describing the sections and the homotopies in Lemma 13.2.6 and Lemma 13.2.5 in higher dimensions (see Jiblaze-Pirashvili [1991] and Pirashvili [1996]). \square

Proof of the Theorem 13.2.2. Let \mathcal{A} be the category of contravariant functors from Fin_* to the category of abelian groups. This is an abelian category with enough projective (and injective) objects. For any set S , we define a functor

$$h_S : (Fin_*)^{op} \rightarrow Ab$$

by $h_S(X_+) = \mathbf{Z}[Fin_*(X_+, S_+)]$. So $h_S(X_+)$ is a free abelian group generated by $|S|$ pairwise disjoint subsets of X . Thanks to the Yoneda Lemma each functor h_S is a projective object in \mathcal{A} . We remark that $SQ'_n \cong h_S$, with $|S| = 2^n$. So SQ'_n , as well as SQ_n , are projective in \mathcal{A} , by Lemma 13.2.6. Moreover, by Lemma 13.2.5, SQ_* is a projective resolution of $t \in \mathcal{A}$. Let ab be the category of finitely generated abelian groups. Obviously t has values in ab . Composition with t yields a functor $Ab^{ab} \rightarrow \mathcal{A}$, which has a left adjoint functor $t_! : \mathcal{A} \rightarrow Ab^{ab}$ known as *left Kan extension* of t . So $t_!$ is a right exact functor. Moreover it preserves the direct sums and

$$(13.2.6.1) \quad t_!(h_S)(A) = \mathbf{Z}[\mathbf{Z}[S] \otimes A].$$

This shows that $t_!(SQ'_*) = Q'_*$ as well as $t_!(SQ_*) = Q_*$. Therefore we get the following isomorphism:

$$(13.2.6.2) \quad (L_n t_!)(t)(A) \cong H_n(Q_*(A)).$$

Here $L_* t_!$ denotes, as usual, the left derived functors of the functor $t_!$. Now we use another projective complex in \mathcal{A} to finish the proof. Let S^k be a simplicial model of the pointed k -dimensional sphere with finitely many simplices in each dimension. For any $X_+ \in Fin_*$, we consider the reduced chains of the simplicial set $Fin_*(X_+, S^k)$, which is nothing but the product of $|X|$ copies of S^k . By varying X_+ we obtain a chain complex in \mathcal{A} , whose components have the form h_S , for suitable S , and hence are projective objects in \mathcal{A} . Moreover, the homology of this complex in dimension $< 2k$ is zero, except in dimension k , where it is isomorphic to t . Therefore, in order to compute $L_n t_!(t)$, one can use this complex, for $k > n$. By (13.2.6.1) the functor $t_!$ sends this complex to the reduced chains of $\mathbf{Z}[S^k] \otimes A$. Since $\mathbf{Z}[S^k] \otimes A$ has a $K(A, k)$ -type we have

$$(13.2.6.3) \quad (L_n t_!)(t)(A) \cong H_{n+k}(K(A, k)), \quad n \leq k - 1.$$

By comparing the two calculations (13.2.6.2) and (13.2.6.3) of $(L_n t_!)(t)$ we get the result. \square

13.2.7 Dixmier Product and augmentation. Define an augmentation

$$\eta : Q_*(A) \rightarrow A$$

by $\eta x = 0$ if x is a positive degree generator, and by $\eta x = x()$ for the generator x of degree zero. For any abelian groups A and B there is a product map

$$Q_*(A) \otimes Q_*(B) \rightarrow Q_*(A \otimes B)$$

with nice coherence properties. This product is defined by

$$(xu)(\epsilon_1, \dots, \epsilon_{n+m}) = x(\epsilon_1, \dots, \epsilon_m)u(\epsilon_{m+1}, \dots, \epsilon_{m+n}).$$

Here $x \in A[C_m]$, $u \in B[C_n]$ and $\epsilon_i = 0$ or 1 , $1 \leq i \leq m + n$. When R is a ring, the Dixmier product equips $Q_*(R)$ with the structure of a differential graded (DG) ring. Observe that, if R is concentrated in degree zero, then η is a morphism of DG rings. When M is a module over R , then $Q_*(M)$ has a natural $Q_*(R)$ -module structure. As a particular case we obtain the fact that R has a natural bimodule structure over $Q_*(R)$.

13.2.8 Definition of Mac Lane (co)homology. The *Mac Lane cohomology* of a ring R with coefficients in the bimodule M is defined as Hochschild cohomology of the DG ring $Q_*(R)$ with coefficients in the bimodule M :

$$HML^*(R, M) := H^*(Q_*(R), M)$$

and the *Mac Lane homology* of a ring R with coefficients in the bimodule M is defined as Hochschild homology of the DG ring $Q_*(R)$ with coefficients in the bimodule M :

$$HML_*(R, M) := H_*(Q_*(R), M).$$

In the case $M = R$, the Mac Lane homology $HML_*(R, R)$ is simply denoted by $HML_*(R)$.

A definition of Mac Lane (co)homology in terms of coptriples can be found in McCarthy [1997].

13.2.9 Relationship with Hochschild theory. The augmentation $\eta : Q_*(R) \rightarrow R$ induces a natural map from Mac Lane homology to Hochschild homology and from Hochschild cohomology to Mac Lane cohomology:

$$\eta_* : HML_*(R, M) \rightarrow H_*(R, M), \quad \eta^* : H^*(R, M) \rightarrow HML^*(R, M).$$

It follows from the properties of the Eilenberg-Mac Lane spaces that

$$H_0(Q_*(R)) = R, \quad H_1(Q_*(R)) = 0.$$

Thus η_* and η^* are isomorphisms for $*$ = 0, 1. Moreover if R is an algebra over the rational numbers, then $H_i(Q_*(R)) = 0$, for $i \geq 1$ and hence η_* and η^* are isomorphisms in each dimension. However η_2 (resp. η^2) is generally only an epimorphism (resp. monomorphism). See also Exercise E.13.2.7.

13.2.10 Theorem (*Ext-interpretation of Mac Lane cohomology, Jibladze-Pirashvili [1991]*). For any ring R , and any R -bimodule M one has a natural isomorphism:

$$HML^*(R, M) \cong Ext_{\mathcal{F}(R)}^*(I, M \otimes_R -).$$

This is the analogue of the isomorphism 1.5.8. Note that the modification consists in taking *Ext* groups, not in the category of bimodules i.e. of additive functors, but in the larger category $\mathcal{F}(R)$ of non-additive bimodules. Theorem 13.2.10 motivates the following

13.2.11 Definition. The *Mac Lane cohomology* of an associative ring R with coefficients in an arbitrary functor $T \in Ob \mathcal{F}(R)$ is defined by

$$HML^*(R, T) := Ext_{\mathcal{F}(R)}^*(I, T).$$

In order to prove the theorem one needs some additional results. Recall that, when X and Y are left and right modules over a DG ring Λ , their two-sided bar construction $B(X, \Lambda, Y)$ is defined by

$$B(X, \Lambda, Y) := \sum X \otimes \Lambda^{\otimes n} \otimes Y.$$

13.2.12 Lemma. Let V be a finitely generated free left R -module. The composition

$$B(R, Q_*(R), Q_*(V)) \rightarrow B(R, R, V) \rightarrow V$$

induced by the augmentation maps $Q_*(R) \rightarrow R$ and $Q_*(V) \rightarrow V$ is a quasi-isomorphism.

Proof. If $V = R$, the Lemma is a consequence of well-known properties of the two-sided bar-construction (1.1.12 is a particular case, see Exercise E.13.2.5). The general result follows from this because $Q_*(V)$ is additive up to quasi-isomorphism, which is a consequence of Theorem 13.2.2 (it can be proved also by using the same argument as in Lemma 13.2.5). \square

13.2.13 Lemma. The functors

$$Q_n, Q'_n : F(R) \longrightarrow Ab$$

are projective objects of the category of all functors from $F(R)$ to Ab .

Proof. Recall that, by definition, for any R -module X one has:

$$Q'_n(X) = \mathbf{Z}[X[C_n]].$$

The functor $X \mapsto X[C_n]$ is representable since $X[C_n] = Hom_R(R^{2^n}, X)$. So projectivity of Q'_n follows from the Yoneda Lemma. By Lemma 13.2.6 Q_n is also projective. \square

13.2.14 Lemma. Let \mathcal{E} be the category of functors from $F(R)$ to the category of abelian groups and let T be an additive functor in \mathcal{E} . Then

$$Hom_{\mathcal{E}}(Q_i, T) = 0, \text{ for } 1 \leq i \leq n,$$

$$Hom_{\mathcal{E}}(Q_0, T) = T(R).$$

Proof. By definition one has an exact sequence of functors

$$\mathbf{Z} \rightarrow \mathbf{Z}[Hom_R(R, -)] \rightarrow Q_0 \rightarrow 0,$$

where the first map sends the generator to the trivial homomorphism. Hence $Hom_{\mathcal{E}}(Q_0, T) = T(R)$ thanks to the Yoneda Lemma. Similarly, by definition, one has an exact sequence of functors

$$\bigoplus \mathbf{Z}[Hom_R(R^{2^{i-1}}, -)] \rightarrow \mathbf{Z}[Hom_R(R^{2^i}, -)] \rightarrow Q_i \rightarrow 0,$$

where the sum is taken over all $(i - 1)$ -dimensional faces of i -dimensional cubes. Hence for $i > 0$ one has

$$Hom_{\mathcal{E}}(Q_i, T) = Ker(T(R^{2^i}) \rightarrow T(R^{2^{i-1}})) = 0$$

again thanks to the Yoneda Lemma. □

Proof of theorem 13.2.11. Lemma 13.2.13 implies that

$$B(R, Q_*(R), Q_*(-)) \rightarrow I$$

is a resolution. According to Lemma 13.2.6 this is indeed a *projective* resolution of $\mathcal{F}(R)$. So one has

$$\begin{aligned} Ext^*(I, T) &= H^*(Hom(B(R, Q_*(R), Q_*(-)), T)) = \\ &= H^*(Hom_{R-R}(B(R, Q_*(R), R), T)) = H^*(R, M), \end{aligned}$$

where Ext and Hom are taken in $\mathcal{F}(R)$. The second isomorphism is a consequence of Lemma 13.2.14. □

13.2.15 For interpretation of Mac Lane homology. There is a well-known notion of tensor product of functors. One defines the *Tor* groups on small categories as the left derived functor of this tensor functor (cf. Appendix C). Let

$$I^* : (F(R))^{op} \rightarrow Mod-R$$

be the functor given by $I^*(X) = Hom_R(X, R)$. Then the same argument as in the proof of Lemma 13.2.13 shows that

$$B(Q(X^*), Q(R), R) \longrightarrow X^*$$

is a quasi-isomorphism. By varying X we obtain the projective resolution

$$B(Q((-)^*), Q(R), R) \longrightarrow I^* .$$

Then by the same argument as in Theorem 1.13.21, we obtain the following

13.2.16 Theorem. *For any bimodule M over the ring R there is a canonical isomorphism*

$$HML_*(R, M) \cong Tor_*^{F(R), R}(I^*, M \otimes_R -).$$

□

13.2.17 Definition. As for cohomology, this isomorphism allows us to define the *Mac Lane homology of a ring R with coefficients in the functor $T \in \mathcal{F}(R)$* , by

$$H_*(R, T) := \text{Tor}_*^{F(R), R}(I^*, T).$$

Exercises

E.13.2.1 A generator $x : C_n \rightarrow A$ is *i -diagonal* if $x(\epsilon_1, \dots, \epsilon_n) = 0$ for all $(\epsilon_1, \dots, \epsilon_n)$ with $\epsilon_i \neq \epsilon_{i+1}$. Here $n \geq 2$, $1 \leq i < n$. Prove that if one kills all diagonal elements in $Q_*(A)$, then one gets a complex which is homotopically equivalent to $Q_*(A)$. (Note that the complex denoted by $Q_*(A)$ in Mac Lane [1956], Jibladze-Pirashvili [1991] and Pirashvili [1996] is in fact the quotient by diagonal elements).

E.13.2.2 For $1 \leq i \leq n$, we let $p_i, r_i, s_i : (C_n)_+ \rightarrow (C_{n-1})_+$ denote the following morphisms in Fin_* :

$$\begin{aligned} s_i(\epsilon_1, \dots, \epsilon_{i-1}, 0, \epsilon_{i+1}, \dots, \epsilon_n) &= (\epsilon_1, \dots, \epsilon_{i-1}, \epsilon_{i+1}, \dots, \epsilon_n), \\ s_i(\epsilon_1, \dots, \epsilon_{i-1}, 1, \epsilon_{i+1}, \dots, \epsilon_n) &= +, \\ r_i(\epsilon_1, \dots, \epsilon_{i-1}, 0, \epsilon_{i+1}, \dots, \epsilon_n) &= +, \\ r_i(\epsilon_1, \dots, \epsilon_{i-1}, 1, \epsilon_{i+1}, \dots, \epsilon_n) &= (\epsilon_1, \dots, \epsilon_{i-1}, \epsilon_{i+1}, \dots, \epsilon_n), \\ p_i(\epsilon_1, \dots, \epsilon_i, \dots, \epsilon_n) &= (\epsilon_1, \dots, \epsilon_{i-1}, \epsilon_{i+1}, \dots, \epsilon_n). \end{aligned}$$

For any functor $T : Fin_* \rightarrow Ab$ define the chain complexes $Q'_*(T)$ and $Q_*(T)$ analogous to $Q'_*(A)$ and $Q_*(A)$ as follows :

$$Q'_n(T) := T([C_n]_+), \quad n \geq 0,$$

while the boundary map is given by

$$\partial = \sum_{1 \leq i \leq n} (-1)^i (T(p_i) - T(r_i) - T(s_i)).$$

Note that, if $T(X_+) = \mathbf{Z}[Hom(t(X_+), A)]$, then $Q_*(T)$ coincides with $Q_*(A)$. Prove that one has isomorphisms

$$\text{Tor}_q^{Fin_*}(t, T) \cong H_q(Q_*(T)) \cong \pi_{n+q}(T(S^n)) \quad \text{if } q < n,$$

where S^n is a simplicial model of the pointed n -dimensional sphere, with finitely many simplices in each dimension (this is a generalization of theorem 13.2.2).

E.13.2.3 Let R be a ring, for a fixed R -bimodule M one considers the set of equivalence classes of all abelian (not necessarily split as abelian groups) extensions of R by M for which the R -bimodule structure of M is the prescribed

one. One denotes this set $Extrings(R, M)$. Show that one has a canonical bijection

$$HML^2(R, M) \cong Extrings(R, M)$$

(see Mac Lane [1956]).

E.13.2.4 From the previous exercise and E.1.5.1 one could think that the set of components of the category of all (not necessarily split as abelian groups) crossed bimodules $Cros'(R, M)$ and $HML^3(R, M)$ are in bijection. Show that there is a natural monomorphism:

$$Cros'(R, M) \rightarrow HML^3(R, M).$$

Show that it is not a bijection in general.

E.13.2.5 Show that $H_0B(X, \Lambda, Y) \cong X \otimes_{\Lambda} Y$. Assume Λ, X and Y are torsion free, then prove that

$$H_*B(X, \Lambda, Y) \cong Tor_*^{\Lambda}(X, Y).$$

13.3 Stable K -theory and Mac Lane homology

We start with the definition of stable K -theory of discrete rings via Quillen's plus-construction and we show how this theory comes into the computation of the homology of the general linear group with matrix coefficients. Then we give the proof of B.I. Dundas and R. McCarthy [1994] of the following important theorem: stable K -theory of the ring R is isomorphic to the homology of the category of f. g. projective R -modules with coefficients in the bifunctor Hom . As we mentioned in the introduction (and proved in section 1) this is the same as Mac Lane homology of R . The proof requires the study of algebraic K -theory of simplicial rings and the S -construction of Waldhausen.

13.3.1 Stable K -theory of discrete rings. Let R be a ring and let N be an R -bimodule. Let $\mathcal{M}_k(N)$ be the bimodule of $k \times k$ -matrices over N . The linear group $GL_k(R)$ acts by conjugation on $\mathcal{M}_k(N)$. Since this action is compatible with stabilization we get an action of $GL(R)$ on $\mathcal{M}(N)$. Recall that, in $GL(R)$, a matrix A is identified with $\begin{pmatrix} A & 0 \\ 0 & 1 \end{pmatrix}$ while in $\mathcal{M}(N)$

it is identified with $\begin{pmatrix} A & 0 \\ 0 & 0 \end{pmatrix}$. It is important to know how to calculate the homology groups $H_*(GL(R), \mathcal{M}(N))$ of $GL(R)$ with twisted coefficients, at least in terms of the homology with constant coefficients. Stable K -theory

plays an important role to handle this problem. Following Friedhelm Waldhausen (see Kassel [1982]), we consider the homotopy fiber $\Psi(R)$ of the map $BGL(R) \rightarrow BGL(R)^+$. Since the group $\pi_1\Psi(R) = St(R)$ (Steinberg group, cf. 11.1.7) acts on $\mathcal{M}(N)$ via $GL(R)$, we may consider $\mathcal{M}(N)$ as a local coefficient system on the space $\Psi(R)$.

By definition *the stable K-theory of R with coefficients in the bimodule N* is the homology of $\Psi(R)$ with coefficients in the local coefficient system $\mathcal{M}(N)$:

$$K_n^s(R, N) := H_n(\Psi(R), \mathcal{M}(N)), \text{ for } n \geq 0.$$

13.3.2 Proposition. *There exists a spectral sequence*

$$E_{pq}^2 = H_p(GL(R), K_q^s(R, N)) \implies H_{p+q}(GL(R), \mathcal{M}(N)),$$

where $GL(R)$ acts trivially on $K_*^s(R, N)$.

Proof. The homotopy fibration

$$\Psi(R) \rightarrow BGL(R) \rightarrow BGL(R)^+$$

gives a Serre spectral sequence with abutment $H_*(BGL(R), \mathcal{M}(N)) = H_*(GL(R), \mathcal{M}(N))$. Since $\pi_1 BGL(R)^+ = K_1(R)$ acts trivially on $H_*(\Psi(R), \mathcal{M}(N))$ and since the $+$ -construction does not change the homology with trivial coefficients, the E_{pq}^2 -term of the spectral sequence is

$$E_{pq}^2 = H_p(BGL(R)^+, H_q(\Psi(R), \mathcal{M}(N))) = H_p(GL(R), K_q^s(R, N)).$$

□

This spectral sequence is a particular case of a more general one established by Kassel [1983]. One can show that this spectral sequence always degenerates at E^2 (see M. Bökstedt [1985b] and Betley - Pirashvili [1994]). So $H_*(GL(R), \mathcal{M}(N))$ is computable from the homology of $GL(R)$ with trivial coefficients $K_*^s(R, N)$. The following theorem computes stable K -theory from Mac Lane homology theory.

13.3.3 Theorem (Dundas and McCarthy [1994]). *For any ring R and any R-bimodule N there exists a natural isomorphism*

$$HML_*(R, N) \cong K_*^s(R, N).$$

The proof of this theorem is in two steps. The first one is the isomorphism $HML_*(R, N) \cong H_*(F(R), Hom(-, - \otimes_R N))$ due to Jibladze and Pirashvili (cf. section 1). The second one, due to Dundas and McCarthy, occupies the rest of this section and needs several auxiliary constructions, most of them having independent interest.

13.3.4 Algebraic K -theory for simplicial rings. Let R_* be a simplicial ring. The homotopy groups of the geometric realization of R_* can be calculated purely algebraically as follows. Consider the chain complex whose underlying graded abelian group is the same as R_* and the boundary map is the alternate sum of the face homomorphisms. The homotopy groups of $|R_*|$ are isomorphic to the homology groups of this complex and are denoted by $\pi_i R_*$. It is easy to check that $\pi_0 R_*$ has a natural ring structure and that the natural augmentation map $R_* \rightarrow \pi_0 R_*$ is a homomorphism of rings. Following Waldhausen [1978], one defines the simplicial monoid $\widehat{GL}_k(R_*)$ by the pull-back diagram :

$$\begin{array}{ccc} \widehat{GL}_k(R_*) & \longrightarrow & GL_k(\pi_0 R_*) \\ \downarrow & & \downarrow \\ M_k(R_*) & \longrightarrow & M_k(\pi_0 R_*) . \end{array}$$

Here $M_k(R_*)$ and $M_k(\pi_0 R_*)$ are considered as multiplicative monoids. So, by definition, elements of $\widehat{GL}_k(R_*)$ are matrices which are invertible up to homotopy. One has $\pi_1 B\widehat{GL}_k(R_*) = GL(\pi_0 R_*)$, so one can take Quillen's $+$ -construction to get a new space: $B\widehat{GL}_k(R_*)^+$.

By definition the *algebraic K -theory* of R_* is the space

$$K(R_*) := K_0(\pi_0 R_*) \times B\widehat{GL}_k(R_*)^+$$

and the homotopy groups of this space are the *algebraic K -groups* of the simplicial ring R_* :

$$K_i(R_*) := \pi_i(K(R_*)), \quad i \geq 0.$$

This construction is invariant with respect to weak equivalences. Moreover if $R_* \rightarrow R'_*$ is k -connected, meaning that it yields isomorphism on homotopy in dimensions $< k$ and epimorphism in dimension k , then $K_i(R_*) \rightarrow K_i(R'_*)$ is $k + 1$ -connected. This can be seen by using the commutative diagram

$$\begin{array}{ccc} M_k(R_{*(0)}) & \longrightarrow & M_k(R'_{*(0)}) \\ \downarrow & & \downarrow \\ \widehat{GL}_k(R_*)_{(e)} & \longrightarrow & \widehat{GL}_k(R'_*)_{(e)} \end{array}$$

where the subscript (0) , resp. (e) , denotes the zero and identity components respectively. Since the vertical maps are the isomorphisms given by the addition of 1, the result follows. This property shows that K -theory of simplicial rings is in general very far from the homotopy groups of the space obtained by the degreewise $+$ -construction. However these two approaches give the same result in the following situation. Recall that for any ring R and any R -bimodule N , one can construct the ring $R \oplus N$ with the following multiplication: $(r, n)(r', n') = (rr', rn' + nr')$. This construction has an obvious generalization for simplicial rings. As usual, for any abelian group A , one denotes by $K(A, m)$ the simplicial abelian group whose normalization

is nontrivial only in dimension m , where it is A . Usually we will identify a ring with its corresponding constant simplicial ring. Obviously if $m > 0$ and $S_* = R \oplus K(A, m)$, then $\widehat{GL}(S_*)$ is isomorphic to the group obtained by degreewise action of GL on S_* and $\widehat{BGL}(S_*)^+$ is homotopy equivalent to the degreewise $+$ -construction:

$$| [k] \mapsto BGL(S_k)^+ | .$$

13.3.5 Relative algebraic K -theory. For N_* a simplicial R_* -bimodule, let $\bar{K}(R_* \oplus N_*)$ denote the homotopy fiber of $K(R_* \oplus N_*) \rightarrow K(R_*)$. Let $\bar{K}_n(R_* \oplus N_*)$ be the n -th homotopy group of $\bar{K}(R_* \oplus N_*)$.

13.3.6 Proposition. *For any ring R and any R -bimodule N one has natural isomorphisms:*

$$\bar{K}_{i+1+m}(R \oplus K(N, m)) \cong K_i^s(R, N),$$

for $i \leq m - 1$.

Proof. Since $K(N, m)$ is a square zero ideal, there is a short exact sequence

$$0 \rightarrow \mathcal{M}(K(N, m)) \rightarrow \widehat{GL}(R \oplus K(N, m)) \rightarrow GL(R) \rightarrow 0,$$

which gives rise to a fibration

$$\mathcal{M}(K(N, m + 1)) \rightarrow \widehat{BGL}(R \oplus K(N, m)) \rightarrow BGL(R).$$

Consider the following commutative diagram of fibrations:

$$\begin{array}{ccccc} \mathcal{M}(K(N, m + 1)) & = & \mathcal{M}(K(N, m + 1)) & & \\ \downarrow & & \downarrow & & \\ U_m & \longrightarrow & \widehat{BGL}(R \oplus K(N, m)) & \longrightarrow & BGL(R)^+ \\ \downarrow & & \downarrow & & \parallel \\ \Psi(R) & \longrightarrow & BGL(R) & \longrightarrow & BGL(R)^+ . \end{array}$$

Since $\pi_1 U_m = \pi_1 \Psi(R) = St(R)$, one can perform the $+$ -construction on U_m . We claim that U_m^+ has the same homotopy type as $\bar{K}(R \oplus K(N, m))$. This follows from the Zeeman comparison theorem for the horizontal fibrations

$$\begin{array}{ccccc} U_m & \longrightarrow & \widehat{BGL}(R \oplus K(N, m)) & \longrightarrow & BGL(R)^+ \\ \downarrow & & \downarrow & & \parallel \\ \bar{K}(R \oplus K(N, m)) & \longrightarrow & \widehat{BGL}(R \oplus K(N, m))^+ & \longrightarrow & BGL(R)^+ \end{array}$$

and because $\pi_1 BGL(R)^+$ acts trivially on the homology of the fibres. Now we see that the spectral sequence for the first column and for the homology theory π_*^s (stable homotopy) has the form

$$E_{pq}^2 = H_p(\Psi(R), \pi_q^s(\mathcal{M}K(N, m + 1))) \implies \pi_{p+q}^s(U_m) = \pi_{p+q}^s(U_m^+).$$

By the Freudenthal theorem we have $\pi_q^s(\mathcal{M}K(N, m + 1)) = 0$ if $0 \leq q \leq m$ or $m + 1 < q \leq 2m$ and $\pi_{m+1}^s(\mathcal{M}K(N, m + 1)) \cong N$. Having this in mind,

the spectral sequence gives the isomorphisms $\pi_i^s(U_m^+) \cong 0$ for $i \leq m$ and $\pi_i^s(U_m^+) \cong H_{i-m-1}(\Psi(R), \mathcal{M}(N))$ for $m < i \leq 2m$. Hence

$$K_i^s(R, N) = H_i(\Psi(R), \mathcal{M}(N)) \cong \pi_{i+m+1}^s(U_m^+) \cong \pi_{i+m+1} \bar{K}(R \oplus K(N, m))$$

for $i \leq m - 1$. □

13.3.7 Waldhausen S -construction. In order to compare the relative K -theory with the homology of small categories, we need to introduce a new construction of the K -theory spaces. This technique, due to Waldhausen, is a variation of the Q -construction of Quillen.

By definition a *category with cofibrations* \mathcal{C} is a small category equipped with a subcategory $co\mathcal{C}$ (whose morphisms are called *cofibrations* and denoted \rightrightarrows) which satisfies the following axioms :

- (0) \mathcal{C} has a null object 0,
- (1) isomorphisms of \mathcal{C} are cofibrations,
- (2) for any object C of \mathcal{C} , $0 \rightrightarrows C$ is a cofibration,
- (3) for any pair of maps $B \leftarrow A \rightarrow C$ the push-out $B \cup_A C$ exists in \mathcal{C} and the resulting map $C \rightrightarrows B \cup_A C$ is a cofibration.

A functor between categories with cofibrations is called *exact* if it maps 0 to 0, cofibrations to cofibrations and push-out squares like (3) to push-out squares.

To any category with cofibrations one can associate a simplicial set $S\mathcal{C}$ as follows. An element of the set $S_n\mathcal{C}$ is a sequence of cofibrations $A_{00} \rightrightarrows A_{01} \rightrightarrows \dots \rightrightarrows A_{0n}$ such that $A_{00} = 0$. The i -th face consists in deleting the i -th object for $i \geq 0$. For $i = 0$, the image is $A_{01}/A_{01} \rightrightarrows A_{02}/A_{01} \rightrightarrows \dots \rightrightarrows A_{0n}/A_{01}$ (so the condition that the first object is 0 is fulfilled). The j -th degeneracy map consists in inserting $id_{A_{0j}}$ (which is a cofibration). So this construction is a slight variation of the nerve of $co\mathcal{C}$. However some comment is in order. If $A \rightrightarrows B$ is a cofibration, then the quotient B/A is defined as the push-out $0 \cup_A B$. The problem is that the push-out is defined only up to isomorphism and this is not at all sufficient to describe d_0 . So, the exact definition of an element in $S_n\mathcal{C}$ is not just the sequence $\{A_{0i}\}$, but all the objects A_{ij} subject to the following condition : A_{ik}/A_{ij} is isomorphic to A_{jk} .

This can be formalized by introducing the category $\text{Mor}\{0 < 1 < \dots < n\}$, see Waldhausen [1985].

One sees immediately that $\pi_1(S\mathcal{C}) = K_0(\mathcal{C})$, where the Grothendieck group of \mathcal{C} is taken with respect to the exact sequences $0 \rightarrow A \rightrightarrows C \rightarrow B \rightarrow 0$.

Examples

- 1) Let \mathcal{C} be the small category Fin_* of pointed finite sets with the inclusions as cofibrations. Then $|S\mathcal{C}|$ is homotopy equivalent to $Q(S^1) = \Omega^\infty \Sigma^\infty(S^1)$.
- 2) Let \mathcal{C} be the category $\mathcal{P}(A)$ of *f.g.* projective modules over the ring A with split monomorphisms as cofibrations. Then there is a homotopy equivalence

$$\Omega|S.P(A)| \xrightarrow{\sim} K_0(A) \times BGL(A)^+ .$$

3) Quillen (cf. [1973]) has constructed a space $|QC|$ for any category \mathcal{C} with exact sequences (this Q is for quotient and has nothing to do with $\Omega^\infty \Sigma^\infty$). If one takes for cofibrations in \mathcal{C} the monomorphisms appearing in the exact sequences, then one can show that there is a homotopy equivalence

$$|S.C| \xrightarrow{\sim} |QC| .$$

By definition the *algebraic K-theory* of the category with cofibrations \mathcal{C} is the homotopy groups of the pointed space $\Omega |S.C|$,

$$K_n(\mathcal{C}) := \pi_{n+1}(S.C), \quad n \geq 0 .$$

The main property of the S -construction is the so-called *additivity theorem*, which has a lot of important consequences for computation. Let \mathcal{C} be a category with cofibrations and \mathcal{A}, \mathcal{B} be two subcategories with cofibrations. By $\mathcal{E}(\mathcal{C}; \mathcal{A}, \mathcal{B})$ we denote the category of exact sequences, whose elements are the exact sequences

$$0 \rightarrow A \rightarrow C \rightarrow B \rightarrow 0,$$

for which A is an object of \mathcal{A} , B an object of \mathcal{B} and $B = C \cup_A 0$ (push-out in \mathcal{C}). This is obviously a category with cofibrations and it is equipped with forgetful functors

$$s : \mathcal{E}(\mathcal{C}; \mathcal{A}, \mathcal{B}) \rightarrow \mathcal{A} \text{ and } q : \mathcal{E}(\mathcal{C}; \mathcal{A}, \mathcal{B}) \rightarrow \mathcal{B} .$$

Additivity Theorem (Waldhausen [1985]) *The simplicial map*

$$S.s \times S.q : S.\mathcal{E}(\mathcal{C}; \mathcal{A}, \mathcal{B}) \rightarrow S.\mathcal{A} \times S.\mathcal{B}$$

induces a homotopy equivalence under geometric realization.

For the proof we refer to the original paper (cf. loc. cit.) or to McCarthy [1993].

Denote by $S_n\mathcal{C}$ the category whose objects are the elements of $S_n\mathcal{C}$ (the morphisms are the obvious ones). A cofibration in $S_n\mathcal{C}$ is a commutative diagram

$$\begin{array}{ccccccc} A_{00} & \rightrightarrows & A_{01} & \rightrightarrows & \cdots & \rightrightarrows & A_{0n} \\ \downarrow & & \downarrow & & & & \downarrow \\ B_{00} & \rightrightarrows & B_{01} & \rightrightarrows & \cdots & \rightrightarrows & B_{0n} \end{array}$$

where $A_{0i} \rightarrow B_{0i}$ as well as $A_{0k+1} \cup_{A_{0k}} B_{0k} \rightarrow B_{0k+1}$ are cofibrations, $i = 0, \dots, n$ and $k = 0, \dots, n - 1$. The category $S_n\mathcal{C}$ is still a category with cofibrations, so one can iterate the S -construction to obtain a (bi)simplicial category $S.S.\mathcal{C}$, and so on. Observe that, under the additivity theorem, the bisimplicial set $S.S.\mathcal{C}$ satisfies the condition of E.13.3.4, hence one gets an Ω -spectrum whose n -th component is the space $\Omega |S^{(n)}\mathcal{C}|$, $n \geq 1$, where $S^{(n)}\mathcal{C} = S \cdots S.\mathcal{C}$ (n times).

Let \mathcal{T} be the subcategory of \mathcal{C} with the same set of objects and whose morphisms are the isomorphisms. It determines a subcategory $t\mathbf{S}_n\mathcal{C}$ of $\mathbf{S}_n\mathcal{C}$, with the same objects and morphisms consisting of morphisms from \mathcal{T} . Let $N.tS.C$ be the nerve of the resulting simplicial category. One observes that $N_0t.S.C$ is just $S.C$. It follows from Lemma 1.4.1 of Waldhausen [1985], that $S.C \rightarrow N.tS.C$ is a homotopy equivalence.

13.3.8 K -theory with coefficients in a bimodule. Let R be a ring and N be a R -bimodule. According to Dundas and McCarthy the K -theory of R with coefficients in N is defined as the K -theory of the exact category, whose objects are the pairs (P, α) consisting of a projective R -module P and a R -module homomorphism from P to $P \otimes_R N$, with obvious morphisms. One denotes the corresponding space by $K(R; N)$. One observes that $K(R; 0) = K(R)$ and $K(R, R)$ is the same as the K -theory of the category of endomorphisms of finitely generated projective R -modules. In general one has

$$K(R; N) = \Omega \mid \coprod_{X \in \mathcal{S}, \mathcal{P}} Hom_{S, R-Mod}(X, X \otimes_R N) \mid .$$

Here $\mathcal{P} := \mathcal{P}(R)$ is the small category of projective f. g. left R -modules. The functor $K(R; -)$ is extended to simplicial R -bimodules by applying it degreewise.

13.3.9 Proposition. *For any R -bimodule N , there exists a natural weak homotopy equivalence*

$$K(R; K(N, 1)) \cong K(R \oplus N).$$

Proof. By cofinality property, it is known that K -theory is not changed, except in dimension 0, when projective modules are replaced by free modules. On the other hand the isomorphism classes of projective modules do not change under quotienting by a nilpotent ideal. Hence it is enough to prove the corresponding statement for free modules. Recall that $F(R)$ denotes the category of finitely generated free R -modules. The category $F(R \oplus N)$ has the following description: the objects are the same as for $F(R)$, but the morphisms from P_1 to P_2 are

$$Hom_{F(R \oplus N)}(P_1, P_2) := Hom_R(P_1, P_2) \oplus Hom_R(P_1, N \otimes_R P_2),$$

while composition is given by

$$(f, \alpha) \circ (g, \beta) = (fg, (N \otimes_R f) \circ \beta + \alpha \circ g).$$

Let \mathcal{T} be the subcategory of $F(R \oplus N)$ whose morphisms have the form $(1, \alpha)$. Since $(1, \alpha) \circ (1, \beta) = (1, \beta + \alpha)$, we see that \mathcal{T} is indeed the subcategory whose morphisms are isomorphisms. As was mentioned in 13.3.7, one has a homotopy equivalence: $S.F(R \oplus N) \rightarrow N.tS.F(R \oplus N)$. On the other hand the subcategory whose morphisms are pairs $(f, 0)$ is equivalent to the category

$F(R)$. Since the n -th component of $K(N, 1)$ is N^n , one needs to prove that the two bisimplicial sets

$$([n], [k]) \mapsto \coprod_{X \in S_n F(R)} \text{Hom}_{S_n R\text{-Mod}}(X, X \otimes_R N)^k$$

and $([n], [k]) \mapsto N_k tS_n F(R \oplus N)$ have the same homotopy type. The assignment

$$(X; \alpha_1, \dots, \alpha_k) \mapsto (Y \xleftarrow{(1, \alpha_1)} Y \xleftarrow{(1, \alpha_2)} \dots \xleftarrow{(1, \alpha_k)} Y)$$

defines a morphism Ξ_{**} from the first bisimplicial set to the second one. Here

$$X = (A_0 \xrightarrow{f_1} A_1 \xrightarrow{f_2} \dots \xrightarrow{f_n} A_n) \in S_n F(R) \text{ and}$$

$$Y = (A_0 \xrightarrow{(f_1, 0)} A_1 \xrightarrow{(f_2, 0)} \dots \xrightarrow{(f_n, 0)} A_n) \in S_n F(R \oplus N).$$

It is enough to show that Ξ_{n*} is a homotopy equivalence for each n . It is clear that Ξ_{n*} is an isomorphism into the nerve of the full subcategory of $tS_n F(R \oplus N)$ whose objects have the form

$$(A_0 \xrightarrow{(f_1, 0)} A_1 \xrightarrow{(f_2, 0)} \dots \xrightarrow{(f_n, 0)} A_n).$$

We recall that the morphisms in $tS_n F(R \oplus N)$ have the form $(1, \alpha)$. We left to the reader the task of showing that the inclusion of the subcategory into $tS_n F(R \oplus N)$ is actually an equivalence of categories to finish the proof of the proposition. □

13.3.10 Proof of Theorem 13.3.3. By Proposition 13.3.6, one has an isomorphism $K_i^s(R, N) \cong \bar{K}_{i+m}(R \oplus K(N, m - 1))$, for $i \leq m - 2$, condition that we assume all over this subsection. By the remark at the end of 13.3.4 one can take for $K_{i+m}(R \oplus K(N, m - 1))$ the degreewise construction, so one can apply Proposition 13.3.9 degreewise and get the isomorphism

$$K_{i+m}(R \oplus K(N, m - 1)) \cong K_{i+m}(R; K(N, m)).$$

By definition of the Waldhausen K -theory spectrum, one has an isomorphism

$$K_{i+m}(R; K(N, m)) \cong \pi_{i+m+k} \left| \coprod_{X \in S^{(k)} \mathcal{P}} \text{Hom}_{S^{(k)} R\text{-Mod}}(X, X \otimes_R K(N, m)) \right|$$

for any $k \geq 1$. By using exercise E.13.3.3 one then gets the isomorphism

$$(*) \quad K_i^s(R, N) \cong \pi_{i+m+k} \left| \bigoplus_{X \in S^{(k)} \mathcal{P}} \text{Hom}_{S^{(k)} R\text{-Mod}}(X, X \otimes_R K(N, m)) \right|.$$

On the other hand one has an isomorphism (see 13.2.16 and 13.1.7)

$$HML_i(R, N) \cong \pi_i(C_*(\mathcal{P}, \text{Hom}(-, - \otimes_R N))).$$

Here $C_*(\mathbf{A}, D)$ denotes the standard chain complex of the small additive category \mathbf{A} with coefficients in the bifunctor D , considered as a simplicial abelian group (see Appendix C and E.13.1.6).

Since for additive categories Waldhausen S_\bullet -construction gives a simplicial additive category, one can mix $C_*(-, Hom)$ and S_\bullet in order to get the bisimplicial abelian group $C_*(S_\bullet \mathcal{P}, Hom_{S_\bullet R-Mod}(-, - \otimes_R N))$. This is the clue of the proof.

Remark that, under the notation of exercise E.13.1.8, one has an equivalence of categories

$$S_2 \mathcal{P} \cong \begin{pmatrix} \mathcal{P} & 0 \\ Hom & \mathcal{P} \end{pmatrix}$$

because all the cofibrations in \mathcal{P} split. According to exercise E.13.1.8 one has an isomorphism

$$HML_*(S_2 \mathcal{P}, Hom(-, - \otimes_R N)) \cong HML_*(R, N) \oplus HML_*(R, N).$$

Similarly

$$HML_*(S_k \mathcal{P}, Hom(-, - \otimes_R N)) \cong HML_*(R, N)^{\oplus k}$$

and by E.13.3.4 we get

$$HML_i(R, N) \cong \pi_{i+1} C_*(S \mathcal{P}, Hom_{S \cdot R-Mod}(-, - \otimes_R N)).$$

By iteration we obtain:

$$HML_i(R, N) \cong \pi_{i+k} C_*(S^{(k)} \mathcal{P}, Hom_{S^{(k)} R-Mod}(-, - \otimes_R N)).$$

It follows from the additivity of the functor $C_*(\mathcal{X}, -)$ that

$$HML_i(R, N) \cong \pi_{i+k+m} C_*(S^{(k)} \mathcal{P}, Hom_{S^{(k)} R-Mod}(-, - \otimes_R K(N, m))).$$

We remark that

$$\bigoplus_{X \in S^{(k)} \mathcal{P}} Hom_{S^{(k)} R-Mod}(X, X \otimes_R (?))$$

in (*) is the 0-th component in the C -direction of

$$C_*(S^{(k)} \mathcal{P}, Hom_{S^{(k)} R-Mod}(-, - \otimes_R (?))).$$

Hence the theorem follows from the following proposition.

13.3.11 Proposition. *The inclusion of the 0-th component into the full simplicial object yields an isomorphism*

$$\pi_{k+i} C_0(S^{(k)} \mathcal{P}, Hom_{S^{(k)} R-Mod}(-, - \otimes_R N)) \cong \pi_{k+i} C_*(S^{(k)} \mathcal{P}, Hom_{S^{(k)} R-Mod}(-, - \otimes_R N))$$

provided $i < k - 1$.

Proof. For simplicity we set

$$C_n(S^{(k)}) := C_n(S^{(k)}\mathcal{P}, Hom_{S^{(k)}R-Mod}(-, - \otimes_R N)).$$

We will show that the iteration δ of degeneracy operators from the zeroth component to the n -th component $\delta : C_0(S^{(k)}) \rightarrow C_n(S^{(k)})$ yields an isomorphism on π_{k+i} for $i < k - 1$. This implies the result by applying the spectral sequence of a bicomplex. Denote by $d : C_n(S^{(k)}) \rightarrow C_0(S^{(k)})$ the iteration of the zeroth face map. We observe that $d \circ \delta = id$, so it is enough to show that $c = \delta \circ d : C_n(S^{(k)}) \rightarrow C_n(S^{(k)})$ yields the identity map on π_{i+k} for $i < k - 1$. Denote a homogenous element of

$$\bigoplus_{a_0 \leftarrow \dots \leftarrow a_n} Hom(a_0, a_{-1})$$

corresponding to the summand $a_0 \leftarrow \dots \leftarrow a_n$ and the element $a_0 \rightarrow a_{-1}$ by $a = (a_{-1} \xleftarrow{\alpha_0} \dots \xleftarrow{\alpha_n} a_n)$. Observe that $c(a) = (a_{-1} \xleftarrow{\beta_0} a_n = \dots = a_n)$, where $\beta_0 = \alpha_0 \alpha_1 \dots \alpha_n$. We recall that S_2 can be identified with the set of admissible short exact sequences, and that the face homomorphisms $d_i, i = 0, 1, 2$, in the S -construction are given by

$$d_i(0 \rightarrow a_2 \rightarrow a_1 \rightarrow a_0 \rightarrow 0) = a_i.$$

According to Dundas and McCarthy [1994] [1996], one defines homomorphisms $t_{id}, t_\beta : C_n \rightarrow C_n S_2$, by

$$\begin{aligned} t_{id}(a) &= (x_{-1} \xleftarrow{\xi_0} \dots \xleftarrow{\xi_n} x_n) \\ t_\beta(a) &= (y_{-1} \xleftarrow{\eta_0} \dots \xleftarrow{\eta_n} y_n) \end{aligned}$$

where

$$\begin{aligned} x_i &= (0 \rightarrow a_n \xrightarrow{(1,0)} a_n \oplus a_i \xrightarrow{\binom{0}{1}} a_i \rightarrow 0), \quad i \geq 0, \\ x_{-1} &= (0 \rightarrow a_{-1} \xrightarrow{(1,0)} a_{-1} \oplus a_{-1} \xrightarrow{\binom{0}{1}} a_{-1} \rightarrow 0), \\ y_i &= (0 \rightarrow a_n \xrightarrow{(1,\beta_i)} a_n \oplus a_i \xrightarrow{\binom{\beta_i}{-1}} a_i \rightarrow 0), \quad i \geq 0, \\ y_{-1} &= (0 \rightarrow a_{-1} \xrightarrow{(1,1)} a_{-1} \oplus a_{-1} \xrightarrow{\binom{1}{-1}} a_{-1} \rightarrow 0), \\ \beta_i &= \alpha_i \dots \alpha_n, \\ \eta_i &= \xi_i = (1, \begin{pmatrix} 1 & 0 \\ 0 & \alpha_i \end{pmatrix}, \alpha_i), \quad i \geq 1, \\ \xi_0 &= (0, \begin{pmatrix} 0 & \alpha_0 \\ 0 & \alpha_0 \end{pmatrix}, \alpha_0), \\ \eta_0 &= (\beta_0, \begin{pmatrix} 0 & \alpha_0 \\ 0 & \alpha_0 \end{pmatrix}, 0). \end{aligned}$$

One checks that $d_0t_{id} = id$, $d_2t_\beta = c$, $d_2t_{id} = 0 = d_0t_\beta$, $d_1t_{id} = d_1t_\beta$. Observe that C_n and C_nS_2 are the 1-components of C_nS and $C_nS.S_2$ respectively and that t_{id}, t_β have obvious extensions $T_{id}, T_\beta : C_n(S^{(k)}) \rightarrow C_n(S^{(k)})S_2$, simply by applying t_{id} and t_β to each level of filtration. By Lemma 13.3.12 below one has

$$\begin{aligned} \pi_{k+i}(id) &= \pi_{k+i}(d_0Tid) \\ &= \pi_{k+i}(d_1Tid) \\ &= \pi_{k+i}(d_1T\beta) \\ &= \pi_{k+i}(d_2T\beta) \\ &= \pi_{k+i}(c) \end{aligned}$$

assuming $i < k - 1$, and the proof is complete.

13.3.12 Lemma. *The two maps*

$$(d_1)_* : C_n(S^{(k)})S_2 \rightarrow C_n(S^{(k)})$$

and

$$(d_0)_* + (d_2)_* : C_n(S^{(k)})S_2 \rightarrow C_n(S^{(k)})$$

agree on π_{k+i} if $i < k - 1$.

Proof. The proof of the additivity theorem, that is $S.S_2 \rightarrow S \times S$ is a homotopy equivalence, as given in McCarthy [1993], uses only constructions and homotopies by exact functors. Thus

$$C_n(S.S_2) \rightarrow C_n(S \times S)$$

is also homotopy equivalence. On the other hand

$$C_n(S^{(k)} \times S^{(k)}) \rightarrow C_n(S^{(k)}) \times C_n(S^{(k)})$$

yields an isomorphism on π_{k+i} for $i < k - 1$, because as a multisimplicial group, they agree in total degree less than $2k$. Therefore

$$((d_0)_*, (d_2)_*) : C_n(S^{(k)})S_2 \rightarrow C_n(S^{(k)}) \times C_n(S^{(k)})$$

yields an isomorphism on π_{k+i} for $i < k - 1$. This map has a section $\phi(a, b) := (s_0)_* + (s_1)_*$, where $s_i, i = 0, 1 : S_1 \rightarrow S_2$ are the degeneracy operators in S_* . One checks that $(d_1)_*\phi$ is the addition and the proof of the lemma is complete. \square

Exercises

E.13.3.1 According to Quillen [1972] :

$$H_i(GL(\mathbf{Z}/p\mathbf{Z}), \mathbf{Z}/p\mathbf{Z}) = 0, \text{ for } i > 0.$$

Use this fact as well as Theorem 13.4.2 of the next section to show that

$$\begin{aligned} H_{2i}(GL(\mathbf{Z}/p\mathbf{Z}), \mathcal{M}(\mathbf{Z}/p\mathbf{Z})) &= \mathbf{Z}/p\mathbf{Z}, \\ H_{2i+1}(GL(\mathbf{Z}/p\mathbf{Z}), \mathcal{M}(\mathbf{Z}/p\mathbf{Z})) &= 0. \end{aligned}$$

E.13.3.2 Let R_* be a simplicial ring and I_* be the kernel of $R_* \rightarrow \pi_0 R_*$. Show that, if R_* is complete in the I_* -adic topology, then $\widehat{GL}(R_*)$ is isomorphic to the simplicial group $GL(R_*)$ given by $[k] \mapsto GL(R_k)$, and $\widehat{BGL}(R_*)^+$ is homotopy equivalent to the degreewise $+$ -construction:

$$| [k] \mapsto BGL(R_k)^+ |.$$

One calls such simplicial rings *complete*. Show that if $\pi_0 R_*$ is torsion free, then there exists a complete simplicial ring S_* and a weak homotopy equivalence $S_* \rightarrow R_*$ (see Song [1992]).

E.13.3.3 Let B be a simplicial set. We say that $p : E_* \rightarrow B_*$ is an abelian group over B if p is a map of simplicial sets such that, for each $b \in B_n$, the set $p^{-1}(b)$ has an abelian group structure. Moreover for any nondecreasing map $f : [m] \rightarrow [n]$, the induced map $f_* : p^{-1}(b) \rightarrow p^{-1}(f_*(b))$ is assumed to be a homomorphism. Let $tr(p : E_* \rightarrow B_*)$ be the simplicial abelian group given by $\bigoplus_{b \in B_*} p^{-1}(b)$. Suppose $p^{-1}(b)$ is c -connected for any $b \in B_n$ and $p^{-1}(b) = 0$ if $n < q$, where c and q are the integers. Then the natural map

$$E_*/B_* = \bigvee_{b \in B_*} p^{-1}(b) \rightarrow tr(p) = \bigoplus_{b \in B_*} p^{-1}(b)$$

is $(2c + q + 1)$ -connected (J. Lannes. Talk in a seminar at IHES).

E.13.3.4 Let X_{**} be a bisimplicial set such that X_{0*} is contractible. Let $i_k : [1] \rightarrow [n]$ be given by $i_k(j) = j + k - 1$. Assume that the map $p_n = (i_1^*, \dots, i_n^*) : X_{n*} \rightarrow X_{1*}^n$ is a weak homotopy equivalence. Show that $|X_{1*}| \rightarrow \Omega |X_{**}|$ is a weak homotopy equivalence if and only if the monoid $\pi_0 X_{1*}$ is a group, where the monoid structure on $\pi_0 X_{1*}$ is induced by $(\pi_0 d_{1*}) \circ (\pi_0 p_2)^{-1}$. (cf. Segal [1974]).

13.4 Calculations

In this section we compute Mac Lane (co)homology for the rings \mathbf{Z} and $\mathbf{Z}/p\mathbf{Z}$. First, we give a brief review of a computation based on the Steenrod algebra (i.e. using the cubical definition of Mac Lane). This computation is fairly simple for $p = 2$, but more complicated for p odd. Second, we give a purely algebraic computation for $\mathbf{Z}/p\mathbf{Z}$ based on the vanishing lemma 13.4.5 (i.e.

using the *Ext* definition). Third, we use this result to achieve the computation for \mathbf{Z} .

13.4.1 Brief review of a topological approach to $HML_*(\mathbf{Z}/p\mathbf{Z})$. Let p be a prime number. Let $\mathcal{A}_*(p)$ be the dual of the Steenrod algebra. By Theorem 13.2.2 one has an additive isomorphism:

$$H_*(Q_*(\mathbf{Z}/p\mathbf{Z}) \otimes \mathbf{Z}/p\mathbf{Z}) \cong \mathcal{A}_*(p).$$

Moreover, one can prove that this is an isomorphism of associative algebras. By a theorem of Milnor one knows that

$$\mathcal{A}_*(2) \cong \mathbf{Z}/2\mathbf{Z}[\xi_1, \dots, \xi_i, \dots],$$

where $\deg \xi_i = 2^i - 1$ and for odd p one has

$$\mathcal{A}_*(p) \cong \mathbf{Z}/p\mathbf{Z}[\xi_1, \dots, \xi_i, \dots] \otimes \Lambda^*(\tau_0, \tau_1, \dots),$$

where $\deg \xi_i = 2(p^i - 1), i \geq 1$ and $\deg \tau_j = 2p^j - 1, j \geq 0$. Here Λ^* denotes the exterior algebra. Since $\mathbf{Z}/p\mathbf{Z} \otimes \mathbf{Z}/p\mathbf{Z} = \mathbf{Z}/p\mathbf{Z}$, one has

$$HML_*(\mathbf{Z}/p\mathbf{Z}) = H_*(Q_*(\mathbf{Z}/p\mathbf{Z}) \otimes \mathbf{Z}/p\mathbf{Z}, \mathbf{Z}/p\mathbf{Z}).$$

Since, by definition, the Hochschild homology of a DG ring is the homology of a bicomplex, there are two associated spectral sequences. If we calculate homology first in the vertical direction, that is for the cubical construction, and second in the horizontal direction, then we get a spectral sequence:

$$E_{**}^2 = H_*(\mathcal{A}_*(p), \mathbf{Z}/p\mathbf{Z}) \implies HML_*(\mathbf{Z}/p\mathbf{Z}).$$

The case $p = 2$ is easy to handle. By Section 2 of Chapter 3 the Hochschild homology of a polynomial algebra is known, thus

$$E_{**}^2 = \Lambda^*(\sigma_1, \sigma_2, \dots),$$

where σ_i has bidegree $(1, 2^i - 1)$. Since σ_i has total degree 2^i , we see that all nontrivial terms in the spectral sequence have even total degree, so all the differentials vanish, by a degree argument. Moreover, again by a degree argument, one sees that the total E^2 -module is trivial in odd degrees and is one-dimensional in each even degree. Hence

$$HML_{2i}(\mathbf{Z}/2\mathbf{Z}) = \mathbf{Z}/2\mathbf{Z}$$

and

$$HML_{2i+1}(\mathbf{Z}/2\mathbf{Z}) = 0.$$

The situation changes dramatically, when p is odd. Calculation of E^2 (see for example Proposition 2.1 of McClure and Staffeldt [1993]) gives:

$$E_{**}^2 = \Lambda^*(\sigma_1, \sigma_2, \dots) \otimes \Gamma^*(\eta_0, \eta_1, \dots),$$

where Γ^* denotes the divided power algebra. The bidegree of σ_i (resp. η_i) is $(1, 2p^i - 1)$ (resp. $(1, 2p^i)$). However there is no reason for the differentials to be zero. Indeed, as was proved independently by Breen [1978] and Bökstedt [1985b], there is one nontrivial differential (and only one), namely d^{p-1} (actually Bökstedt used a similar, but different, spectral sequence). The final answer looks similar.

13.4.2 Theorem (Breen [1978], Bökstedt [1985]). *For any prime p one has isomorphisms*

$$HML^{2i}(\mathbf{Z}/p\mathbf{Z}) \cong \mathbf{Z}/p\mathbf{Z}$$

and

$$HML^{2i+1}(\mathbf{Z}/p\mathbf{Z}) = 0, \quad i \geq 0.$$

The proof involves the Dyer-Lashof operations and is quite complicated. Moreover Bökstedt was able to prove the following

13.4.3 Theorem (Bökstedt [1985]). *One has isomorphisms*

$$HML^{2i}(\mathbf{Z}) \cong \mathbf{Z}/i\mathbf{Z},$$

$$HML^{2i-1}(\mathbf{Z}) = 0, \quad i \geq 1.$$

By the universal coefficients formula one gets the computation in homology

$$HML_{2i}(\mathbf{Z}/p\mathbf{Z}) \cong \mathbf{Z}/p\mathbf{Z} \quad \text{and} \quad HML_{2i+1}(\mathbf{Z}/p\mathbf{Z}) = 0, \quad i \geq 0,$$

$$HML_{2i-1}(\mathbf{Z}) \cong \mathbf{Z}/i\mathbf{Z} \quad \text{and} \quad HML_{2i}(\mathbf{Z}) = 0, \quad i \geq 1.$$

In 13.4.14 and 13.4.20 we give a purely algebraic proof of the calculation of $HML^*(\mathbf{Z}/p\mathbf{Z}, \mathbf{Z}/p\mathbf{Z})$ and $HML^*(\mathbf{Z}, \mathbf{Z})$.

13.4.4 Algebraic approach to $HML_*(\mathbf{Z}/p\mathbf{Z})$ (V. Franjou, J. Lannes and L. Schwartz [1994]). We start with the following simple but important observation, which goes back to Dold and Puppe [1961] (see Korollar 5.20 of *loc. cit.*). A functor F from an additive category \mathcal{A} to another additive category \mathcal{B} is called *diagonalizable* if it is a composite of the form $F = T \circ \Delta$, where $\Delta : \mathcal{A} \rightarrow \mathcal{A} \times \mathcal{A}$ is the diagonal map and $T : \mathcal{A} \times \mathcal{A} \rightarrow \mathcal{B}$ is a bifunctor satisfying $T(0, X) = 0 = T(X, 0)$ for every object X in \mathcal{A} .

13.4.5 Lemma (Pirashvili [1988]). *If F is a diagonalizable functor in $\mathcal{F}(R)$ and J is an additive functor, then*

$$Ext_{\mathcal{F}(R)}^*(J, F) = 0 = Ext_{\mathcal{F}(R)}^*(F, J).$$

In particular if F' and F'' are two functors which map 0 to 0, and if R is commutative, then

$$Ext_{\mathcal{F}(R)}^*(J, F' \otimes F'') = 0 = Ext_{\mathcal{F}(R)}^*(F' \otimes F'', J).$$

Proof. The category of bifunctors T satisfying $T(0, X) = 0 = T(X, 0)$ is an abelian category with sufficiently many projective and injective objects. Moreover $T \mapsto T \circ \Delta$ is an exact functor which preserves projective and injective objects. Hence it is enough to check the assertion in dimension zero, which is easy to do. \square

The following is an application of Lemma 13.4.5, where S^n (resp. Λ^n) denotes the n -th symmetric (resp. exterior) power functor.

13.4.6 Proposition. *Assume A is a commutative ring and $n \geq 2$.*

- i) If n is not a prime power, then $HML^*(A, S^n) = 0$.*
- ii) If $n = p^h$ is a power of a prime p , then $HML^*(A, S^n)$ is annihilated by p .*
- iii) One has an isomorphism*

$$HML^i(A, \Lambda^n) \cong HML^{i-n+1}(A, S^n).$$

Proof. i)-ii) (compare with the proof of Satz 10.9 of Dold-Puppe [1961]). By Lemma 13.4.5 we know that $HML^*(A, Sym^i \otimes Sym^j) = 0$, for $i, j > 1$. The composition $S^n \rightarrow S^i \otimes S^{n-i} \rightarrow S^n$ is the multiplication by the binomial coefficient $\binom{n}{i}$. Here the first (resp. second) map comes from the comultiplication (resp. multiplication) in the symmetric algebra. Thus $HML^*(A, S^n)$ is annihilated by $\binom{n}{i}$, for $1 \leq i \leq n - 1$. Now it is enough to remark that the greatest common divisor of the numbers $\binom{n}{1}, \binom{n}{2}, \dots, \binom{n}{n-1}$ is p , if n is power of p , and is 1, if n not a prime power (see *loc. cit.*).

iii) Take $R = S^*(W)$, $V = S^*(W) \otimes W$ and define $x : V \rightarrow R$ to be multiplication in the symmetric algebra. By Lemma 3.4.8 we know that the Koszul complex $\mathcal{K}(x)$ is acyclic. Moreover the formula for d_x in 3.4.6 shows that the Koszul complex splits as the direct sum of its homogeneous components. Hence for any $n \geq 0$ one gets the following exact sequence:

$$0 \rightarrow \Lambda^n(W) \rightarrow \Lambda^{n-1}(W) \otimes W \rightarrow \dots \rightarrow W \otimes S^{n-1}(W) \rightarrow S^n(W) \rightarrow 0.$$

Varying W we get an exact sequence in $\mathcal{F}(A)$:

$$0 \rightarrow \Lambda^n \xrightarrow{\kappa} \Lambda^{n-1} \otimes I \xrightarrow{\kappa} \dots \xrightarrow{\kappa} I \otimes S^{n-1} \xrightarrow{\kappa} S^n \rightarrow 0$$

and the result follows from Lemma 13.4.5. \square

Notation. For simplicity we denote $\mathcal{F}(\mathbf{Z}/p\mathbf{Z})$ by \mathcal{F} and $HML^*(\mathbf{Z}/p\mathbf{Z}, T)$ by $HML^*(T)$. We recall the following

13.4.7 Lemma (Kuhn [1995]). *Assume $T \in \mathcal{F}$ has a projective resolution of finite type. Then, for any $k > 0$, one has*

$$\text{colim } Ext_{\mathcal{F}}^k(T, S^{p^n}) = 0,$$

where S^n denotes the n -th symmetric power and the limit is considered with respect to the Frobenius maps $\Phi : S^{p^n} \rightarrow S^{p^{n+1}}$.

We use this fact, for $T = I$. By Lemma 13.2.12 and Lemma 13.2.13 we know that I has a projective resolution of finite type. There is an elementary (though quite long) proof of this lemma in Kuhn [1995], and also in the appendix of Franjou, Lannes and Schwartz [1994]). In 13.4.19 we give a more conceptual proof, along the lines of the second appendix of Franjou, Lannes and Schwartz [1994], which, however, uses deeper facts.

First recall some auxiliary results.

13.4.8 Cartier homomorphism and de Rham cohomology in characteristic p . Let A be a commutative $\mathbf{Z}/p\mathbf{Z}$ -algebra. It is easy to check that the coboundary map in the de Rham complex Ω_A^* is A -linear, when the A -module structure on Ω_A^* is given via Frobenius:

$$a \star \omega = a^p \omega.$$

Thus $H_{DR}^*(A)$ has the natural A -module structure, given by the same formula. Let $C : A \rightarrow H_{DR}^*(A)$ be the map given by $C(a) = a^{p-1} da$. Since $C(ab) = a \star C(b) + b \star C(a)$, it can be uniquely extended to a homomorphism of A -algebras:

$$C : \Omega_A^* \rightarrow H_{DR}^*(A).$$

This homomorphism was introduced by Cartier [1957]. It turns out that it is an isomorphism for symmetric algebras. Indeed, the result is quite easy when $\dim W = 1$ and the general case follows from the fact that C is compatible with the identifications $\Omega_{S^*(W \oplus V)} \cong S^*(W) \otimes S^*(V)$ and $H_{DR}^*(W \oplus V) \cong H_{DR}^*(W) \otimes H_{DR}^*(V)$. Observe that one has a natural (in V) isomorphism: $\Omega_{S^*(V)}^n \cong S^*(V) \otimes \Lambda^n$ and the de Rham differential sends $S^k(V) \otimes \Lambda^n$ to $S^{k-1}(V) \otimes \Lambda^{n+1}$. Thus we get a cochain complex:

$$S^n \xrightarrow{d} S^{n-1} \otimes I \xrightarrow{d} \dots \xrightarrow{d} I \otimes \Lambda^{n-1} \xrightarrow{d} \Lambda^n \rightarrow 0 \rightarrow 0 \rightarrow \dots$$

which is denoted by Ω_n^* .

13.4.9 Proposition. *The Frobenius transformation $\Phi : S^{p^h} \rightarrow S^{p^{h+1}}$ yields an isomorphism*

$$\Phi_* : HML^i(S^{p^{h-1}}) \cong HML^i(S^{p^h}) \quad \text{if } 0 \leq i \leq 2p^{h-1} - 2.$$

Proof. Consider the hypercohomology spectral sequences corresponding to the bicomplex $\Omega_{p^h}^*$. Since

$$H^*(\Omega_{p^h}^*) \cong \Omega_{p^{h-1}}^*$$

(thanks to Cartier result), they have the following form:

$$\Omega_1^{st} = \begin{cases} HML^t(S^{p^h}) & \text{if } s = 0, \\ HML^{t-p^h+1}(S^{p^h}) & \text{if } s = p^h, \\ 0 & \text{otherwise,} \end{cases}$$

$$\Omega \mathbf{II}_2^{st} = \begin{cases} HML^s(S^{p^{h-1}}) & \text{if } t = 0, \\ HML^{s-p^{h-1}+1}(S^{p^{h-1}}) & \text{if } t = p^{h-1}, \\ 0 & \text{otherwise.} \end{cases}$$

Both spectral sequences have the same abutment $HML^*(\Omega_{p^h}^*)$. The first spectral sequence gives the isomorphism: $HML^i(S^{p^h}) \cong HML^*(\Omega_{p^h}^*)$ for $i \leq 2p^h - 2$, while the second one gives $HML^i(S^{p^{h-1}}) \cong HML^*(\Omega_{p^h}^*)$ for $i \leq 2p^{h-1} - 2$ and we get the result. \square

13.4.10 Corollary. *The group $HML^0(S^{p^h})$ is one dimensional and the iterated Frobenius homomorphism is a generator. Moreover if $1 \leq i \leq 2p^h - 2$, then $H^i(S^{p^h}) = 0$.*

Proof. It is a direct consequence of Lemma 13.4.7 and of Proposition 13.4.9. \square

In order to continue, we need to consider the hypercohomology spectral sequence for some auxiliary complex K_n^* . The morphism of complexes $K_n^* \rightarrow \Omega_n^*$ gives rise to a morphism of the corresponding spectral sequences. This will be of great help in understanding the differentials and the whole picture of the above spectral sequences.

13.4.11 Euler Formula for Differential Forms. We recall that κ denotes the boundary in the Koszul complex, while d is the de Rham boundary map. Both of them acts on the same graded vector space Ω_n^* , where κ has degree -1 , and d has degree $+1$. The Euler formula asserts that

$$d\kappa + \kappa d : \Omega_n^* \rightarrow \Omega_n^*$$

coincides with multiplication by n . Indeed the additive map $gr_\Omega : \oplus \Omega_n \rightarrow \oplus \Omega_n$ given by $gr_\Omega(\omega_n) = n\omega_n$, $\omega_n \in \Omega_n$ is a derivation. The same is true for $d\kappa + \kappa d$. Since both of them coincide in degree one, they are equal to each other.

Consider now the case where $p \mid n$. By the Euler formula κ yields a well defined homomorphism in $H^*(\Omega_n)$. Since the Cartier homomorphism is multiplicative, we see that κ is compatible with it.

13.4.12 The Functors K_n^i . We set

$$K_n^i = Ker(\kappa : S^{n-i} \otimes \Lambda^i \rightarrow S^{n-i+1} \otimes \Lambda^{i-1}).$$

By the exactness of the Koszul complex there is an exact sequence

$$0 \rightarrow K_n^i \rightarrow S^{n-i} \otimes \Lambda^i \rightarrow K_n^{i-1} \rightarrow 0.$$

By Lemma 13.4.5 one gets $HML^m(K_n^i) \cong HML^{m-i}(S^n)$.

13.4.13 The Complex K_{pn} . The Euler formula shows that the de Rham differential sends K_n^i to K_n^{i+1} provided that $p \mid n$. Hence K_{pn} is a subcomplex of Ω_{pn} . We claim that the Cartier homomorphism yields the following isomorphism:

$$K_n^* \cong H^*(K_{pn}^*, d).$$

Indeed, consider the Koszul complex as a module over the dual numbers $D = (\mathbf{Z}/p\mathbf{Z})[\epsilon]$, where $\epsilon^2 = 0$ and where the action of ϵ corresponds to κ . Then $\text{Hom}_D(\mathbf{Z}/p\mathbf{Z}, -)$ (with trivial action of ϵ on $\mathbf{Z}/p\mathbf{Z}$) represents the kernel of the action of ϵ . In the category of D -modules, acyclic complexes are free and injective objects. Hence

$$H^*(K_{pn}^*, d) \cong H^*(\text{Hom}_D(\mathbf{Z}/p\mathbf{Z}, \Omega_{pn}^*)) = \text{Hom}_D(\mathbf{Z}/p\mathbf{Z}, H^*(\Omega_{pn}^*)).$$

13.4.14 More notation. Let Λ denote the following graded algebra:

$$\Lambda := \mathbf{Z}/p\mathbf{Z}[e_0, \dots, e_h, \dots] / (e_h^p; h \geq 0),$$

where e_h is a class of degree $2p^h$. Let Λ_k be the quotient of Λ by the ideal generated by e_0, \dots, e_{k-1} .

Now we are ready to formulate the following

13.4.15 Theorem (Franjou, Lannes and Schwartz [1994]). *There exist isomorphisms of graded associative algebras:*

$$\text{HML}^*(\mathbf{Z}/p\mathbf{Z}, \mathbf{Z}/p\mathbf{Z}) \cong \Lambda,$$

where the ring structure on $\text{HML}^*(\mathbf{Z}/p\mathbf{Z}, \mathbf{Z}/p\mathbf{Z}) = \text{Ext}_{\mathcal{F}}^*(I, I)$ is given by the Yoneda product. Moreover for any integer $h \geq 0$, there exists an isomorphism of right Λ -modules

$$\text{HML}^*(\mathbf{Z}/p\mathbf{Z}, S^{p^h}) \cong \Lambda_h,$$

where the right Λ -module structure on $\text{HML}^*(\mathbf{Z}/p\mathbf{Z}, S^n) \cong \text{Ext}_{\mathcal{F}}^*(I, S^n)$ is still given by the Yoneda product.

Proof. Consider the hypercohomology spectral sequences corresponding to the bicomplex K_{pn} . By 13.4.12 and 13.4.13 they have the following form:

$${}_K \mathbf{I}_1^{st} = \begin{cases} \text{HML}^{t-s}(S^{p^h}) & \text{if } 0 \leq s \leq p^h - 1, \\ 0 & \text{otherwise,} \end{cases}$$

$${}_K \mathbf{II}_2^{st} = \begin{cases} \text{HML}^{s-t}(S^{p^{h-1}}) & \text{if } 0 \leq t \leq p^h - 1, \\ 0 & \text{otherwise.} \end{cases}$$

Both of them have the same abutment $H^*(K_{pn})$. The inclusion of cochain complexes $K_{p^h}^* \hookrightarrow \omega_{p^h}^*$ yields the morphism of spectral sequences

$$\gamma : {}_K \mathbf{II}_r^{st} \rightarrow {}_\Omega \mathbf{II}_r^{st}$$

Observe that γ is the identity on the line $t = 0$ and γ is zero on the terms $t > 0$, by a degree argument. Hence all differentials of the spectral sequence ${}_K\mathbf{II}_r^{st}$ which land on the line $t = 0$ are zero and hence ${}_K\mathbf{II}_2^{s0} = H^*(S^{p^{h-1}}) \rightarrow H^*(K_{pn})$ is a monomorphism. After this observation, the proof will be performed in several steps.

13.4.16 First Step. For odd k one has $HML^k(S^{p^h}) = 0$. Indeed, fix a natural number N and consider the following properties

$$(\mathcal{P}_N(h)) \quad HML^k(S^{p^h}) = 0 \text{ for odd } k \leq N,$$

$$(\mathcal{Q}_N(h)) \quad HML^k(K_{p^h}^*) = 0 \text{ for odd } k \leq N.$$

Observe that for a fixed integer N the property $(\mathcal{P}_N(h))$ holds for $h \gg 0$ (thanks to 13.4.10) and

$$(\mathcal{P}_N(h)) \implies (\mathcal{Q}_N(h))$$

(thanks to the spectral sequence ${}_K\mathbf{I}$). On the other hand, the observation made in 13.4.14 shows that

$$(\mathcal{Q}_N(h)) \implies (\mathcal{P}_N(h - 1)).$$

Thus $(\mathcal{P}_N(h))$ is true for any $h \geq 0$. Since N was arbitrary, the claim is proved.

13.4.17 Second Step. The theorem is true additively, that is $HML^i(S^{p^h})$ is $\mathbf{Z}/p\mathbf{Z}$ if $2p^h \mid i$ and 0 otherwise. Indeed, it follows from the claim in Lemma 13.4.16, that all terms in the spectral sequences ${}_K\mathbf{I}$ and ${}_K\mathbf{II}$ are zero if the total degree is odd. Thus they are degenerate at ${}_K\mathbf{I}_1$ and ${}_K\mathbf{II}_2$. We denote by $P_h(X)$ the Poincaré series (with coefficients in $\mathbf{N} \cup \infty$) for $HML^*(S^{p^h})$:

$$\sum_{k=0}^{\infty} \dim H^k(S^{p^h}) X^k.$$

Since ${}_K\mathbf{I}$ and ${}_K\mathbf{II}$ have the same abutment, one can compare their Poincaré series and we get:

$$\sum_{\alpha=0}^{p^h-1} X^{2\alpha} P_h(X) = \sum_{\alpha=0}^{p^{h-1}-1} X^{2\alpha} P_{h-1}(X).$$

Therefore, for any h one has:

$$(13.4.17.1) \quad P_0(X) = \sum_{\alpha=0}^{p^h-1} X^{2\alpha} P_h(X).$$

It follows from Corollary 13.4.10, that the $< N$ degree part of $P_h(X)$ is 1 if $N \gg 0$. This fact, together with equation (13.4.17.1), shows that $P_0(X) = \sum_{\alpha \geq 0} X^{2\alpha}$. Applying (13.4.17.1) again finishes the proof of the second step.

13.4.18 Third Step. *End of the proof.* We return to the spectral sequences ${}_{\Omega}\mathbf{I}$ and ${}_{\Omega}\mathbf{II}$. Since the additive structure of $HML^*(S^{p^h})$ is known, we can compute the differentials. First observe that, by a degree argument, there are no nontrivial differentials on ${}_{\Omega}\mathbf{I}$ and it degenerates at ${}_{\Omega}\mathbf{I}_1$. Hence $HML^i(\Omega_{p^h}^*) = \mathbf{Z}/p\mathbf{Z}$ for $i = 0, 2p^h - 1, 2p^h, \dots, 4p^h - 1, 4p^h, \dots$ and is zero otherwise. Now we know the abutment of ${}_{\Omega}\mathbf{II}$. Clearly, the nontrivial differentials are

$$d_{p^h} : HML^{k-2p^{h-1}}(S^{p^{h-1}}) \rightarrow HML^k(S^{p^{h-1}}).$$

By comparing the nontrivial terms we can conclude that $d_{p^h} = 0$ when $2p^h \mid k$ and an isomorphism otherwise. Thus

$$\Phi_k : HML^k(S^{p^{h-1}}) \rightarrow HML^k(S^{p^h})$$

is an isomorphism, when $2p^h \mid k$. Therefore, when $2p^h \nmid k$, the iteration

$$\Phi_k^{h-1} : HML^k(I) \rightarrow HML^k(S^{p^h})$$

is an isomorphism too. Now we define

$$e_h := (\Phi_{2p^h}^h)^{-1}(d_{p^{h+1}}(\Phi^h)) \in HML^{2p^h}(\mathbf{Z}/p\mathbf{Z}, \mathbf{Z}/p\mathbf{Z}).$$

From the above information on differentials, it follows that e_k is nontrivial and $e_k^p = 0$. By the well-known properties of Hochschild cohomology (see Gerstenhaber [1963]), one knows that $H^*(R, R)$ is a commutative algebra. Since Mac Lane cohomology is Hochschild cohomology of $Q_*(R)$ (cf. 13.2.8), one sees that $HML^*(\mathbf{Z}/p\mathbf{Z}, \mathbf{Z}/p\mathbf{Z})$ is a commutative algebra. Hence we have a well-defined algebra morphism $\Lambda \rightarrow HML^*(\mathbf{Z}/p\mathbf{Z}, \mathbf{Z}/p\mathbf{Z})$, which is an isomorphism, by counting the dimensions of both sides. The same is true for $HML^*(\mathbf{Z}/p\mathbf{Z}, S^{p^h})$. □

13.4.19 Unstable modules over the Steenrod algebra and the category \mathcal{F} . Comparing the topological and algebraic approaches leads one to look for the existence of a link between the representations of the Steenrod algebra and our category \mathcal{F} . Indeed, such a link is given by a remarkable result due to Henn, Lannes and Schwartz [1993] (see also Kuhn [1994a] for an algebraic explanation). For simplicity we consider the case $p = 2$, but what follows is also true for p odd, with slight modifications (see Kuhn [1994a]). We let A denote, as earlier, $A(2)$, that is the Steenrod algebra. Recall that a graded A -module M is called *unstable* if the following holds

- if $x \in M^i$ and $j > i$, then $Sq^j x = 0$.

Remark that for any space X , the mod-2 cohomology $H^*(X)$ is an example of an unstable A -module. Let \mathcal{U} be the category of unstable A -modules.

An unstable A -module M is called *nilpotent* if, for any $x \in M$, there exists $k > 0$ such that $(S_{q_0})^k x = 0$. Here $S_{q_0} : M^n \rightarrow M^{2n}$ is given by $m \mapsto Sq^{2n}m$ and $(S_{q_0})^k$ denotes the k -th iteration of S_{q_0} . Let \mathcal{N} be the category of nilpotent unstable modules. Obviously it is a Serre subcategory in \mathcal{U} . The result of Henn, Lannes and Schwartz [1993] claims that the category \mathcal{U}/\mathcal{N} is equivalent to the category of *analytical functors*, that is, the full subcategory of \mathcal{F} whose objects can be represented as unions of finite degree functors (see E.13.1.3). Without using the notion of factor-categories, this means the following:

- there exists an exact functor $f : \mathcal{U} \rightarrow \mathcal{F}$, with right adjoint functor $m : \mathcal{F} \rightarrow \mathcal{U}$,
- $f(M) = 0$ if and only if $M \in \mathcal{N}$,
- if $F \in \mathcal{F}$ is analytical, then $f \circ m(F) \rightarrow F$ is an isomorphism.

Moreover, the following holds

- if the values of F are finite dimensional, then

$$m(F)^n = Hom_{\mathcal{F}}(DF, S^n),$$

where $DF : X \mapsto (F(X^*))^*$ is the dual of F . Here $(-)^*$ denotes the linear dual of a vector space.

- By the previous property, the Frobenius transformation $S^n \rightarrow S^{2n}$ yields a map $m(F)^n \rightarrow m(F)^{2n}$, which coincides with S_{q_0} .

Now we are able to give

13.4.20 The proof of Lemma 13.4.7. Let P_* be a projective resolution of finite type. By duality, DP_* is an injective resolution. Hence

$$\begin{aligned} Ext_{\mathcal{F}}^*(F, S^{2n}) &= H^k(Hom_{\mathcal{F}}^*(P_*, S^{2n})) \\ &= H^k((m(DP_*))^{2n}) \\ &= (H^k(m(DP_*)))^{2^k}, \end{aligned}$$

and it is enough to show that $H^k(m(DP_*)) \in \mathcal{N}$. The last inclusion holds because

$$f(H^k(m(DP_*))) = H^k(f \circ m(DP_*)) = H^k(DP_*) = 0, \quad k > 0.$$

□

We now begin the computation for the ring \mathbf{Z} .

13.4.21 Algebraic proof of Bökstedt's computation of $HML^*(\mathbf{Z}, \mathbf{Z})$ (Franjou-Pirashvili [1997]). Here is the strategy for calculation: we first use the change of ring argument for the ring homomorphism $\mathbf{Z} \rightarrow \mathbf{Z}/p\mathbf{Z}$ in order to compute $HML^*(\mathbf{Z}, \mathbf{Z}/p\mathbf{Z})$, then we use the Bockstein spectral sequence to end up the calculation. The multiplicative structure of the spectral sequence is used to calculate the higher order differentials.

13.4.22 Change of Rings. For a small category \mathbf{A} and a ring R we let $\mathbf{A}\text{-}R$ denote the category of functors from \mathbf{A} to R -modules. The proof of Theorem 13.2.10 shows that

$$HML^*(R, T) \cong Ext_{\mathbf{C}\text{-}R}^*(I_R, T).$$

Here \mathbf{C} is the full subcategory of the category $R\text{-}Mod$ containing all R^n , $n \geq 0$; T is in $\mathbf{C}\text{-}R$, and I_R is the inclusion of \mathbf{C} into $R\text{-}Mod$. Indeed, the projective resolution $B(R, Q_*(R), Q_*(-))$ described in Lemma 13.2.12 is also a projective resolution in $\mathbf{C}\text{-}R$. For any functor $U : \mathbf{B} \rightarrow \mathbf{A}$ we denote by $U^* : \mathbf{A}\text{-}R \rightarrow \mathbf{B}\text{-}R$ the precomposition with U . If U has a left adjoint F , then for each $X : \mathbf{A} \rightarrow R\text{-}Mod$ and $Y : \mathbf{B} \rightarrow R\text{-}Mod$ there is an obvious isomorphism:

$$(13.4.22.1) \quad Ext_{\mathbf{B}\text{-}R}^*(U^*X, Y) \cong Ext_{\mathbf{A}\text{-}R}^*(X, F^*Y).$$

For any homomorphism of rings $f : R \rightarrow S$ we would like to take $\mathbf{A} = R\text{-}Mod$, $\mathbf{B} = S\text{-}Mod$, $F = S \otimes_R -$. To avoid set-theoretical difficulties, let us consider only modules whose cardinalities are less than or equal to $\max(\text{Card } \mathbf{N}, \text{Card } R, \text{Card } S)$. We agree that any S -module has a canonical module structure over R , via the homomorphism f . We put $X = I_R$ and obtain the natural isomorphism

$$(13.4.22.2) \quad HML^*(R, Y(S \otimes_R (-))) \cong Ext_{\mathbf{B}\text{-}R}^*(iI_S, Y)$$

where $Y : S\text{-}Mod \rightarrow R\text{-}Mod$ is a functor and for any functor $D : \mathbf{B} \rightarrow S\text{-}Mod$ we let iD denote the same functor as D , but considered as an object in $\mathbf{B} - R$. It follows from the Grothendieck spectral sequence of a composite functor that for any pair of functors $D : \mathbf{B} \rightarrow S\text{-}Mod$ and $E : \mathbf{B} \rightarrow R\text{-}Mod$ one has a spectral sequence

$$E_2^{pq} = Ext_{\mathbf{B}\text{-}S}^p(D, Ext_R^q(S, E(-))) \implies Ext_{\mathbf{B}\text{-}R}^{p+q}(iD, E).$$

Now we take $D = I_S$ and use the isomorphism in 13.4.22.2 in order to get the following *change of ring spectral sequence for Mac Lane cohomology*:

$$(13.4.22.3) \quad E_2^{pq} = HML^p(S, Ext_R^q(S, E(-))) \implies HML^{p+q}(R, f_!E).$$

Here $f_!E \in \mathcal{F}(R)$ is defined by $f_!E = E(S \otimes_R X)$.

Remark that it is compatible with the right $HML^*(S, S)$ -module and left $Ext_{\mathbf{B}\text{-}R}^*(E, E)$ -module actions. In the case, when $E = iI_S$, the spectral sequence has the following form:

$$(13.4.22.4) \quad E_2^{pq} = HML^p(S, Ext_R^q(S, S)) \implies HML^{p+q}(R, S).$$

13.4.23 Proposition. *One has an isomorphism of graded algebras*

$$HML^*(\mathbf{Z}, \mathbf{Z}/p\mathbf{Z}) \cong \Lambda_1 \otimes A^*(\xi_1)$$

where ξ_1 is a class of degree $2p - 1$ and $\Lambda^*(\xi)$ denotes the exterior algebra on a generator ξ .

Proof. Consider the spectral sequence (13.4.22.4) for $\mathbf{Z} \rightarrow \mathbf{Z}/p\mathbf{Z}$:

$$E_2^{pq} = HML^p(\mathbf{Z}/p\mathbf{Z}, Ext_{\mathbf{Z}}^q(\mathbf{Z}/p\mathbf{Z}, \mathbf{Z}/p\mathbf{Z})) \implies HML^{p+q}(\mathbf{Z}, \mathbf{Z}/p\mathbf{Z}).$$

We have $E_2^{pq} = 0$ for $q > 1$. Recall that (see Theorem 13.4.14)

$$HML^*(\mathbf{Z}/p\mathbf{Z}, \mathbf{Z}/p\mathbf{Z}) \cong \Lambda.$$

So $E_2^{*q} \cong Ext_{\mathbf{Z}}^q(\mathbf{Z}/p\mathbf{Z}, \mathbf{Z}/p\mathbf{Z}) \otimes \Lambda$ is a free graded right Λ -module of rank one when $q = 0$ or $q = 1$. It is easy to show that $HML^2(\mathbf{Z}, M) = 0$ for any abelian group M (see for example E.13.2.3 or E.13.1.1). Hence there exists $u \in Ext_{\mathbf{Z}}^1(\mathbf{Z}/p\mathbf{Z}, \mathbf{Z}/p\mathbf{Z})$ such that $d_2(u \otimes 1) = 1 \otimes e_0$. Since d_2 is Λ -linear, we get that $E_{\infty}^{*q} = E_3^{*q}$ is a free right Λ_1 -module of rank 1, whose generators have bidegree $(0, 0)$ and $(2p - 2, 1)$ respectively, for $q = 0$ and 1 respectively. This shows that

$$HML^i(\mathbf{Z}, \mathbf{Z}/p\mathbf{Z}) = \mathbf{Z}/p\mathbf{Z} \text{ if } i \equiv 0, -1 \pmod{2n},$$

$$HML^i(\mathbf{Z}, \mathbf{Z}/p\mathbf{Z}) = 0 \text{ otherwise.}$$

We let ξ denote a generator of $HML^{2p-1}(\mathbf{Z}, \mathbf{Z}/p\mathbf{Z})$. Since

$$HML^{4p-2}(\mathbf{Z}, \mathbf{Z}/p\mathbf{Z}) = 0,$$

we see that $\xi^2 = 0$. On the other hand $HML^*(\mathbf{Z}/p\mathbf{Z}, \mathbf{Z}/p\mathbf{Z})$ is a commutative algebra (thanks to Gerstenhaber [1963]). So one has a homomorphism of algebras $\Lambda_1 \otimes \Lambda^*(\xi_1) \rightarrow HML^*(\mathbf{Z}, \mathbf{Z}/p\mathbf{Z})$. One easily sees that it is an isomorphism by checking the dimensions. \square

13.4.24 Bockstein spectral sequence. Let

$$\begin{array}{ccc} HML^*(\mathbf{Z}, \mathbf{Z}) & \xrightarrow{p} & HML^*(\mathbf{Z}, \mathbf{Z}) \\ & \swarrow & \searrow \\ & HML^*(\mathbf{Z}, \mathbf{Z}/p\mathbf{Z}) & \end{array}$$

be the Bockstein exact couple. It yields the Bockstein spectral sequence $(E_r^*, d_r), r \geq 0$ with $E_0^* = HML^*(\mathbf{Z}, \mathbf{Z}/p\mathbf{Z})$. Since the Bockstein exact couple may be obtained by a short exact sequence of Hochschild cochain complexes

$$0 \longrightarrow C^*(Q_*(\mathbf{Z}), \mathbf{Z}) \xrightarrow{p} C^*(Q_*(\mathbf{Z}), \mathbf{Z}) \longrightarrow C^*(Q_*(\mathbf{Z}), \mathbf{Z}/p\mathbf{Z}) \longrightarrow 0$$

with DG-algebra structure given by the cup-product on $C^*(Q_*(\mathbf{Z}), \mathbf{Z})$, one checks that (E_r^*, d_r) is a DG algebra for any $r \geq 0$.

13.4.25 Lemma. *There exists an isomorphism of graded algebras:*

$$E_r^* \cong \Lambda_r \otimes \Lambda(\xi_r)$$

where $\text{deg}(\xi_r) = 2p^{r+1} - 1$.

Proof. We already observed that the statement is true for $r = 0$. We remark that in the Bockstein exact sequence multiplication by p yields an injection on $HML^*(\mathbf{Z}, \mathbf{Z})$ if $i \not\equiv 0 \pmod{2p}$. This implies

$$HML^{2i-1}(\mathbf{Z}, \mathbf{Z}) = 0.$$

We then work by induction. Let us assume that the statement is true for $r = k$. Hence $E_k^m \cong \mathbf{Z}/p\mathbf{Z}$ for $m \equiv -1, 0 \pmod{2p^{k+1}}$ and $E_k^m = 0$ otherwise. The exact couple

$$\begin{array}{ccc} p^k HML^*(\mathbf{Z}, \mathbf{Z}) & \xrightarrow{p} & p^k HML^*(\mathbf{Z}, \mathbf{Z}) \\ \swarrow & & \searrow \\ & E_k^* & \end{array}$$

shows that the following sequence is exact for $i = 2p^{k+1}t, t \geq 1$:

$$(13.4.25.1) \quad 0 \rightarrow E_k^{i-1} \rightarrow p^k HML^i(\mathbf{Z}, \mathbf{Z}) \xrightarrow{p} p^k HML^i(\mathbf{Z}, \mathbf{Z}) \rightarrow E_k^i \rightarrow 0.$$

By induction assumption

$$E_k^{i-1} \cong \mathbf{Z}/p\mathbf{Z} \cong E_k^i.$$

We take $t = 1$. By E.13.1.5 the p -component of $HML^i(\mathbf{Z}, \mathbf{Z})$ is annihilated by p^{k+1} . Hence the middle homomorphism in (13.4.25.1) vanishes on p -components and we get $d_k(\xi_k) = e_{k+1}$ (up to a scalar), because ξ_k is a generator of E_k^{i-1} and e_{k+1} is a generator of E_k^i . Since $d_k(e_i) = 0$, by a dimension argument we know the values of d_k on whole E_k^i :

$$(13.4.25.2) \quad d_k(x + y\xi_k) = ye_{k+1}, x, y \in \Lambda_k .$$

Thus $\text{Ker } d_k = \Lambda_k \oplus \Lambda_k e_{k+1}^{p-1} \xi_k$ and $\text{Im } d_k = \Lambda_k e_{k+1}$. Hence $E_{k+1}^* \cong \Lambda_{k+1} \otimes \Lambda(\xi_{k+1})$, where ξ_{k+1} is the class of e_{k+1}^{p-1} , whose degree is $2p^{k+2} - 1$ and we get the lemma. □

Now we are in position to prove Bökstedt's theorem.

Proof of theorem 13.4.3. We prove by induction the following statement C_k : the p -component of $HML^i(\mathbf{Z}, \mathbf{Z})$ is equal to $\mathbf{Z}/p^{k+1}\mathbf{Z}$, when $i = 2p^{k+1}t, (t, p) = 1$.

Observe that the validity of C_k for any $k \geq 0$ implies the theorem. By the Bockstein exact sequence and Lemma 13.4.25 for $r = 0$, multiplication by p yields an injection on $HML^*(\mathbf{Z}, \mathbf{Z})$ if $i \not\equiv 0 \pmod{2p}$. This implies

$$HML^{2i-1}(\mathbf{Z}, \mathbf{Z}) = 0$$

and, also, that the statement C_0 holds.

In order to show C_{k+1} assuming C_k , we consider the exact sequence (13.4.25.1). The generator of E_k^{i-1} has the form $y\xi_k$. Then the relation (13.4.25.2) shows that $d_k(y\xi_k) = 0$ if and only if $t \equiv 0 \pmod{p}$. If the condition C_k holds, then $d_k(y\xi_k)$ is a generator of E_k^i . Thus the middle map in (13.4.25.1) is zero on the p -components and we get the condition C_{k+1} . \square

A different proof, which includes the multiplicative structure, was given in Franjou and Pirashvili [1997] :

13.4.26 Theorem. *Let $\Gamma(x)$ be the free divided-power algebra on one generator x of degree 2, that is, the subring of $\mathbf{Q}[x]$, generated by the classes $x^{[i]} = x^i/i!$, $i \geq 1$. Then the algebra $HML^*(\mathbf{Z}, \mathbf{Z})$ is isomorphic to the quotient of the divided-power algebra $\Gamma(x)$ by the ideal generated by the degree 2 class x .*

Exercises

E.13.4.1 A generalized monoidal algebra (GMA) over a commutative ring A is an A -algebra R which is free as an A -module and has a basis \mathbf{B} such that any finite product of elements of \mathbf{B} is again an element of \mathbf{B} or is zero. Monoid algebras and truncated polynomial algebras are examples of GMA. Prove that, if R is a GMA over \mathbf{Z} , then $b \otimes x \mapsto Q_*(\eta_b)(x)$, $b \in \mathbf{B}$ yields a multiplicative chain map

$$R \otimes Q_*(\mathbf{Z}) \longrightarrow Q_*(R)$$

which is a weak equivalence. Here $\eta_b : \mathbf{Z} \rightarrow R$ corresponds to $b \in R$. Deduce from this fact a formula for $HML(R)$ in terms of $HH(R)$ and $HML(\mathbf{Z})$ (see Pirashvili [1994b]).

E.13.4.2 Let R be a ring which is torsion free as abelian group and let $T \in \mathcal{F}(R)$. Let $T' \in \mathcal{F}(\mathbf{Z})$ be the functor defined by $T'(X) = T(X \otimes R)$. Then there is a natural structure of R -bimodule on $HML_{*}(\mathbf{Z}, T')$ and there exists a spectral sequence

$$E_{pq}^2 = H_p(R, HML_q(\mathbf{Z}, T')) \implies HML_{p+q}(R, T).$$

When $T = M \otimes_R -$, the spectral sequence has the following form

$$E_{pq}^2 = H_p(R, HML_q(\mathbf{Z}, M)) \implies HML_{p+q}(R, M).$$

Prove that this spectral sequence collapses when R is a GMA. Prove that all differentials are zero, when R is a smooth \mathbf{Z} -algebra (see Pirashvili [1994b]).

E.13.4.3 Use the change of ring spectral sequence for Mac Lane cohomology for $\mathbf{Z} \rightarrow \mathbf{Z}/p\mathbf{Z}$ and $\mathbf{Z} \rightarrow \mathbf{Z}/p^k\mathbf{Z}$, in order to compute $HML^*(\mathbf{Z}/p^k\mathbf{Z}, \mathbf{Z}/p\mathbf{Z})$ (see Pirashvili [1995]).

E.13.4.4 Show that if $n = p^h$ is a power of a prime p , the right module structure over $HML^*(\mathbf{Z}, \mathbf{Z})$ factors through $HML^*(\mathbf{Z}, \mathbf{Z}/p\mathbf{Z})$, making $HML^*(\mathbf{Z}, Sym^n)$ into a free Λ_h -module on a class of degree 1. In particular:

$$HML^i(\mathbf{Z}, Sym^n) = \mathbf{Z}/p\mathbf{Z} \text{ if } i \equiv 1 \pmod{2n}$$

$$HML^i(\mathbf{Z}, Sym^n) = 0 \text{ otherwise.}$$

Bibliographical Comments on Chapter 13

The cubical construction was introduced in Eilenberg - Mac Lane [1951]. The proof of theorem 13.2.2 given here follows Pirashvili [1996] and is different from the original proof of Eilenberg and Mac Lane which required the two papers [1951] and [1955]. The definition of Mac Lane homology was given in Mac Lane [1956]. Theorem 13.2.10 was proved in Jibladze-Pirashvili [1991].

The category of nonadditive bimodules $\mathcal{F}(R)$ was introduced in Jibladze-Pirashvili [1991], where it was used to interpret Mac Lane cohomology in terms of *Ext* functors. For $R = \mathbf{Z}/p\mathbf{Z}$ this category plays an important role in the theory of unstable modules over the Steenrod algebra (cf. Henn, Lannes and Schwartz [1989] and [1993], as well as Schwartz [1994]). For more on the homology of small categories with coefficients in bifunctors see Baues-Wirsching [1985] and Baues [1988], ch. IV.

Stable K -theory was introduced by Waldhausen [1979], where he also constructed the transformation from stable K -theory to Hochschild homology. A detailed analysis was done by Kassel [1982]. A good reference for the Waldhausen S construction is Waldhausen [1985]. In Kassel [1985] it was proved that the transformation from K_*^s to HH_* mentioned above is an isomorphism in dimensions 0 and 1. Later Goodwillie [1985] proved that, rationally, it is always an isomorphism. It was announced in Waldhausen [1987] that stable K -theory and topological Hochschild homology are isomorphic (see also Schwänzl, Staffeldt and Waldhausen [1996] for the outline of the proof). Dundas and McCarthy [1994] found a more simple proof of the fact that stable K -theory and Mac Lane homology are isomorphic for simplicial rings. Recently Dundas proved the same result for A_∞ -ring spectra. Note that McCarthy [1997] constructed the algebraic K -theory spectrum of an exact category by using Mac Lane's Q -construction.

As said in the introduction topological Hochschild homology is also isomorphic to Mac Lane homology (proved in Pirashvili and Waldhausen [1992]). It was introduced in the nonpublished preprint Bökstedt [1985], where $THH(\mathbf{Z})$ is computed. This theory requires the notion of smash product for spectra, which is quite complicated to define and delicate to apply. The cyclic variant is called topological cyclic homology and the interested reader

may consult Madsen [1992], Bökstedt and Madsen [1994] and the references given there.

References of Chapter 13

- Baues, H.J., “Algebraic homotopy”. Cambridge University Press. 1988.
- Baues, H.J., Quadratic functors and metastable homotopy. *J. Pure Appl. Alg.*, 91 (1994), 49–107
- Baues, H.-J. and Wirsching., G., The cohomology of small categories. *J. Pure Appl. Alg.*, 38 (1985), 187–211
- Betley, S., Calculations in *THH*-theory. *J. Algebra* 180 (1996), 445–458.
- Betley, S. and Pirashvili, T., Stable *K*-theory as a derived functor. *J. Pure Appl. Alg.*, 96 (1994), 245–258.
- Bökstedt, M., Topological Hochschild homology. Preprint, Bielefeld (1985).
- Bökstedt, M., The topological Hochschild homology of \mathbf{Z} and \mathbf{Z}/p . Preprint (1985).
- Bökstedt, M., Hsiang, W.C. and Madsen, I. The cyclotomic trace and algebraic *K*-theory of spaces. *Invent. Math.* 111 (1993), 465–540.
- Bökstedt, M. and Madsen, I., Topological cyclic homology of the integers. *Astérisque*, 226 (1994), 57–143.
- Bökstedt, M. and Madsen, I., Algebraic *K*-theory of local number fields: the unramified case. *Prospects in topology*, *Ann. Math. Studies*, 138 (1995), 28–53.
- Bousfield, A.K. and Friedlander, E.M., Homotopy theory of Γ -spaces, spectra, and bisimplicial sets, *Springer Lecture Notes* 658, (1978), 80–130.
- Breen, L., Extensions du groupe additif. *Publ. IHES*, 48 (1978), 39–125.
- Cartier, P., Une nouvelle opération sur les formes différentielles. *C.R. Acad. Sci. Paris*, 244 (1957), 426–428.
- Dold, A. and Puppe, D., Homologie nicht-additiver Funktoren. *Anwendungen*. *Ann. Inst. Fourier Grenoble*, 11 (1961), 201–312
- Dundas, B.I. and McCarthy, R., Stable *K*-theory and topological Hochschild homology, *Ann. of Math.* 140 (1994), no. 3, 685–701. (*Erratum* 142 (1995), no. 2, 425–426.)
- Dundas, B.I. and McCarthy, R., Topological Hochschild homology of ring functors and exact categories. *J. Pure Appl. Alg.*, 109 (1996), 231–294.
- Eilenberg, S. and Mac Lane, S., Homology theory for multiplicative systems. *Trans. AMS*, 71 (1951), 294–330.
- Eilenberg, S. and Mac Lane, S., On the homology theory of abelian groups. *Canad. J. Math.*, 7 (1955), 43–53.
- Fiedorowicz, Z., Pirashvili, T., Schwänzl, R., Vogt R. and Waldhausen, F., Mac Lane homology and topological Hochschild homology. *Math. Ann.*, 303 (1995), 149–164.

- Franjou, V., Lannes, J. and Schwartz, L., Autour de la cohomologie de Mac Lane des corps finis. *Invent. Math.*, 115 (1994), 513–538.
- Franjou, V. and Pirashvili, T., On Mac Lane cohomology for the ring of integers. To appear in *Topology*.
- Gerstenhaber, M., The cohomology structure of an associative ring, *Ann. of Math.*, 78 (1963), 267–288.
- Goodwillie, T., Calculus of functors I ; II. *K-theory*, 4 (1990), 1–27 ; 5 (1992), 295–332.
- Henn, H.-W., Lannes, J. and Schwartz, L., Analytic functors, unstable algebras and cohomology of classifying spaces. *Algebraic topology* (Evanston, IL, 1988), 197–220, *Contemp. Math.*, 96, Amer. Math. Soc., Providence, RI, 1989.
- Henn, H.-W., Lannes, J. and Schwartz, L., The categories of unstable modules and unstable algebras over the Steenrod algebra modulo nilpotent objects. *Amer. J. Math.*, 115, no. 5 (1993), 1053–1106.
- Hesselholt, L., Stable topological cyclic homology is topological Hochschild homology. *Astérisque*, 226 (1994), 175–192.
- Hesselholt, L. and Madsen, I., On the K -theory of finite algebras over Witt vectors of perfect fields. *Topology*, 36 (1997), 29–101.
- Jibladze, M. and Pirashvili, T., Cohomology of algebraic theories. *J. Algebra*, 137 (1991), 253–296.
- Kassel, C., La K -théorie stable. *Bull. Soc. Math. France*, 110 (1982), 381–416.
- Kuhn, N., Generic representations of the finite general linear groups and the Steenrod algebra, I. *Amer. J. Math.*, 116 (1994), 327–360.
- Kuhn, N., Generic representations of the finite general linear groups and the Steenrod algebra, II. *K-theory*, 8 (1994), 395–428.
- Kuhn, N., Generic representations of the finite general linear groups and the Steenrod algebra, III. *K-theory*, 9 (1995), 273–303.
- Lindenstrauss, A., The topological Hochschild homology of the Gaussian integers. *Amer. Journal of Math.*, 118 (1996), 1011–1036.
- Lydakis, M., Smash-products and F -spaces. preprint, Bielefeld (1996).
- Mac Lane, S., Homologie des anneaux et des modules. *Coll. topologie algébrique*, Louvain (1956), 55–80.
- Madsen, Ib, The cyclotomic trace in algebraic K -theory. First European Congress of Mathematics, Vol. II (Paris, 1992), 213–241, *Progr. Math.*, 120, Birkhäuser, Basel, 1994.
- McCarthy, R., On fundamental theorems of algebraic K -theory. *Topology*, 32 (1993), 325–328.
- McCarthy, R., A chain complex for the spectrum homology of the algebraic K -theory of an exact category, preprint 1997.
- McClure, J.E. and Staffeldt, R.E., On the topological Hochschild homology of bu , I. *Amer. J. Math.*, 115 (1993), 1–45.
- Pirashvili, T., Higher additivizations. *Proc. Math. Inst. Tbilisi.*, 91 (1988), 44–54.

- Pirashvili, T., New homology and cohomology for rings. Bull. Ac. Sc. Georgian SSR, 133 (1989), 55–80.
- Pirashvili, T., Polynomial approximation of *Ext* and *Tor* groups in functor categories. Comm. in Algebra, 21 (1993), 1705–1719.
- Pirashvili, T., On Leibniz homology. Ann. Inst. Fourier, Grenoble, 44 (1994) 401–411.
- Pirashvili, T., Spectral sequence for Mac Lane homology. J. Algebra, 170 (1994) 422–428.
- Pirashvili, T., On the topological Hochschild homology of $\mathbf{Z}/p^k\mathbf{Z}$. Comm. in Algebra, 23 (1995), 1545–1549.
- Pirashvili, T., Kan Extension and stable homology of Eilenberg and Mac Lane spaces. Topology, 35 (1996), 883–886.
- Pirashvili, T. and Waldhausen F., Mac Lane homology and topological Hochschild homology. J. Pure Appl. Alg., 82 (1992), 81–99.
- Schwänzl, R., Staffeldt, R. and Waldhausen, F., Stable *K*-theory and topological Hochschild homology of A_∞ rings. Algebraic *K*-theory (Poznań, 1995), 161–173, Contemp. Math., 199, Amer. Math. Soc., Providence, 1996.
- Schwartz, L., Unstable modules over the Steenrod algebra and Sullivan's fixed point set conjecture. Chicago Lectures in Mathematics. University of Chicago Press, Chicago, IL, 1994. x+229 pp.
- Schwede, S., Stable homotopy of algebraic theories. preprint, Bielefeld (1996).
- Segal, G., Categories and cohomology theories. Topology, 13 (1974), 293–312.
- Song, Y., The Volodin model for Hermitian algebraic *K*-theory. *K*-Theory, 5 (1991/92), no. 6, 485–501.
- Waldhausen, F., Algebraic *K*-theory of topological spaces. I. Algebraic and geometric topology (Proc. Sympos. Pure Math., Stanford Univ., Stanford, Calif., 1976), Part 1, pp. 35–60, Proc. Sympos. Pure Math., XXXII, Amer. Math. Soc., Providence, R.I., 1978.
- Waldhausen, F., Algebraic *K*-theory of topological spaces. II. Algebraic topology, Aarhus 1978 (Proc. Sympos., Univ. Aarhus, Aarhus, 1978), Springer Lecture Notes in Math., 763, (1979), 356–394.
- Waldhausen, F., Algebraic *K*-theory of spaces. Algebraic and geometric topology (New Brunswick, N.J., 1983), 318–419, Springer Lecture Notes in Math., 1126, 1985.
- Waldhausen, F., An outline of how manifolds relate to algebraic *K*-theory. Homotopy theory (Durham, 1985), 239–247, London Math. Soc. Lecture Note Ser., 117, Cambridge Univ. Press, Cambridge-New York, 1987.

Appendix A. Hopf Algebras

The following is a brief summary about the notions of coalgebras and Hopf algebras. One of the results used in this book is the Cartan-Milnor-Moore theorem which gives the structure of a cocommutative Hopf algebra in characteristic zero. We also introduce the notion of shuffle used in the construction of operations in Hochschild and cyclic homology, and in the Künneth type theorem.

The classical references are Milnor-Moore [1965], Quillen [1969, appendix].

Standard Assumption. As usual k denotes a commutative ring.

A.1 Tensor, Symmetric and Exterior Algebras. Let V be a k -module and $V^{\otimes n}$ its n -fold tensor product over k , $V^{\otimes n} = V \otimes V \otimes \dots \otimes V$ (n times). Most of the time a generator $v_1 \otimes \dots \otimes v_n \in V^{\otimes n}$ will be denoted by (v_1, \dots, v_n) or $v_1 v_2 \dots v_n$.

The infinite sum

$$T(V) = k \oplus V \oplus V^{\otimes 2} \oplus \dots \oplus V^{\otimes n} \oplus \dots$$

is called the *tensor module* of V . It can be equipped with two distinct kinds of algebra structure (see below and A.6). One one of them is the following product, called *concatenation*,

$$(v_1, \dots, v_p)(v_{p+1}, \dots, v_n) = (v_1, \dots, v_n),$$

for which $T(V)$ is called the *tensor algebra*. The unit is $1 \in k \subset T(V)$. It is not commutative unless V is one-dimensional, and then $T(V) \cong k[x]$.

Let the symmetric group S_n act on $V^{\otimes n}$ by place permutation,

$$\sigma.(v_1, \dots, v_n) = (v_{\sigma^{-1}(1)}, \dots, v_{\sigma^{-1}(n)}).$$

This is a *left* action (it would be a right action if one put σ instead of σ^{-1}). Note that $\sigma(j)$ indicates the place where the entry v_j goes under the action of σ . The quotient by this action (i.e. factoring out by the equivalence relation $\sigma.x = x$ for all $x \in V^{\otimes n}$ and all $\sigma \in S_n$) gives the symmetric product $S^n(V) := (V^{\otimes n})_{S_n}$. The infinite sum

$$S(V) := \bigoplus_{n \geq 0} S_n(V)$$

is the *symmetric algebra* of V . Note that if V is finite dimensional and free with basis x_1, \dots, x_k , then $S(V)$ is the polynomial algebra $k[x_1, \dots, x_k]$.

If we modify the action of S_n by introducing the sign of the permutation,

$$\sigma.(v_1, \dots, v_n) = \text{sgn}(\sigma)(v_{\sigma^{-1}(1)}, \dots, v_{\sigma^{-1}(n)}),$$

then the new quotient is the exterior module $E^n(V)$. The infinite sum

$$E(V) := \bigoplus_{n \geq 0} E^n(V)$$

is the *exterior algebra* of V . The class of $(v_1, \dots, v_n) \in E^n(V)$ is usually denoted by $v_1 \wedge \dots \wedge v_n$.

Let $V = V_0 \oplus V_1 \oplus V_2 \oplus \dots$ be a non-negatively graded k -module. Let $V^{\text{ev}} := V_0 \oplus V_2 \oplus \dots$ and $V^{\text{odd}} := V_1 \oplus V_3 \oplus \dots$ be the even and odd part respectively. Then the *graded symmetric algebra* of V is

$$\Lambda V = \Lambda^* V := S(V^{\text{ev}}) \otimes E(V^{\text{odd}}).$$

If V is concentrated in degree 1, that is $V = V_1$, then $\Lambda^* V = E(V)$ and $\Lambda^n V = V \wedge \dots \wedge V$. For a permutation $\sigma \in S_n$ and for homogeneous elements v_1, \dots, v_n of V , the associated Koszul sign \pm is such that $v_{\sigma(1)} \wedge \dots \wedge v_{\sigma(n)} = \pm v_1 \wedge \dots \wedge v_n$ in ΛV .

A.2 Coalgebras, Hopf Algebras. By definition a coalgebra R over k is a k -module R equipped with a k -linear map called the *comultiplication*

$$\Delta : R \rightarrow R \otimes R,$$

and a *co-unit* map

$$c : R \rightarrow k,$$

satisfying

- (a) coassociativity: $(id \otimes \Delta) \circ \Delta = (\Delta \otimes id) \circ \Delta$,
- (b) co-unit: $(id \otimes c) \circ \Delta = (c \otimes id) \circ \Delta = id$.

It is a *cocommutative* coalgebra if moreover $\Delta \circ T = \Delta$, where T is the *twisting map* $T(a \otimes b) = b \otimes a$. Note that k is a coalgebra from the natural identification $k \otimes k \cong k$. The tensor product of two coalgebras is naturally equipped with the structure of a coalgebra.

By definition a *Hopf algebra* $\mathcal{H} = (\mathcal{H}, \mu, u, \Delta, c)$ over k is a k -module which is, at the same time, a (unital) k -algebra ($\mu =$ multiplication, $u =$ unit map) and a (counital) k -coalgebra ($\Delta =$ comultiplication, $c =$ counit map), and satisfies the following compatibility conditions

- the multiplication is a coalgebra map or, equivalently, the comultiplication is an algebra map,
- the unit map is a coalgebra map,
- the counit map is an algebra map,

– the composite map $c \circ u : k \rightarrow k$ is id_k .

A map $S : \mathcal{H} \rightarrow \mathcal{H}$ which satisfies the conditions:

$$S^2 = id \quad \text{and} \quad \mu \circ (id \otimes S) \circ \Delta = \mu \circ (S \otimes id) \circ \Delta = id$$

is called an *antipodal map*. Some authors prefer the term *bialgebra* (or even *bigebra*) in place of 'Hopf algebra' and the term *Hopf algebra* in place of 'Hopf algebra with antipodal map'.

A.3 Primitive Part and Indecomposable Part. By definition the *primitive part* of a coalgebra R (with a fixed element 1) is the module

$$\text{Prim } R := \{x \in R \mid \Delta(x) = x \otimes 1 + 1 \otimes x\}.$$

When R is a Hopf algebra the bracket $[x, y] = xy - yx$ of $x, y \in \text{Prim } R$ is still in $\text{Prim } R$ and endows $\text{Prim } R$ with the structure of a Lie algebra over k (exercise: check this). Then Prim becomes a functor from the category of Hopf algebras to the category of Lie algebras. For instance the primitive part of the tensor coalgebra $T'(V)$ is V , and the primitive part of the tensor algebra $T(V)$ is the free Lie algebra on V (cf. for instance Wigner [1989]).

Let A be an augmented k -algebra with augmentation $c : A \rightarrow k$. Define $A^+ = \text{Ker } c$. Then, the *indecomposable part* of A is by definition

$$\text{Indec } A := A^+ / A^+ \cdot A^+.$$

A.4 Group Algebra. Let G be a discrete group and let $k[G]$ be its group algebra over k . Since $k[G] \otimes k[G]$ is identified with $k[G \times G]$, the diagonal map $G \rightarrow G \times G, g \mapsto (g, g)$ induces a comultiplication on $k[G]$. The counit map is given by the augmentation $g \mapsto 1$. This coalgebra is obviously cocommutative. It is immediate to check that it is a Hopf algebra. It is a commutative Hopf algebra iff the group G is abelian. Note that the particular elements $g \in G \subset k[G]$ satisfy the property $\Delta(g) = g \otimes g$. In a general coalgebra, elements satisfying this property are called *group-like* elements.

There is an antipodal map S on $k[G]$ induced by $S(g) = g^{-1}$ for $g \in G$.

A.5 Shuffles, Tensor Algebra. Let $T(V)$ be a tensor algebra. Define a map $\Delta : T(V) \rightarrow T(V) \otimes T(V)$ by the requirements

- (a) $\Delta(1) = 1 \otimes 1,$
- (b) $\Delta(v) = v \otimes 1 + 1 \otimes v, \text{ for } v \in V$
- (c) Δ is a k -algebra map.

Then it is immediate to verify that $T(V)$ becomes a cocommutative Hopf algebra. There is an antipodal map S induced by $S(v) = -v$ for $v \in V$.

The explicit formula for the value of Δ on a generator of dimension n is given by

$$\Delta(v_1, \dots, v_n) = \sum_{\substack{p+q=n \\ \sigma=(p,q)\text{-shuffle}}} (v_{\sigma(1)}, \dots, v_{\sigma(p)}) \otimes (v_{\sigma(p+1)}, \dots, v_{\sigma(p+q)}) .$$

This can be taken as the definition of a (p, q) -shuffle. Explicitly a (p, q) -shuffle is a permutation $\sigma \in S_{p+q}$ such that

$$\sigma(1) < \sigma(2) < \dots < \sigma(p) \quad \text{and} \quad \sigma(p+1) < \sigma(p+2) < \dots < \sigma(p+q) .$$

Most of the classical properties of the shuffles (associativity for instance) can be derived without much computation from this Hopf algebra definition.

Note that the primitive part of $T(V)$ is precisely $V = T^1(V)$.

A.6 Tensor Coalgebra. It is clear that the dual of a Hopf algebra is still a Hopf algebra, but of different nature in general. Let us describe more explicitly the dual of a tensor algebra.

The *tensor coalgebra* $T'(V)$ is the tensor module $T(V)$ equipped with the coalgebra map called *deconcatenation* (or *cut product*),

$$\Delta(v_1, \dots, v_n) = \sum_{p=0}^n (v_1, \dots, v_p) \otimes (v_{p+1}, \dots, v_n) ,$$

It becomes a Hopf algebra when equipped with the multiplication map

$$\mu((v_1, \dots, v_p) \otimes (v_{p+1}, \dots, v_{p+q})) = \sum_{\substack{p+q=n \\ \sigma=(p,q)\text{-shuffle}}} (v_{\sigma^{-1}(1)}, \dots, v_{\sigma^{-1}(n)}) \in V^{\otimes n} .$$

Thus $T'(V)$ is a commutative Hopf algebra. The primitive part of $T'(V)$ is the free Lie algebra on V .

A.7 Graded Algebras. The definitions of algebras, coalgebras and Hopf algebras can be carried over to the graded framework and in the graded differential framework. Let us treat the case of non-negatively graded algebras.

A *(non-negatively) graded k -algebra* A is a graded k -module

$$A = A_0 \oplus A_1 \oplus A_2 \oplus \dots$$

equipped with a product structure $\mu : A \otimes A \rightarrow A$ which sends $A_i \otimes A_j$ into A_{i+j} . As usual $\mu(a \otimes b)$ is simply denoted by ab . If A has a unit $1_A = 1$, then $1 \in A_0$. Let $T : A \otimes A \rightarrow A \otimes A$ be the *graded twisting map* given by $T(a \otimes b) = (-1)^{pq}(b \otimes a)$ for $a \in A_p$ and $b \in A_q$. Then A is said to be *graded commutative* if $\mu \circ T = \mu$. An *augmentation* of A is a graded morphism $\varepsilon : A \rightarrow k$, where k is concentrated in degree 0. The graded unital algebra A is said to be *connected* when the map $k \rightarrow A_0, \lambda \mapsto \lambda 1_A$ is an isomorphism. Note that a connected algebra is augmented.

If, in the definition of the tensor algebra, one considers V as a graded module concentrated in degree 1, then $T(V)$ becomes a graded algebra. The formula for the coalgebra map is slightly altered by the introduction of the sign. A similar modification applies in the tensor coalgebra case.

A.8 Differential Graded Algebras. Let A be a non-negatively graded k -algebra. Let $d : A_n \rightarrow A_{n-1}$, $n > 0$, be a k -linear map which satisfies

- (a) $d^2 = 0$,
- (b) $d(ab) = (da)b + (-1)^p a(db)$, for $a \in A_p$ and $b \in A_q$.

The map d is called a *differential map* and the pair (A, d) is called a *differential graded algebra*. The following sequence

$$\dots \rightarrow A_n \xrightarrow{d} A_{n-1} \rightarrow \dots \rightarrow A_1 \rightarrow A_0$$

is a complex (A_*, d) of k -modules whose homology is denoted by $H_n(A, d)$ or simply $H_n(A)$.

We leave to the reader the task of defining the graded and differential notions for coalgebras, Hopf algebras, Lie algebras (cf. Sect. 10.1). Note that the notions of commutativity and cocommutativity require the graded twisting map.

If (C, d) is a complex, that is a differential graded module, then $T(C, d)$ is still a differential graded module, whose differential is given by

$$d(x_1, \dots, x_n) = \sum_i \pm(x_1, \dots, x_{i-1}, dx_i, x_{i+1}, \dots, x_n) .$$

Notation. It is useful to abbreviate 'differential graded algebra' to DG-algebra and similarly to replace 'commutative' by C, 'cocommutative' by Co and 'Hopf' by H. So a CDGH-algebra is a commutative differential graded Hopf algebra.

A.9 Theorem (Cf. Quillen [1969 Appendix 2]). *On CoDGH-algebras \mathcal{H} over a characteristic zero field k the homology and primitive functors commute,*

$$H(\text{Prim } \mathcal{H}) \cong \text{Prim } H(\mathcal{H}) . \quad \square$$

As noted in A.3 the primitive part of a Hopf algebra \mathcal{H} is a Lie algebra. The inclusion $\text{Prim } \mathcal{H} \hookrightarrow \mathcal{H}$ can be extended to a canonical map

$$U(\text{Prim } \mathcal{H}) \rightarrow \mathcal{H}, \quad (g_1, \dots, g_n) \mapsto g_1 g_2 \dots g_n ,$$

where U is the universal enveloping algebra functor from the category of Lie algebras to the category of associative algebras (cf. 10.1.2).

A.10 Theorem of Cartan-Milnor-Moore (cf. Quillen [1969, Appendix 2]). *Let \mathcal{H} be a connected cocommutative GH- (resp. DGH-) algebra over a characteristic zero field k . Then the canonical map*

$$U(\text{Prim } \mathcal{H}) \rightarrow \mathcal{H}$$

is an isomorphism of GH- (resp. DGH-) algebras.

Note that everything is taken in the graded sense, including the Lie algebras and the functor U . If \mathcal{H} is commutative, then the graded Lie algebra $\text{Prim } \mathcal{H}$ is graded commutative and U is simply the graded symmetric algebra functor. In this case the Cartan-Milnor-Moore theorem becomes

$$\Lambda \text{Prim } (\mathcal{H}) \cong \mathcal{H} .$$

A.11 H -Spaces. Let X be a connected H -space (e.g. the loop space of a simply connected space or a connected topological group) with homotopy groups $\pi_*(X)$ and homology groups $H_*(X, k)$ where k is a characteristic zero field. The diagonal map induces (via the Künneth isomorphism) a comultiplication on $H_*(X, k)$ and the H -space map induces a multiplication. Then $H_*(X, k)$ becomes a graded Hopf algebra. A classical theorem of Milnor and Moore [1965] asserts that the Hurewicz homomorphism induces an isomorphism

$$\pi_*(X) \otimes k \cong \text{Prim } H_*(X, k) .$$

Appendix B. Simplicial

The aim of this appendix is to give the principal definitions, constructions and theorems on simplicial objects which are used throughout the book. In fact simplicial modules are treated in Sect.6 of Chap.1 and therefore this appendix is mostly devoted to simplicial sets and spaces. The last part is about bisimplicial sets. Proofs can be found in May [1967], Bousfield-Kan [1972], Gabriel-Zisman [1967], Quillen [1973a, 1].

B.1 The Simplicial Category Δ . Let $[n]$ be the ordered set of $n + 1$ points $\{0 < 1 < \dots < n\}$. The map $f : [n] \rightarrow [m]$ is *non-decreasing* if $f(i) \geq f(j)$ whenever $i > j$. The category Δ is the category with objects $[n]$, for $n \geq 0$ and with non-decreasing maps for morphisms. Remark that the only isomorphisms in Δ are the identities $1_{[n]}$ because a non-decreasing map which is a bijection is the identity.

It is usual to focus on some particular morphisms, the faces $\delta_i : [n-1] \rightarrow [n]$ and the degeneracies $\sigma_j : [n+1] \rightarrow [n]$ defined as follows. The map δ_i is an injection which misses i ($0 \leq i \leq n$). The map σ_j is a surjection which sends both j and $j + 1$ to j . They are important morphisms in view of the following structure theorem.

B.2 Theorem. *For any morphism $\phi : [n] \rightarrow [m]$ there is a unique decomposition*

$$\phi = \delta_{i_1} \delta_{i_2} \dots \delta_{i_r} \sigma_{j_1} \sigma_{j_2} \dots \sigma_{j_s}$$

such that $i_1 \leq i_2 \leq \dots \leq i_r$ and $j_1 < j_2 < \dots < j_s$ with $m = n - s + r$. (It is understood that if the set of indices is empty then ϕ is the identity). \square

To be precise one should make it clear which n is involved when writing δ_i (or σ_j) but the context is always sufficient to clear the ambiguity.

B.3 Corollary. *The category Δ is presented by the generators δ_i , $0 \leq i \leq n$ and σ_j , $0 \leq j \leq n$ (one for each n) subject to the relations*

$$\delta_j \delta_i = \delta_i \delta_{j-1} \quad \text{for } i < j,$$

$$\sigma_j \sigma_i = \sigma_i \sigma_{j+1} \quad \text{for } i \leq j,$$

$$\sigma_j \delta_i = \begin{cases} \delta_i \sigma_{j-1} & \text{for } i < j, \\ id_{[n]} & \text{for } i = j, i = j + 1, \\ \delta_{i-1} \sigma_j & \text{for } i > j + 1. \end{cases}$$

□

B.4 Simplicial Objects. Let \mathcal{C} be a category (in our examples it will essentially be the category of sets or of spaces or of k -modules). By definition a *simplicial object* in \mathcal{C} is a functor

$$X = X_\bullet : \Delta^{\text{op}} \rightarrow \mathcal{C}$$

where Δ^{op} is the opposite category of Δ . Equivalently one can think of X as being a *contravariant* functor from Δ to \mathcal{C} . The image of a morphism ϕ in Δ by X is denoted by $X(\phi)$ or by ϕ^* . If f is a morphism of Δ^{op} , then one simply denotes its image by f .

A functor $Y : \Delta \rightarrow \mathcal{C}$ is called a *cosimplicial object* in \mathcal{C} .

Theorem B.2 and Corollary B.3 allow us to give another description of a simplicial object.

A simplicial object X_\bullet is a set of objects $X_n, n \geq 0$, in \mathcal{C} and a set of morphisms $d_i : X_n \rightarrow X_{n-1} (0 \leq i \leq n), s_j : X_n \rightarrow X_{n+1} (0 \leq j \leq n)$, for all $n \geq 0$, satisfying the following formulas

$$\begin{aligned} d_i d_j &= d_{j-1} d_i \quad \text{for } i < j, \\ s_i s_j &= s_{j+1} s_i \quad \text{for } i \leq j, \\ d_i s_j &= \begin{cases} s_{j-1} d_i & \text{for } i < j, \\ id_{X_n} & \text{for } i = j, \quad i = j + 1, \\ s_j d_{i-1} & \text{for } i > j + 1. \end{cases} \end{aligned}$$

Obviously one has $X_n = X([n]), d_i = \delta_i^*$ and $s_j = \sigma_j^*$. When $\mathcal{C} = (\mathbf{Sets})$ the object X_n is called the *n-skeleton* and its elements are called the *n-simplices* of X . We let the reader to write the analogous description of a cosimplicial object.

When the degeneracy maps are ignored, then such an object is called a *pre-simplicial object*.

The main examples used in this book are the categories of k -modules, of sets and of spaces, whence the notion of simplicial module, simplicial set and simplicial space. In this latter case we always suppose that the spaces X_n are absolute neighborhood retracts (ANR) in order to avoid pathological situations, see B.8.

B.5 Simplicial Modules. To any simplicial module is associated a complex (M_\bullet, d) , where

$$d = \sum_{i=0}^n (-1)^i d_i .$$

The relation $d^2 = 0$ is a consequence of the relations $d_i d_j = d_{j-1} d_i$. In fact it suffices to have a presimplicial module to construct the complex (M_*, d) . The homology groups are denoted $H_n(M_*, d)$ or simply $H_n(M)$, $n \geq 0$. Elementary properties of this complex have been recalled in 1.0.6 to 1.0.9. Other properties of simplicial modules are worked out in Sect. 1.6.

B.6 The Geometric n -Simplex and the Cosimplicial Space Δ . The topological space $\Delta^n := \{(t_0, \dots, t_n) \in \mathbb{R}^{n+1} \mid 0 \leq t_i \leq 1, \text{ all } i \text{ and } \sum t_i = 1\}$ is called the *geometric n -simplex*.

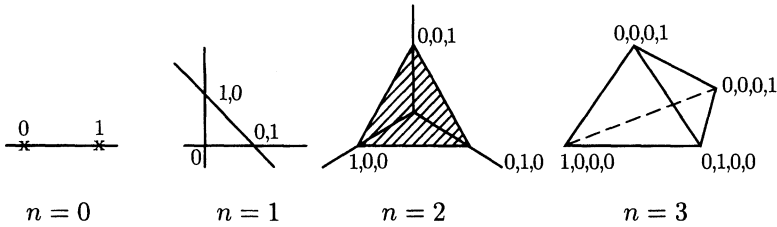

The functor $\Delta : \Delta \rightarrow (\mathbf{Spaces})$, $[n] \mapsto \Delta^n$ is a cosimplicial space. Indeed it suffices to check that $\delta_i(t_0, \dots, t_{n-1}) = (t_0, \dots, t_{i-1}, 0, t_i, \dots, t_{n-1})$ and that $\sigma_j(t_0, \dots, t_{n+1}) = (t_0, \dots, t_{j-1}, t_j + t_{j+1}, t_{j+2}, \dots, t_{n+1})$ satisfy the formulas of B.3. □

B.7 Geometric Realization of a Simplicial Set. If X is a simplicial space (a set is considered as a discrete space) and Y is a cosimplicial space, their product over Δ (analogous to the tensor product) is the quotient space

$$X \times_{\Delta} Y = \bigcup_{n \geq 0} X_n \times Y_n / \approx$$

where the equivalence relation \approx is generated by

$$(x, \phi_*(y)) \approx (\phi^*(x), y) \text{ for any } x \in X_n, y \in Y_m \text{ and any } \phi : [m] \rightarrow [n] \text{ in } \Delta.$$

Note that $X_n \times Y_n$ is given the topology of the product.

In particular the *geometric realization* of X is by definition the space $|X| = X \times_{\Delta} \Delta$. In other words

$$|X| = \bigcup_{n \geq 0} X_n \times \Delta^n / \approx .$$

In order to figure out what the geometric realization of a simplicial set is, the following remark is quite useful. An element $x \in X_n$ is called *degenerate* if there is some $z \in X_{n-1}$ such that $x = s_j(z)$ for some j . Then, as a CW-complex, the geometric realization of X is a union of cells, which are in bijection with the non-degenerate simplices. The face operators tell us how these cells are glued together to form $|X|$.

The geometric n -simplex is itself the geometric realization of a simplicial set. Let p be a fixed positive integer and let $\Delta[p]$ be the simplicial set defined by $(\Delta[p])_n = \text{Hom}_\Delta([n], [p])$. Then the evaluation map $(f, t) \mapsto f_*(t)$ for $f \in (\Delta[p])_n$ and $t \in \Delta^n$ permits us to identify $|\Delta[p]|$ with Δ^p .

For a description of simplicializations of the circle S^1 see 7.1.2 and 7.3.2.

The geometric realization functor $|\cdot|$ is a functor from the category of simplicial sets to the category of spaces. In the other direction there is the *singular complex functor* which is defined as follows. For any space X let

$$\mathcal{S}_n(X) := \{f : \Delta^n \rightarrow X \mid f \text{ is continuous}\} .$$

The cosimplicial structure of Δ^\cdot induces a simplicial structure on $\mathcal{S}_\cdot(X)$. The two functors $|\cdot|$ and \mathcal{S} are adjoint,

$$\text{Hom}_{(\mathbf{Spaces})}(|K|, X) \cong \text{Hom}_{(\mathbf{Simpl})}(K, \mathcal{S}(X)) .$$

For any two simplicial sets X and Y , there is a canonical homeomorphism $|X| \times |Y| \cong |X \times Y|$ where the product $X \times Y$ is such that $(X \times Y)_n = X_n \times Y_n$, provided that $|X| \times |Y|$ is a CW-complex.

B.8 Geometric Realization of Simplicial Spaces. By simplicial space we mean “good simplicial space” in the sense of G. Segal [1974, appendix A]. In particular the horizontal (resp. vertical) realization of a bisimplicial set is “good”. This ensures that a map of simplicial spaces $X \rightarrow Y$, which, for each $n \geq 0$, is a homotopy equivalence $X_n \rightarrow Y_n$, induces a homotopy equivalence $|X| \rightarrow |Y|$.

B.9 Kan Fibration and Kan Complex. A simplicial map $p : E \rightarrow B$ is said to be a *Kan fibration* if it satisfies the following extension condition:

- for every collection of n -simplices $x_0, \dots, x_{k-1}, x_{k+1}, \dots, x_{n+1}$ in E_n which satisfy the compatibility condition $d_i x_j = d_{j-1} x_i, i < j, i \neq k, j \neq k$, and for every simplex y in B_{n+1} such that $d_i y = p(x_i), i \neq k$, there exists a simplex x in E_{n+1} such that $d_i x = x_i, i \neq k$ and $p(x) = y$.

Let $x_0 \in E_0$ be a point and let $b_0 = p(x_0)$ be its image in B . Then the inverse image $F := p^{-1}(b_0)$ of the subsimplicial set generated by b_0 is a simplicial set with base point x_0 . F is called the (simplicial) *fiber* of p at b_0 . When p is a Kan fibration the following sequence is a Serre fibration

$$(|F|, x_0) \rightarrow (|E|, x_0) \rightarrow (|B|, b_0) .$$

For instance a simplicial group homomorphism, which is surjective in each dimension, is a Kan fibration.

If, in the definition of a Kan fibration, one ignores the condition relative to B and p , then E is called a *Kan complex*. Let X and Y be two simplicial sets and suppose that Y is a Kan complex. Then there is a natural homotopy equivalence

$$|\text{HOM}(X, Y)| \sim \text{Map}(|X|, |Y|),$$

where $\text{HOM}(\cdot, \cdot)$ is the “simplicial set Hom-functor”:

$$\text{HOM}(X, Y)_n = \text{Hom}_{(\mathbf{Simp})}(X \times \Delta[n], Y).$$

B.10 Simplicial Homology. Let k be a commutative ring. Any set E gives rise to a free k -module $k[E]$ with basis E , so any simplicial set X gives rise to a simplicial module $k[X]$. Since any simplicial module gives rise to a complex and hence to homology groups, one gets $H_*(k[X])$ called the *simplicial homology* of X .

The following result relates simplicial homology and singular homology.

B.11 Theorem. *Any simplicial set X gives rise to a simplicial module $k[X]$ and there is a canonical isomorphism*

$$H_*(k[X]) \cong H_*(|X|, k),$$

where the latter group is singular homology of the topological space $|X|$. \square

B.12 Nerve and Classifying Space of a Category. Let \mathcal{C} be a *small category*, i.e. a category whose objects form a set denoted $\text{Ob } \mathcal{C}$. Put

$$\text{Mor}_n \mathcal{C} = \{C_0 \xrightarrow{f_0} C_1 \xrightarrow{f_1} \dots \xrightarrow{f_{n-1}} C_n \mid C_i \in \text{Ob } \mathcal{C}, f_i \in \text{Mor } \mathcal{C}\}.$$

The functor $\Delta^{\text{op}} \rightarrow (\mathbf{Sets})$ given by $[n] \mapsto \text{Mor}_n \mathcal{C}$ is well-defined and determines a simplicial set $B\mathcal{C}$ called the *nerve* of the small category \mathcal{C} . The *classifying space* BC of the small category \mathcal{C} is, by definition, the geometric realization of the nerve of \mathcal{C} , $BC = |B\mathcal{C}|$.

Example 1. Let G be a (discrete) group. It can be considered as a category “ G ” with only one object $*$, with morphisms the elements of G and composition equal to the group-law. The nerve of “ G ” is denoted by $B.G$. It is given by $B_n G = G^n$ and

$$d_i(g_1, \dots, g_n) = \begin{cases} (g_2, \dots, g_n) & \text{for } i = 0, \\ (g_1, \dots, g_i g_{i+1}, \dots, g_n) & \text{for } 1 \leq i \leq n - 1, \\ (g_1, \dots, g_{n-1}) & \text{for } i = n - 1, \end{cases}$$

$$s_j(g_1, \dots, g_n) = (g_1, \dots, g_i, 1, g_{i+1}, g_n).$$

The classifying space of “ G ” is $BG := |B.G|$. It is an Eilenberg-Mac Lane space of type $K(G, 1)$, i.e. a connected space such that $\pi_i(BG) = 0$ for $i > 0$ and $\pi_1(BG) = G$. One way to prove this statement is as follows.

Let “ EG ” be the category whose objects are the elements of G and which has one and only one morphism from one object to any other one. Denote by $E.G$ the nerve and by EG the classifying space. Obviously EG is contractible

(there exists an initial object in “ EG ”) and G acts freely on “ EG ”, hence on EG . The quotient by this action is precisely BG , whence a fibration

$$G \rightarrow EG \rightarrow BG .$$

The same construction can be performed with a topological group G . In this case the nerve is a simplicial space and the classifying space is not a $K(\pi, 1)$ any more. For instance if $G = S^1$, then $BS^1 = K(\mathbb{Z}, 2)$.

Example 2. Let G be a topological group (it may be discrete) and let X be a topological G -space. There is defined a topological category as follows. The objects are the elements of X , a morphism from $x \in X$ to $x' \in X$ is an element of g such that $g \cdot x = x'$. Then the nerve of this category is a simplicial space equal to $G^n \times X$ in dimension n . Its geometric realization is the Borel space $EG \times_G X$.

B.13 Bousfield-Kan Construction and Homotopy Colimit (see also C.10). Let $F : \mathcal{C} \rightarrow (\mathbf{Sets})$ be a functor from a small category \mathcal{C} to the category of sets. There is a way of associating to it a classifying space as follows. First one constructs a category \mathcal{C}_F with objects the pairs (C, x) where C is an object of \mathcal{C} and $x \in F(C)$. A morphism from (C, x) to (C', x') is a morphism $f : C \rightarrow C'$ in \mathcal{C} such that $f_*(x) = x'$. By definition the *homotopy colimit* of the functor F is the space

$$\text{hocolim } F := BC_F ,$$

that is the geometric realization of the category \mathcal{C}_F . This is also called the *Bousfield-Kan construction*. Note that if the functor F is trivial ($F(C) = \{*\}$ for all $C \in \text{Ob } \mathcal{C}$), then this is nothing but BC .

When the category of sets is replaced by the category of spaces the nerve of the category is a simplicial space.

Example 1. Let $\mathcal{C} = \{0 \rightarrow 1\}$ be the category with two objects 0 and 1 and only one non-trivial morphism. A functor $X : \{0 \rightarrow 1\} \rightarrow (\mathbf{Spaces})$ is completely determined by a continuous map $f : X_0 \rightarrow X_1$. Then the space BC_X is the classical cylinder of f . Note that when f is a cofibration X_1 , which is the colimit of X , is homotopy equivalent to the cylinder of f (that is the homotopy colimit of X).

Example 2. Let $\mathcal{C} = \{0 \rightarrow 1 \rightarrow 2 \rightarrow \dots\}$ be the category of indices (one and only one map from i to j , $i \leq j$). A functor $X : \mathcal{C} \rightarrow (\mathbf{Spaces})$ is completely determined by the sequence of continuous maps (inductive system):

$$X_0 \rightarrow X_1 \rightarrow \dots \rightarrow X_n \rightarrow \dots .$$

The space $\text{hocolim } X$ is called the *telescope* of the inductive system. There is a natural map $\text{colim } X \rightarrow \text{hocolim } X$ which is a homotopy equivalence when all the maps are cofibrations.

Example 3. For $C = \Delta^{\text{op}}$ one has two spaces associated to the simplicial space $X : \Delta^{\text{op}} \rightarrow (\mathbf{Spaces})$, the usual geometric realization and the homotopy colimit. In Bousfield and Kan [1972] it is proved that for any such simplicial space (with X_n an ANR) there is a canonical homotopy equivalence $\text{hocolim } X \rightarrow |X|$.

Example 4. For $C = \Delta$ the homotopy limit gives a notion of geometric realization for cosimplicial spaces.

The main advantage of the homotopy colimit versus the classical colimit is in the following result.

B.14 Proposition. *Let F and F' be two (good) functors from C to (\mathbf{Spaces}) and let $\alpha : F \rightarrow F'$ be a transformation of functors. If for any $C \in \text{Ob}(C)$ the map $\alpha(C) : F(C) \rightarrow F'(C)$ is a homotopy equivalence, then $BC_F \rightarrow BC_{F'}$ is a homotopy equivalence. \square*

A similar statement is valid with (\mathbf{Spaces}) replaced by $(k\text{-Mod})$ and homotopy equivalence replaced by quasi-isomorphism.

B.15 Bisimplicial Objects. By definition a *bisimplicial object* in a category C is a functor

$$X = X_{..} : \Delta^{\text{op}} \times \Delta^{\text{op}} \rightarrow C .$$

Such a bisimplicial object can be described equivalently by a family of objects $C_{pq}, p \geq 0, q \geq 0$, together with *horizontal* and *vertical* faces and degeneracies

$$\begin{aligned} d_i^h : C_{pq} &\rightarrow C_{p-1q}, & s_i^h : C_{pq} &\rightarrow C_{p+1q}, & 0 \leq i \leq p \\ d_i^v : C_{pq} &\rightarrow C_{pq-1}, & s_i^v : C_{pq} &\rightarrow C_{pq+1}, & 0 \leq i \leq q, \end{aligned}$$

which satisfy the classical simplicial relations horizontally, vertically, and such that horizontal and vertical operators commute.

For any bisimplicial set X there are three natural ways to make a geometric realization. One can realize horizontally (to get a simplicial space) and then realize vertically, or the other way round, or one can make the geometric realization of the diagonal simplicial set $[n] \mapsto X_{nn}$ (with $d_i = d_i^h d_i^v$, etc.). It turns out that these three constructions yield canonically homeomorphic spaces (denoted without distinction by $|X|$):

$$|[n] \mapsto |X_{..}| \cong |[n] \mapsto X_{nn}| \cong |[n] \mapsto |X_n| .$$

Any bisimplicial module $M_{..}$ gives rise to a bicomplex M_{**} with horizontal differential

$$\sum_{i=0}^n (-1)^i d_i^h$$

and vertical differential

$$(-1)^n \sum_{i=0}^n (-1)^i d_i^v .$$

Therefore this gives two spectral sequences to compute $H_*(\text{Tot } M_{**})$ (cf. Appendix D on spectral sequences).

Note that any bisimplicial set X gives rise to a bisimplicial module $k[X]$ and $H_*(|X|, k) = H_*(\text{Tot } k[X])$. So there are two spectral sequences to compute the singular homology of $|X|$.

Appendix C. Homology of Discrete Groups and Small Categories

In this appendix we give a brief summary of some essential facts about the homology of discrete groups and small categories as needed in the text. Proofs and more comprehensive material can be found in classical books on homological algebra (cf. Cartan-Eilenberg [CE], Mac Lane [ML], Bourbaki [1980]) or in some more specialized books like K.Brown [1982]. For the small category case see Quillen [1973,

1].

C.1 Group Algebras and G -Modules. Let G be a (discrete) group and let $k[G]$ be its associated *group algebra* over the commutative ring k . The functor $G \mapsto k[G]$ from the category of groups to the category of unital k -algebras is adjoint to the unit functor $A \mapsto A^\times = \{\text{invertible elements of } A\}$:

$$\text{Hom}_{\mathbf{Grp}}(G, A^\times) \cong \text{Hom}_{k\text{-Alg}}(k[G], A)$$

By definition a *right G -module* M over k is a right $k[G]$ -module and similarly for left and bi-modules. For any $m \in M$ and any $g \in G$ the result of the right action of g on m is denoted by mg (or sometimes m^g). Note that if G is considered as a category “ G ” (see B.12 Example 1), then a left (resp. right) G -module can be considered as a functor (resp. contravariant functor) from “ G ” to $(k\text{-Mod})$.

C.2 Homology of a Discrete Group with Coefficients. Let M be a right G -module over k and let $C_n(G, M) := M \otimes k[G^n] = M \otimes k[G]^{\otimes n}$ be the *module of n -chains of G with coefficients in M* . The map $d : C_n(G, M) \rightarrow C_{n-1}(G, M)$ given by

$$d(g_0, \dots, g_n) = (g_0g_1, g_2, \dots, g_n) - (g_0, g_1g_2, \dots, g_n) + \dots \\ \dots + (-1)^n(g_0, g_1, \dots, g_{n-1}),$$

where $g_0 \in M$ and $g_i \in G$ otherwise, is a boundary map ($d^2 = 0$). Therefore $(C_\star(G, M), d)$ is a complex called the *Eilenberg-Mac Lane complex*. By definition its homology, denoted $H_n(G, M)$, is called the *homology of G with coefficients in M* . Note that $H_0(G, M) = M \otimes_{k[G]} k = M_G$ is the coinvariant module of M by the action of G , that is M divided by the submodule generated by the elements $mg - m$, $m \in M$, $g \in G$.

When M is the trivial G -module k one often writes $C_*(G)$ and $H_*(G)$ instead of $C_*(G, k)$ and $H_*(G, k)$ respectively. Note that $H_0(G) = k$ and $H_1(G) = G/[G, G] = G_{\text{ab}} \otimes k$ is the abelianization of G tensored by k .

C.3 Standard Resolution and Tor-Interpretation. The EM -complex is in fact the tensor product $C_*(G, M) = M \otimes_G C_*^{\text{bar}}(G)$ of M with the bar complex over G . This *bar complex* $C_*^{\text{bar}}(G) = C_*(G, k[G])$ (where $k[G]$ is viewed as a right module over itself) is a free resolution of the trivial G -module k and is often called the *standard resolution*. This shows that

$$H_n(G, M) \cong \text{Tor}_n^{k[G]}(M, k), \text{ for all } n \geq 0.$$

If M is a left G -module one puts M on the right-hand side in the definition of $C_*(G, M)$ and the above isomorphism becomes $H_n(G, M) \cong \text{Tor}_n^{k[G]}(k, M)$.

C.4 Homology of Cyclic Groups. For a particular group it is often easier to choose an ad hoc resolution to compute the homology. For instance, let $G = \mathbb{Z}$ be the infinite cyclic group with generator t . Then $k[\mathbb{Z}] = k[t, t^{-1}]$ and the following sequence

$$\dots \rightarrow 0 \rightarrow 0 \rightarrow k[t, t^{-1}] \xrightarrow{1-t} k[t, t^{-1}] \xrightarrow{\text{aug}} k \rightarrow 0$$

is a free resolution of the trivial $k[\mathbb{Z}]$ -module k . Hence $H_0(\mathbb{Z}) = k$, $H_1(\mathbb{Z}) = k$ and $H_i(\mathbb{Z}) = 0$ for $i \geq 2$.

Now let $G = \mathbb{Z}/n\mathbb{Z}$ be the finite cyclic group of order n . Then, when n is regular in k (e.g. $k = \mathbb{Z}$), there is a free resolution which is periodic of period 2:

$$\dots \rightarrow k[\mathbb{Z}/n\mathbb{Z}] \xrightarrow{1-t} k[\mathbb{Z}/n\mathbb{Z}] \xrightarrow{N} k[\mathbb{Z}/n\mathbb{Z}] \xrightarrow{1-t} k[\mathbb{Z}/n\mathbb{Z}] \xrightarrow{\text{aug}} k \rightarrow 0,$$

where $N = 1 + t + t^2 + \dots + t^{n-1}$ is the *norm map* (cf. Exercise E.1.0.2). When n is invertible in k the maps

$$h = -\frac{1}{n} \sum_{i=1}^{n-1} it^i \quad \text{and} \quad h' = \frac{1}{n} \text{id}$$

give a homotopy of the identity to 0 since

$$h(1-t) + Nh' = h'N + (1-t)h = t^n = \text{id}.$$

As a consequence, for any $\mathbb{Z}/n\mathbb{Z}$ -module M the homology of the complex

$$\dots \rightarrow M \xrightarrow{1-t} M \xrightarrow{N} M \xrightarrow{1-t} M,$$

is precisely $H_*(\mathbb{Z}/n\mathbb{Z}, M)$. If n is invertible in the ground ring k (e.g. k contains \mathbb{Q}), then these groups are 0 except for $*$ = 0 for which $H_0(\mathbb{Z}/n\mathbb{Z}, M) = M_{\mathbb{Z}/n\mathbb{Z}}$.

Obviously one can extend this sequence periodically on the right. This gives rise to a new complex, whose homology is called *Tate homology* of $\mathbb{Z}/n\mathbb{Z}$ with coefficients in M , and which is denoted by $\hat{H}_*(\mathbb{Z}/n\mathbb{Z}, M)$. For a generalization to any group (not just even finite), due to P. Vogel, see Goichot [1992].

C.5 Topological Interpretation. From the simplicial interpretation of the classifying space of a discrete group (cf. Appendix B) it is clear that there is a canonical isomorphism

$$H_*(G, M) \cong H_*(BG, M),$$

where the latter group is singular homology of the classifying space BG (which is an Eilenberg-Mac Lane space of type $K(G, 1)$). For instance if $G = \mathbb{Z}$, then $B\mathbb{Z}$ is homotopy equivalent to the circle S^1 . Note that the bar resolution of G is in fact the complex associated to the universal cover EG of BG and the acyclicity of this complex corresponds to the contractibility of EG .

Any extension of discrete groups

$$1 \rightarrow G' \rightarrow G \rightarrow G'' \rightarrow 1$$

gives rise to a Kan fibration by taking the nerve, and then to a topological fibration

$$BG' \rightarrow BG \rightarrow BG''.$$

The homology spectral sequence of a fibration (cf. Appendix D) reduces, in this case, to the Hochschild-Serre spectral sequence of an extension of groups:

$$E_{pq}^2 = H_p(G'', H_q(G')) \Rightarrow H_{p+q}(G).$$

C.6 Cohomology of Discrete Groups. The *cohomology groups* of G with coefficients in the left G -module M are the homology groups $H^*(G, M)$ of the complex $(C^*(G, M), \delta)$ where $C_n(G, M)$ is the module of functions f from G^n to M and the boundary map $\delta : C^{n-1}(G, M) \rightarrow C^n(G, M)$ is given by

$$\begin{aligned} (\delta(f))(g_1, \dots, g_n) &= g_1 f(g_2, \dots, g_n) - f(g_1 g_2, \dots, g_n) + \dots \\ &\dots + (-1)^n f(g_1, \dots, g_{n-1}). \end{aligned}$$

The interpretation in terms of derived functors is given by the isomorphism

$$H^n(G, M) \cong \text{Ext}_{k[G]}^n(k, M).$$

The topological interpretation is given by the isomorphism

$$H^n(G, M) \cong H^n(BG, M).$$

For $n = 0$ one gets $H^0(G, M) = \text{Hom}^G(k, M) = M^G$ (submodule of G -invariant elements M). When $M = k$ is the trivial G -module, then $H^0(G) = k$ and $H^1(G, k) = \text{Hom}(G_{\text{ab}}, k)$.

C.7 Extensions and H^2 . For $n = 2$ there is a classical interpretation in terms of extensions as follows. Let G be a fixed group and A be a fixed G -module. Consider all the extensions of groups

$$(C.7.1) \quad 0 \rightarrow A \rightarrow E \rightarrow G \rightarrow 1$$

such that the G -module structure of the abelian group A induced by the extension is precisely the G -module structure we started with. Two such extensions are said to be *equivalent* if there exists an isomorphism of the middle groups over G which induces the identity on A . Denote by $\underline{\text{Ext}}(G, A)$ the set of equivalence classes of extensions. Then there is a canonical bijection

$$(C.7.2) \quad H^2(G, A) \cong \underline{\text{Ext}}(G, A).$$

C.8 Crossed Modules and H^3 . By definition a *crossed module* is a group homomorphism $\mu : M \rightarrow N$ together with an action (on the left) of N on M (denoted ${}^n m$ for $n \in N$ and $m \in M$) satisfying the following two conditions for all $n \in N$ and $m, m' \in M$:

- (a) $\mu({}^n m) = n\mu(m)n^{-1}$ (in other words μ is equivariant),
- (b) $\mu({}^m(m')) = mm'm^{-1}$.

Let $G = \text{Coker } \mu$ and $A = \text{Ker } \mu$. It is easy to check that A is abelian and that the action of N on M induces a well-defined G -module structure on A . A *morphism* from the crossed module $M \rightarrow N$ to the crossed module $M' \rightarrow N'$ is a commutative diagram

$$\begin{array}{ccc} M & \rightarrow & N \\ \alpha \downarrow & & \beta \downarrow \\ M' & \rightarrow & N' \end{array}$$

which is compatible with the actions ($\alpha({}^n m) = \beta({}^n \alpha(m))$).

Let us fix the group G and the G -module A . Consider all the crossed modules with cokernel G and kernel A (as G -modules). Two such crossed modules are said to be *related* if there exists a morphism from one to the other inducing the identity on the kernel and the identity on the cokernel. Denote by $\mathcal{X}\text{mod}(G, A)$ the set of equivalence classes of crossed modules with cokernel G and kernel A (as G -module) for the equivalence relation generated by the relation above. Then there is a canonical isomorphism

$$(C.8.1) \quad H^3(G, A) \cong \mathcal{X}\text{mod}(G, A).$$

The element in the H^3 group corresponding to the class of a crossed module under this isomorphism is called the *Mac Lane invariant* of the crossed module.

To any crossed module (M, μ, N) one can associate a simplicial group as follows. First, construct a category \mathcal{C} with $\text{Ob } \mathcal{C} = N$, $\text{Mor } \mathcal{C} = M \rtimes N$ (semi-direct product using the action of N on M). The source of the morphism (m, n) is n and its target is $\mu(m)n$. Composition is given by

$$\{n \xrightarrow{m} \mu(m)n \xrightarrow{m'} \mu(m')(\mu(m)n)\} = n \xrightarrow{m'm} \mu(m'm)n .$$

The nerve $B.C$ is such that $B_0C = N$, $B_1C = M \rtimes N$, $B_2C = M \rtimes (M \rtimes N)$, etc. One can check that $B.C$ is in fact a simplicial group. Its geometric realization BC is a topological group whose classifying space BBC is called the *classifying space of the crossed module*. One checks that BBC is a connected space with homotopy groups $\pi_1 = G$, $\pi_2 = A$ and $\pi_i = 0$ for $i > 2$. Moreover the action of π_1 on π_2 is precisely the G -module structure of A . Such a space is completely determined up to homotopy by its Postnikov invariant which lies in $H^3(B\pi_1, \pi_2) = H^3(BG, A) \cong H^3(G, A)$. It turns out that this Postnikov invariant corresponds exactly to the Mac Lane invariant of the crossed module.

C.9 Shapiro’s Lemma. *Let H be a subgroup of G and let M be a right H -module. Then the module*

$$\text{Ind}_H^G M := M \otimes_{k[H]} k[G]$$

is a right G -module called an *induced module*.

Shapiro’s lemma asserts that there is a functorial isomorphism

$$H_*(H, M) \cong H_*\left(G, \text{Ind}_H^G M\right) .$$

A similar assertion holds in the cohomological framework:

$$H^*(H, M) \cong H^*\left(G, \text{Coind}_H^G M\right) .$$

Here the *coinduced module* is by definition $\text{Coind}_H^G M := \text{Hom}_{k[H]}(k[G], M)$.

C.10 Homology of Small Categories (cf. Quillen [1973] and Baues-Wirsching [1985]). Let \mathcal{C} be a small category, that is a category whose class of objects form a set. Let $M : \mathcal{C} \rightarrow R\text{-Mod}$ and $N : \mathcal{C}^{op} \rightarrow \text{Mod-}R$ be two functors. Let $N \otimes_{\mathcal{C}, R} M$ be the abelian group defined by

$$N \otimes_{\mathcal{C}, R} M := \left(\bigoplus_{X \in \text{Ob}\mathcal{C}} N(X) \otimes_R M(X) \right) / U$$

where U is the subgroup generated by elements of the form

$$N(\alpha)x \otimes y - x \otimes M(\alpha)y,$$

where $\alpha : Y \rightarrow X$ is a morphism in \mathcal{C} , where $x \in N(X)$ and $y \in M(Y)$. Let $\text{Tor}_*^{\mathcal{C}, R}$ denote the left derived functors of $\otimes_{\mathcal{C}, R}$. When R is the ground ring, we simply write $\otimes_{\mathcal{C}}$ and $\text{Tor}_*^{\mathcal{C}}$. For any object $X \in \mathcal{C}$ we let h_X and h^X denote the functors:

$$\begin{aligned} h_X &:= R[\text{Hom}_{\mathcal{C}}(X, -)] : \mathcal{C} \rightarrow R\text{-Mod}, \\ h^X &:= R[\text{Hom}_{\mathcal{C}}(-, X)] : \mathcal{C}^{op} \rightarrow \text{Mod-}R. \end{aligned}$$

Remark that, the set of objects h_X (resp. h^X) form a set of small projective generators in the category of functors $(R\text{-Mod})^{\mathcal{C}}$ (resp. $(\text{Mod-}R)^{\mathcal{C}}$). Moreover one has isomorphisms

$$\begin{aligned} h^X \otimes_{\mathcal{C},R} M &\cong M(X), \\ N \otimes_{\mathcal{C},R} h^X &\cong N(X). \end{aligned}$$

Now we take R to be the ground ring k . By mimicking the Bousfield-Kan construction (cf. B.13) one gets a simplicial module $C(\mathcal{C}, M)$, whose module of n -chains is

$$C_n(\mathcal{C}, M) := \bigoplus_{X_0 \rightarrow \dots \rightarrow X_n} M(X_0),$$

where the sum is extended over all the n -simplices of the nerve of \mathcal{C} .

By definition the *colimit* of M is the module, denoted $\text{colim } M$, which is universal among the modules V equipped with natural maps $M(X_i) \rightarrow V$ for all $X_i \in \text{Ob } \mathcal{C}$. In other words, $\text{colim } M = \text{Tor}_0^{\mathcal{C}}(k, M)$. The left derived functors of the right exact functor colim are denoted $\text{colim}_i^{\mathcal{C}} := \text{Tor}_i^{\mathcal{C}}(k, -)$. The relationship with the above homology groups is given by a canonical isomorphism

$$H_*(\mathcal{C}, M) \cong \text{colim}_*^{\mathcal{C}} M.$$

If M is a *local coefficient system*, that is the image of any morphism in \mathcal{C} is an isomorphism of $k\text{-Mod}$, then the following topological interpretation holds,

$$H_*(\mathcal{C}, M) \cong H_*(BC, M),$$

where BC is the classifying space of the category.

However sometimes it is useful to work with the more general notion of *homology of a small category with coefficients in a bifunctor*. Let $D : \mathcal{C}^{op} \times \mathcal{C} \rightarrow k\text{-Mod}$ be a bifunctor. By mimicking the construction of the Hochschild complex one gets a simplicial module $C_*(\mathcal{C}, D)$ whose module of n -chains is

$$C_n(\mathcal{C}, D) := \bigoplus_{X_0 \rightarrow \dots \rightarrow X_n} D(X_n, X_0),$$

where the sum is extended over all the n -simplices of the nerve of \mathcal{C} . The analogue of Proposition 1.1.13 is the following isomorphism

$$H_*(\mathcal{C}, D) \cong \text{Tor}_*^{\mathcal{C}^{op} \times \mathcal{C}}(k[\mathcal{C}(-, -)], D).$$

In section 13.1 we need the following spectral sequence. For $M : \mathcal{C} \rightarrow R\text{-Mod}$ and $N : \mathcal{C}^{op} \rightarrow \text{Mod-}R$ functors, one defines the bifunctor

$$\text{Tor}_*^R(N, M) : \mathcal{C}^{op} \times \mathcal{C} \rightarrow Ab$$

by $(X, Y) \mapsto \text{Tor}_*^R(N(X), M(Y))$. Then one has a spectral sequence:

$$(C.10.1) \quad E_{pq}^2 = H_p(\mathcal{C}, \text{Tor}_q^R(N, M)) \implies \text{Tor}_{p+q}^{\mathcal{C}, R}(N, M)$$

which is a consequence of Grothendieck spectral sequence for composite of functors once one knows that $H_p(\mathcal{C}, N \otimes_R M) = 0$ for $p > 0$ and that N is projective. In order to show this last fact, it is enough to take $N = h^X$. One easily checks that $C_*(\mathcal{C}, N \otimes_R M) \cong C_*(\mathcal{C} \downarrow X, M)$, where $\mathcal{C} \downarrow X$ is the category of diagrams $? \rightarrow X$ in \mathcal{C} . Since this last category has a final object, its homology vanishes and we are done.

We leave to the reader the task of figuring out the cohomological version with \lim in place of colim , of which the next item is a particular case.

C.11 Inverse Systems. Let

$$M_0 \longleftarrow M_1 \longleftarrow \dots \longleftarrow M_n \xleftarrow{j} M_{n+1} \longleftarrow \dots$$

be an *inverse system* of k -modules indexed by the non-negative integers. The limit of $\{M_n\}$ is the module $\lim^0 \{M_n\} = \{(x_0, \dots, x_n, \dots) \in \prod_n M_n \mid j(x_n) = x_{n-1}\}$.

An inverse system can be interpreted as a functor M from the category $\mathcal{C} = \{0 \leftarrow 1 \leftarrow \dots \leftarrow n \leftarrow n+1 \leftarrow \dots\}$ to the category $(k\text{-Mod})$. Under this interpretation one has $\lim^0 \{M_n\} = H_{\mathcal{C}}^0 := \operatorname{Ext}_{\mathcal{C}}^0(k, M)$. Here is a useful criterion for the vanishing of \lim^1 , the first derived functor of \lim .

C.11.1 Mittag-Leffler Criterion. If for each $n \geq 0$ there exists an integer $\alpha(n) \geq n$ such that

$$\operatorname{Im}(M_r \rightarrow M_n) = \operatorname{Im}(M_{\alpha(n)} \rightarrow M_n) \text{ for all } r \geq \alpha(n),$$

then $\lim^1 \{M_n\} = 0$.

This criterion is useful in view of the long exact sequence relating the \lim^i -modules of an exact sequence of functors.

C.12 Shapiro’s Lemma for the Homology of Small Categories. Let $X : \mathcal{C} \rightarrow (\mathbf{Sets})$ be a (covariant) functor. Denote by $k[X]$ the associated functor with values in $(k\text{-Mod})$. Then, with the above notation, there is a canonical isomorphism

$$\operatorname{Tor}_{*}^{\mathcal{C}_X}(k, k) \cong \operatorname{Tor}_{*}^{\mathcal{C}}(k, k[X]),$$

where \mathcal{C}_X is the category with objects (C, x) , $C \in \operatorname{Ob}(\mathcal{C})$ and $x \in X(C)$. Here is a sketch of the proof. Let $p : \mathcal{C}_X \rightarrow \mathcal{C}$ be the forgetful functor, which induces $p^* : \operatorname{Func}(\mathcal{C}, k\text{-Mod}) \rightarrow \operatorname{Func}(\mathcal{C}_X, k\text{-Mod})$. Let $p_* : \operatorname{Func}(\mathcal{C}_X, k\text{-Mod}) \rightarrow \operatorname{Func}(\mathcal{C}, k\text{-Mod})$ be the left adjoint to p^* . This natural transformation p_* has adjoint on both sides, hence it is exact and preserves projectives. Therefore its derived functors are trivial and

$$\operatorname{Tor}_{*}^{\mathcal{C}_X}(k, k) \cong \operatorname{Tor}_{*}^{\mathcal{C}}(k, p_*(k)).$$

Since $p_*(k) = k[X]$, we are done. □

Exercise

EC. 1 Fox's Derivatives. Let $G = \{x_1, \dots, x_n \mid r_1, \dots, r_m\}$ be a group defined by generators and relations. The free differentials $\partial r_i / \partial x_j$ are elements of $\mathbb{Z}[G]$ defined by the rules

$$\frac{\partial(ab)}{\partial x} = \frac{\partial a}{\partial x} + a \frac{\partial b}{\partial x}, \quad \frac{\partial x}{\partial x} = 1, \quad \text{and} \quad \frac{\partial y}{\partial x} = 0$$

when y is a generator different from x . Show that the following sequence is the beginning of a free resolution,

$$\mathbb{Z}[G]^m \xrightarrow{\beta} \mathbb{Z}[G]^n \xrightarrow{\alpha} \mathbb{Z}[G] \xrightarrow{\varepsilon} \mathbb{Z},$$

where $\varepsilon(g) = 1$, $\alpha = [1 - x_1, \dots, 1 - x_n]$, $\beta =$ the $n \times m$ -matrix $\partial r_i / \partial x_j$. Apply this procedure to the quaternionic group. (Cf. Fox [1953].)

Appendix D. Spectral Sequences

Though spectral sequences have the reputation of being a difficult and technical subject it suffices to work out one particular example to understand how it works. The following is a brief overview of a spectral sequence deduced from a first quadrant bicomplex. Any textbook on homological algebra or algebraic topology contains a section or a chapter on spectral sequences including our favorites [CE] and [ML]. The very first account appeared in Koszul [1947].

D.1 Bicomplexes and Homology. Let us consider a bicomplex of modules (C_{pq}, d^h, d^v) in the first quadrant, that is $C_{pq} = 0$ if $p < 0$ or if $q < 0$, $d^h : C_{pq} \rightarrow C_{p-1,q}$, $d^v : C_{pq} \rightarrow C_{p,q-1}$, $d^h d^v + d^v d^h = d^h d^h = d^v d^v = 0$.

$$\begin{array}{ccccccc}
 & & \downarrow & & \downarrow & & \downarrow \\
 & & C_{02} & \leftarrow & C_{12} & \leftarrow & C_{22} & \leftarrow \\
 & & \downarrow & & \downarrow & & \downarrow & \\
 & & C_{01} & \leftarrow & C_{11} & \leftarrow & C_{21} & \leftarrow \\
 d^v \downarrow & & & & \downarrow & & \downarrow & \\
 & & C_{00} & \xleftarrow{d^h} & C_{10} & \leftarrow & C_{20} & \leftarrow
 \end{array}$$

Each individual column is a complex with homology $E_{pq}^1 = H_q(C_{p*}, d^v)$. From the commutation property of d^h and d^v , the horizontal differential induces a map $d^1 := (d^h)_* : E_{pq}^1 \rightarrow E_{p-1,q}^1$, which is still a differential. So, again, one can take the homology of these (horizontal) complexes to get

$$E_{pq}^2 := H_p(E_{*q}^1, d^1) = H_p^h H_q^v(C_{**}) .$$

D.2 The Map d^2 . Now there is a way of producing a map

$$d^2 : E_{pq}^2 \rightarrow E_{p-2,q+1}^2$$

as follows. Let $[x] \in E_{pq}^2$ be the class of the cycle $x \in E_{pq}^1$ (i.e. $d^1(x) = 0$). This element x is itself the class of some vertical cycle $\tilde{x} \in C_{pq}$ (i.e. $d^v(\tilde{x}) = 0$). The cycle condition $d^1(x) = (d^h)_*(x) = 0$ is equivalent to $d^h(\tilde{x}) = d^v(y)$ for some $y \in C_{p-1,q+1}$. From all these relations we get

$$d^v d^h(y) = -d^h d^v(y) = -d^h d^h(\tilde{x}) = 0 .$$

Therefore $d^h(y)$ is a vertical cycle in C_{p-2q+1} and determines a class $z = [d^h(y)] \in E_{p-2q+1}^1$,

$$\begin{array}{ccc} C_{p-2q+1} & \leftarrow & C_{p-1q+1} & & d^h y & \longleftarrow & y \\ & & \downarrow & & & & \downarrow \\ & & C_{p-1q} & \leftarrow & C_{pq} & & d^h(\tilde{x}) & \longleftarrow & \tilde{x} \end{array}$$

Let us compute $d^1(z)$,

$$d^1(z) = (d^h)_*(z) = [d^h d^h(y)] = 0 .$$

Therefore z is a cycle (for d^1) and determines an element $d^2[x] := [z] \in E_{p-2q+1}^2$. We leave to the reader the task of proving that the resulting map $d^2 : E_{pq}^2 \rightarrow E_{p-2q+1}^2$ is well-defined (independent of the choice of \tilde{x} for instance) and that it is a differential.

Note that in the notation d^2 the figure 2 is an index and d^2 does not mean $d \circ d$ here.

D.3 The Spectral Sequence. The first part of the theory of spectral sequences consists in proving that the construction of (E^2, d^2) can be pushed further to get an infinite sequence of modules E_{pq}^r and differentials $d^r : E_{pq}^r \rightarrow E_{p-rq+r-1}^r$ related to one another by the condition

$$E^{r+1} = H_*(E^r, d^r) .$$

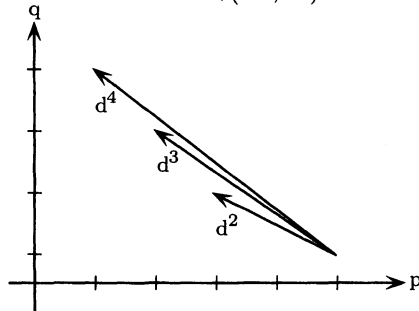

Note that if, for some fixed (p, q) , it ever happens that $E_{pq}^r = 0$ for some r , then $E_{pq}^{r'} = 0$ for any $r' \geq r$. In particular, since $C_{pq} = 0$ for $p < 0$ or $q < 0$, it follows that $E_{pq}^r = 0$ for $p < 0$ or $q < 0$, any r . As a consequence, for fixed (p, q) , the differentials ending at and starting from E_{pq}^r are 0 if r is large enough (say $r = r(p, q)$) and therefore

$$E_{pq}^r = E_{pq}^{r+1} = \dots = E_{pq}^\infty$$

for $r \geq r(p, q)$.

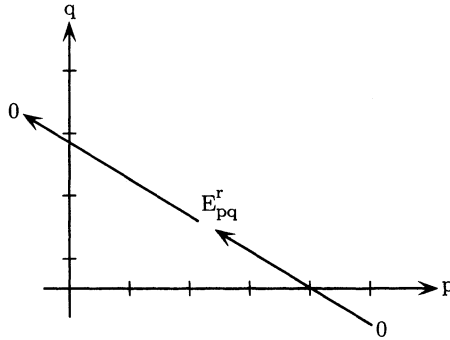

Let us now consider the homology of the total complex $\text{Tot } C_{**}$. There is a canonical increasing filtration on this complex obtained by taking the first columns:

$$(F_i \text{Tot } C_{**})_n = \bigoplus_{\substack{p+q=n \\ p \leq i}} C_{pq} .$$

This induces an increasing filtration (still denoted F_i) on $A_n = H_n(\text{Tot } C_{**})$,

$$0 \subset F_0 A_n \subset F_1 A_n \subset \dots \subset F_{n-1} A_n \subset F_n A_n = A_n .$$

D.4 Theorem. *The modules E_{pq}^∞ and the filtered module $A_n = H_n(\text{Tot } C_{**})$ are related by*

$$E_{pq}^\infty = F_p A_{p+q} / F_{p-1} A_{p+q} . \quad \square$$

In the literature this theorem is often written under the following form: there exists a *spectral sequence*

$$E_{pq}^2 = H_p^h(H_q^v(C_{**})) \Rightarrow A_{p+q} = H_{p+q}(\text{Tot } C_{**}) .$$

The symbol \Rightarrow is to be read “converges to”. Most of the time the filtration of the *abutment* A_n is not specified, but in many applications it is not needed (see for instance D.6 to D.8).

Note that one could take on $\text{Tot } C_{**}$ the filtration by columns. This would give a second spectral sequence of the form

$$E_{pq}'^2 = H_p^v(H_q^h(C_{**})) \Rightarrow A_{p+q} = H_{p+q}(\text{Tot } C_{**}) .$$

Though the abutment A_n is the same, the filtration is, in general, different.

D.5 Leray-Serre Spectral Sequence. There are more general data giving rise to spectral sequences. In particular, instead of starting with a bicomplex, one can start with a filtered complex. Hence one can define E^1, E^2 , etc and Theorem D.4 expresses the relation between the homology of the graded complex versus the graded module of the homology of the complex.

In particular let

$$F \rightarrow E \rightarrow B$$

be a fibration of connected CW -complexes. There is a filtration of the singular complex of E coming from the inverse image of the skeleton filtration of B . This gives rise to the so-called *Leray-Serre spectral sequence*:

$$E_{pq}^2 = H_p(B, H_q(F)) \Rightarrow H_{p+q}(E).$$

D.6 S^1 -Fibration and Gysin Sequence. In the particular case $F = S^1$ there are only two rows in the E^2 -plane which are not 0, the rows $q = 0$ and $q = 1$, since $H_q(S^1) = 0$ for $q \geq 2$. For both cases the E_{pq}^2 -group is isomorphic to $H_p(B)$. Hence the only non-trivial d^r -map is $d_{0q}^2 : H_q(B) \rightarrow H_{q-2}(B)$ and therefore the Leray-Serre spectral sequence degenerates into an exact sequence called the *Gysin sequence* of the S^1 -fibration

$$\dots \rightarrow H_q(E) \rightarrow H_q(B) \rightarrow H_{q-2}(B) \rightarrow H_{q-1}(E) \rightarrow \dots$$

One of the most useful applications of spectral sequences is the following theorem that we state in the case of filtered complexes for the sake of simplicity.

D.7 Theorem (Spectral Sequence Comparison Theorem, cf. Mac Lane [ML, p. 355]). *Let C_* and C'_* be two non-negatively filtered complexes and let $f : C_* \rightarrow C'_*$ be a map of filtered complexes. Then there is a canonical transformation of spectral sequences $f^r : E_{**}^r \rightarrow E'_{**}{}^r$. If f^r happens to be an isomorphism for some $r \geq 1$, then $f_* : H_*(C_*) \rightarrow H_*(C'_*)$ is an isomorphism. \square*

D.8 Theorem. *If in a first quadrant spectral sequence abutting on A_n the term E_{pq}^2 is 0 when $p > 0$ and $q > 0$, then there is a long exact sequence*

$$\dots \rightarrow E_{0n}^2 \rightarrow A_n \rightarrow E_{n0}^2 \xrightarrow{d^n} E_{0n-1}^2 \rightarrow \dots \quad \square$$

Appendix E. Smooth Algebras

by María O. Ronco¹

Our aim is to understand the relationship between the different definitions of “smooth” that appear in the literature.

We shall only deal with commutative rings, so from now on all rings and algebras are supposed to be commutative.

The main result of this part is Proposition E.2. Before stating it, let us give the following:

Definitions E.1.

- (i) An ideal $J \subset A$ is said to be a *locally complete intersection* if for every maximal ideal \mathfrak{m} of A , such that $J \subset \mathfrak{m}$, the ideal $J_{\mathfrak{m}} \subset A_{\mathfrak{m}}$ is generated by a $A_{\mathfrak{m}}$ -regular sequence. Since after localization a regular sequence either stays regular, or generates the unit ideal, it is clear that one obtains the same concept if in the definition the ideal \mathfrak{m} ranges over the prime ideals of A .
- (ii) A k -algebra A is said to be *unramified* if $\Omega_{A|k}^1 = 0$. If A is essentially of finite type over k (i.e. a localization of a finite type algebra), then this is equivalent to the following condition: for any maximal ideal \mathfrak{n} of A and its inverse image $\mathfrak{m} = \mathfrak{n} \cap k$ in k there is an equality $\mathfrak{m}A_{\mathfrak{n}} = \mathfrak{n}A_{\mathfrak{n}}$, and the induced extension of residue fields $A_{\mathfrak{n}}/\mathfrak{n}A_{\mathfrak{n}} \supset k_{\mathfrak{m}}/\mathfrak{m}k_{\mathfrak{m}}$ is finite separable. By the localization property of the module of Kähler differentials, one obtains the same concept if in the definition the ideal \mathfrak{n} ranges over all prime ideals of A .
- (iii) A finitely generated k -algebra A is said to be *étale* if it is flat and unramified.

Proposition E.2 and Definition. *Let k be a noetherian ring and A a commutative k -algebra which is essentially of finite type. If moreover $\mathrm{Tor}_n^k(A, A) = 0$ for $n > 0$ (e.g. A flat over k), then the following assertions are equivalent and A is said to be “smooth” over k :*

¹ I wish to thank Prof. Luchezar Avramov, who carefully read this Appendix, for his helpful corrections and comments.

(a) The kernel of the map

$$\mu : A \otimes_k A \rightarrow A$$

is a locally complete intersection.

(b) The canonical homomorphism $M \otimes_A \Omega_{A|k}^2 \rightarrow \text{Tor}_2^{A \otimes_k A}(A, M)$ is a surjection for any A -module M and $\Omega_{A|k}^1$ is a projective A -module.

(c) “Jacobian criterion”: let $P = k[X_1, \dots, X_n]_{\mathfrak{m}}$ be a polynomial algebra over k localized at some ideal \mathfrak{m} , and $\phi : P \rightarrow A$ a surjective k -algebra map. Let \mathfrak{p} be a prime ideal in A and \mathfrak{q} its inverse image in P . Then there exists $p_1, \dots, p_r \in P$ which generate $I_{\mathfrak{q}} = \text{Ker}(\phi)$ such that dp_1, \dots, dp_r are linearly independent in $\Omega_{P_{\mathfrak{q}}|k}^1 \otimes_{P_{\mathfrak{q}}} A_{\mathfrak{p}}$ (by linearly independent we understand that the image of the matrix $\left(\frac{\partial p_i}{\partial X_j}\right)$ in $A_{\mathfrak{p}}/\mathfrak{p}A_{\mathfrak{p}}$ has rank r).

(d) “Factorization via étale map”: for any prime ideal \mathfrak{p} of A there is an element $f \notin \mathfrak{p}$ such that there exists a factorization

$$k \hookrightarrow k[X_1, \dots, X_m] \xrightarrow{\phi} A_f$$

with ϕ étale.

(e) For any pair (C, I) , where C is a k -algebra and I an ideal of C such that $I^2 = 0$, the map $\text{Hom}_k(A, C) \rightarrow \text{Hom}_k(A, C/I)$ is surjective (here Hom_k means k -algebra homomorphisms).

In fact, we shall establish (under suitable conditions) the equivalence between each one of the assertions of Proposition E.2 and a vanishing criterion for André-Quillen (co)homology.

All these results are scattered through the literature, namely in S. Lichtenbaum and M. Schlessinger [L-S], M. André [A] and D. Quillen [Qu]. S. Lichtenbaum and M. Schlessinger worked with their homology and cohomology theory for commutative algebras, they defined $D_i(A|k, M)$ and $D^i(A|k, M)$ for $i = 0, 1, 2$, which are constructed in a quite different way of André-Quillen homology and cohomology groups (although they are isomorphic).

Let us begin by giving a scheme of our proof. First, we shall demonstrate the following:

Proposition E.3. *Let k be a noetherian ring and A a commutative k -algebra which is essentially of finite type, such that $\text{Tor}_n^k(A, A) = 0$ for $n > 0$ (e.g. A flat over k). Then the following statements are equivalent:*

- (1) $D^1(A|k, M) = 0$ for any A -module M ,
- (2) $D_1(A|k) = 0$ and $\Omega_{A|k}^1$ is projective over A ,
- (3) $D^2(A|A \otimes_k A, N) = 0$ for any A -module N ,
- (4) $D_2(A|A \otimes_k A) = 0$ and $\Omega_{A|k}^1$ is projective over A .

Then we shall show that the characterizations of smooth given in Proposition E.2 are related to the vanishing conditions for A-Q homology. Some of

the implications do not require the full noetherian hypothesis nor require the flatness hypothesis. So in each lemma we will indicate precisely the required hypothesis. The pattern of the proof of Proposition E.2 is the following: **(a)** $(\Rightarrow \mathbf{4}) (\Leftarrow \text{if } A \otimes_k A \text{ noetherian})$

\Downarrow H-K-R Theorem

(b) $\Rightarrow \mathbf{4}$

(c) $\Rightarrow \mathbf{2}$ (\Leftarrow if k noetherian and A essentially of finite type)

(d) $\Rightarrow \mathbf{2}$ (\Leftarrow if k noetherian and A essentially of finite type)

(e) $\Leftrightarrow \mathbf{1}$

Before entering the proof of Proposition E.3, let us recall the definition of André-Quillen homology:

If A is a k -algebra, L a free simplicial resolution of A and $A^\#$ the trivial simplicial algebra associated to A , then there exists a homomorphism of simplicial algebras $\Theta : L \otimes_k A \rightarrow A^\#$ which extends the multiplication map $\mu : A \otimes_k A \rightarrow A$ (namely, $\Theta_n = \mu \circ (d_0^n \otimes id_A)$). If we denote by I the kernel of Θ , then it is easy to check that there is an isomorphism of simplicial A -modules:

$$\Omega_{L|k}^1 \otimes_L A \cong I/I^2 .$$

Moreover, if M is a module over A , then $\Omega_{L|k}^1 \otimes_L M$ and $I/I^2 \otimes_A M$ are isomorphic.

Definition E.4. The *André-Quillen homology groups* $D_n(A|k, M)$ are the homology groups $H_n(I/I^2 \otimes_A M)$ for $n \geq 0$ (resp. the *A-Q cohomology groups* $D^n(A|k, M)$ are the cohomology groups $H^n(\text{Hom}_A(I/I^2, M))$).

Notation E.5. From now on, and until the end of this Appendix, we shall denote by B the tensor product $A \otimes_k A$. We shall consider A as a B -algebra with the structure given by μ , and B as an A -algebra with the structure given by $\iota : A \rightarrow A \otimes_k A$ which sends a to $a \otimes 1$. The algebra of polynomials in n variables over B will be denoted $B[n]$ instead of $B[X_1, \dots, X_n]$.

Proof of Proposition E.3: (1) \Rightarrow (2): The functors $D^i(A|k, -)$ are cohomological functors, therefore the vanishing of D^1 implies that $D^0(A|k, -) = \text{Hom}_A(\Omega_{A|k}^1, -)$ is an exact functor. This shows that $\Omega_{A|k}^1$ is projective.

Let $P \rightarrow A$ be a surjective k -algebra map with kernel J , where P is a polynomial algebra over k . Then an easy calculation gives us that $D_1(A|P, M) = J/J^2 \otimes_A M$ and $D^1(A|P, M) = \text{Hom}_A(J/J^2, M)$. Or, applying the Jacobi-Zariski exact sequence to $k \rightarrow P \rightarrow A$ we obtain that $D_1(A|k, M) = \text{Ker}(j)$ and $D^1(A|k, M) = \text{Coker}(\text{Hom}_A(j, M))$ where j is the homomorphism given by the following exact sequence:

$$(*) \quad 0 \rightarrow D_1(A|k) \rightarrow J/J^2 \xrightarrow{j} \Omega_{P|k}^1 \otimes_P A \rightarrow \Omega_{A|k}^1 \rightarrow 0 .$$

The resulting exact sequence gives an isomorphism $\text{Hom}_A(D_1(A|k), M) \cong \text{Coker}(\text{Hom}_A(j, M)) = D^1(A|k, M)$.

Let M be an injective A -module and apply the functor $\text{Hom}_A(-, M)$ to $(*)$. Then $D^1(A|k, M) = 0$ implies that $\text{Hom}_A(D^1(A|k), M) = 0$. Since one can choose M to contain $D_1(A|k)$, this shows that $D_1(A|k) = 0$.

(2) \Rightarrow (1). From the exact sequence $(*)$ we see that $D_1(A|k) = 0$ implies that $D^1(A|k, M) \cong \text{Ext}_A^1(\Omega_{A|k}^1, M)$, which is zero since $\Omega_{A|k}^1$ is projective.

(2) \Leftrightarrow (4). This equivalence requires the Tor-vanishing hypothesis. Consider the following sequence of ring maps: $A \xrightarrow{\iota} B \xrightarrow{\mu} A$. The Jacobi-Zariski exact sequence applied to this situation gives rise to the exact sequence:

$$\dots \rightarrow D_n(B|A, M) \rightarrow D_n(A|A, M) \rightarrow D_n(A|B, M) \rightarrow D_{n-1}(B|A, M) \rightarrow \dots,$$

for any A -module M .

Since $D_i(A|A) = 0$, the maps $D_n(A|B, M) \rightarrow D_{n-1}(B|A, M)$ are isomorphisms. By the flat base change property for AQ -homology one gets $D_i(B|A, A) \cong D_i(A|k)$ for $i \geq 0$. So finally $D_n(A|B) \cong D_{n-1}(A|k)$ and the vanishing of one of these two groups implies the vanishing of the other.

(1) \Leftrightarrow (3). Same arguments as for **(2) \Leftrightarrow (4)**. □

We can now start the proofs of the equivalences between the conditions of Propositions E.2 and E.3.

The main tools to study the relations between conditions **a)**, **b)** and **4)** are the Koszul complex $K(\underline{x})$ associated to a sequence $\underline{x} = (x_1, \dots, x_n)$ (cf. Sect. 3.4) and the following theorem of D. Quillen, called the *fundamental spectral sequence* for André-Quillen homology:

Theorem E.6. *With the same notation of Definition E.4, if A is a quotient of k , then there is a spectral sequence:*

$$E_{pq}^2 : H_{p+q}[S_A^q(I/I^2)] \Rightarrow \text{Tor}_{p+q}^k(A, A),$$

where $S_A(I/I^2)$ denotes the simplicial algebra over A whose n -term is the symmetric algebra $S_A((I/I^2)_n)$ over the A -module $(I/I^2)_n$.

Proof. Cf. [Qu]

6 or [A] Chap. XX.Prop. 24 and Chap. XIII for the convergence of the spectral sequence. □

Corollary E.7. *If A is a quotient of k , then there is a five term exact sequence:*

$$\text{Tor}_3^k(A, A) \rightarrow D_3(A|k) \rightarrow \mathbf{\Lambda}_A^2 D_1(A|k) \rightarrow \text{Tor}_2^k(A, A) \rightarrow D_2(A|k) \rightarrow 0.$$

Proof. It is a consequence of the theorem, because

$$H_n[S_A^2(I/I^2)] \cong \Lambda_A^2[H_n(I/I^2)]. \quad \square$$

We enter now in the proof of the relations between vanishing conditions of Proposition E.3 and the different definitions of smoothness.

Lemma E.8: (a) \Rightarrow 4). *If $J = \text{Ker}(B = A \otimes_k A \xrightarrow{\mu} A)$ is a locally complete intersection, then $D_n(A|B, N) = 0$, for $n \geq 2$ and $\Omega_{A|k}^1$ is a projective A -module.*

Proof. It suffices to prove that $D_n(A|B, N)_{\mathfrak{m}} = 0$ for any maximal ideal \mathfrak{m} of A , so by the localization property of André-Quillen homology one can assume that A and B are local and that J is generated by a regular sequence $x = (x_1, \dots, x_n)$. Let us consider now B with two different structures of $B[n]$ -algebra:

- we shall denote by B the $B[n]$ -algebra structure given by: $B[n] \xrightarrow{e(x)} B$ which sends $P(X_1, \dots, X_n)$ to $P(x_1, \dots, x_n)$.
- we shall denote by \tilde{B} the $B[n]$ -algebra structure given by the projection $B[n] \xrightarrow{p} B$ which sends $P(X_1, \dots, X_n)$ to $P(0, \dots, 0)$.

Then we have $A = \tilde{B} \otimes_{B[n]} B$. The long Jacobi-Zariski exact sequence applied to

$$B \xrightarrow{\iota} B[n] \xrightarrow{p} \tilde{B}$$

gives us that

$$D_m(\tilde{B}|B[n], N) = 0 \quad \text{for } m > 1 \quad \text{and any } \tilde{B}\text{-module } N.$$

By the flat base change property (cf. 3.5.5.2) it suffices to prove that $\text{Tor}_m^{B[n]}(\tilde{B}, B) = 0$ for $m \neq 0$, because in this case

$$D_m(A|B, N) \cong D_m(\tilde{B}|B[n], N) \quad \text{for } m > 1$$

and any A -module N . But this result follows from the fact that $\mathcal{X} = (X_1, \dots, X_n)$ is a regular sequence in $B[n]$ and then:

$$\text{Tor}_m^{B[n]}(\tilde{B}, B) = H_n(K(\mathcal{X}) \otimes_{B[n]} B),$$

where $K(\mathcal{X})$ is the Koszul resolution of \tilde{B} . As $K(\mathcal{X}) \otimes_{B[n]} B \cong K(\underline{x})$ and (\underline{x}) is regular, by Lemma 3.4.8, $H_n(K(\underline{x})) = 0$ for $n > 0$.

As \underline{x} is regular, then $\Omega_{A|k}^1$ is locally free, generated by the classes of x_1, \dots, x_n . So the projectivity of $\Omega_{A|k}^1$ becomes evident. \square

We have proved that condition (a) implies $D_2(A|B, N) = 0$ for any A -module N and $D_1(A|B) \cong \Omega_{A|k}^1$ is a projective A -module. We are now going to look at the converse implication.

Lemma E.9: (a) \Leftarrow 4). *Let B be a noetherian ring, then the conditions $D_2(A|B) = 0$ and $\Omega_{A|k}^1$ is a projective finite A -module imply that J is a locally complete intersection.*

Proof. We can assume that A and B are local rings. Using the same notation as in Lemma E.8, since A is a local ring $\Omega_{A|k}^1 \cong J/J^2$ is a free A -module. Denote by $\underline{x} = (x_1, \dots, x_n)$ a set of elements of J whose classes form a basis of J/J^2 , by Nakayama's lemma the x_i 's generate J . We have that $\text{Tor}_m^{B[n]}(\tilde{B}, B) = H_m(K(\underline{x}))$ for $m \geq 0$. By Corollary E.7 and the fact that $D_2(A|B) = 0$, the following morphism is an epimorphism:

$$\Lambda_A^2 D_1(A|B) \rightarrow \text{Tor}_2^B(A, A).$$

But there is a well-known exact sequence for the functor Tor :

$$\begin{aligned} (**) \quad \text{Tor}_2^{B[n]}(\tilde{B}, A) &\rightarrow \text{Tor}_2^B(A, A) \rightarrow \text{Tor}_1^{B[n]}(\tilde{B}, B) \otimes_B A \\ &\rightarrow \text{Tor}_1^{B[n]}(\tilde{B}, A) \rightarrow \text{Tor}_1^B(A, A) \rightarrow 0. \end{aligned}$$

As $\text{Tor}_n^{B[n]}(\tilde{B}, A) = H_n(K(\mathcal{X}) \otimes_{B[n]} A)$, then it suffices to note that $K(\mathcal{X}) \otimes_{B[n]} A$ is the complex:

$$\dots \xrightarrow{0} \Lambda_A^m A^n \xrightarrow{0} \dots \xrightarrow{0} \Lambda_A^2 A^n \xrightarrow{0} A^n \xrightarrow{0} A.$$

So, since $A^n \cong J/J^2$ as A -module, $\text{Tor}_n^{B[n]}(\tilde{B}, A) \cong \Lambda_A^n(J/J^2)$. Applying this result to (**), we have:

- $\text{Tor}_2^{B[n]}(\tilde{B}, A) \rightarrow \text{Tor}_2^B(A, A)$ is an epimorphism,
- $\text{Tor}_1^{B[n]}(\tilde{B}, A) \rightarrow \text{Tor}_1^B(A, A)$ is an isomorphism, and
- $\text{Tor}_1^{B[n]}(\tilde{B}, B) \otimes_B A = 0$, then by Nakayama's lemma

$$\text{Tor}_1^{B[n]}(\tilde{B}, B) \cong H_1(K(\underline{x})) = 0.$$

Now, as B is a noetherian ring, $H_1(K(\underline{x})) = 0$ implies \underline{x} is a regular sequence (cf. [Ma]). □

Lemma E.10:

- (i) *If B is a noetherian ring, then the conditions $D_2(A|B) = 0$ and $\Omega_{A|k}^1$ is a projective A -module imply $D_n(A|B, N) = 0$ for any A -module N and $n \geq 2$.*
- (ii) **(b) \Rightarrow 4)** *The fact that $\Omega_{A|k}^2 \rightarrow \text{Tor}_2^{A \otimes_k A}(A, A)$ is a surjection implies that $D_2(A|B)$ is zero. And if B is a noetherian ring, then the conditions $\Omega_{A|k}^2 \rightarrow \text{Tor}_2^{A \otimes_k A}(A, A)$ is a surjection and $\Omega_{A|k}^1$ a projective A -module imply that $J = \text{Ker}(B \xrightarrow{\mu} A)$ is a locally complete intersection.*

Proof. Assertion (i) is a straightforward consequence of Lemmas E.8 and E.9.

If $\Omega_{A|k}^2 \rightarrow \text{Tor}_2^{A \otimes_k A}(A, A)$ is a surjection, by Corollary E.7 we have that $D_2(A|B)$ is zero because $D_1(A|B) \cong \Omega_{A|k}^1$. In the case where B is noetherian and $\Omega_{A|k}^1$ is a projective A -module, we can apply Lemma E.9 to finish the proof of assertion (ii). \square

Note that the converse is true if A is flat over k by the Hochschild-Kostant-Rosenberg theorem (cf. 3.4.4).

We shall now look at the assertion e) (“lifting property”) of Proposition E.2; the following lemma states that it is equivalent to a vanishing condition of A-Q cohomology.

Lemma E.11: (e) \Leftrightarrow 1)). $D^1(A|k, M) = 0$ for any A -module M if and only if A and k verify condition e) of Proposition E.2.

Proof. Let us suppose that A verifies condition e) of Proposition E.2. If P is a free k -algebra such that A is a quotient of P , the following Jacobi-Zariski sequence is exact:

$$0 \rightarrow \text{Hom}_A(\Omega_{A|k}^1, M) \rightarrow \text{Hom}_P(\Omega_{P|k}^1, M) \xrightarrow{\tau} D^1(A|P, M) \rightarrow D^1(A|k, M) \rightarrow 0.$$

If $I = \text{Ker}(P \xrightarrow{p} A)$, then $D^1(A|P, M) = \text{Hom}_A(I/I^2, M)$. Clearly it suffices to prove that τ is an epimorphism. Consider the exact sequence:

$$0 \rightarrow I/I^2 \rightarrow P/I^2 \xrightarrow{q} A \rightarrow 0.$$

As A verifies e), it exists $\iota : A \rightarrow P/I^2$ such that $q \circ \iota = \text{id}_A$. If $f \in \text{Hom}_A(I/I^2, M)$, let us define $\tilde{f} \in \text{Hom}_P(\Omega_{P|k}^1, M)$ by

$$\tilde{f}(adx) = af(\bar{x} - \iota \circ q(\bar{x}))$$

where \bar{x} is the class of x in P/I^2 . It is easy to check that $\tau(\tilde{f}) = f$.

Conversely, if $D^1(A|k, M) = 0$, suppose that we have a morphism of k -algebras $f : A \rightarrow C/N$, where C is a k -algebra and N an ideal of C such that $N^2 = 0$. As P is a free k -algebra it exists a morphism of k -algebras $\bar{f} : P \rightarrow C$ such that $f \circ p = \pi \circ \bar{f}$ (where π is the projection from C to C/N). So $\bar{f}(x) \in N$ if $x \in I$. The map \bar{f} induces then a morphism $\bar{f}' : I/I^2 \rightarrow N$ of A -modules.

As $\text{Hom}_P(\Omega_{P|k}^1, N) \xrightarrow{\tau} D^1(A|P, N)$ is an epimorphism, we may find $h \in \text{Hom}_P(\Omega_{P|k}^1, N)$ such that $\tau(h) = \bar{f}'$. For any $a \in A$ let $x \in L$ be a lifting of a , that is $p(x) = a$. Then, define \tilde{f} by $\tilde{f}(a) = \bar{f}(x) - h(dx)$. Verifying that $\tilde{f} \circ \pi = f$ is trivial. \square

Our final task is to establish the relation between assertions (c) and (d) of Proposition E.2 and the vanishing condition for $D_1(A|k)$.

Lemma E.12.

- (i) If $B_{\mu^{-1}(\mathfrak{m})} = (A \otimes_k A)_{\mu^{-1}(\mathfrak{m})} \rightarrow A_{\mathfrak{m}}$ is an isomorphism for any maximal ideal \mathfrak{m} of A then $D_0(A|k, N) = 0$ for any A -module N .
- (ii) If $A \otimes_k A$ is a noetherian ring and $D_0(A|k) = 0$, then $B_{\mu^{-1}(\mathfrak{m})} = (A \otimes_k A)_{\mu^{-1}(\mathfrak{m})} \rightarrow A_{\mathfrak{m}}$ is an isomorphism for any maximal ideal \mathfrak{m} of A .
- (iii) If A is étale over k , then $D_n(A|k, N) = 0$ for any A -module N and $n \geq 0$.

Proof.

- (i) As $B_{\mu^{-1}(\mathfrak{m})} \rightarrow A_{\mathfrak{m}}$ is an isomorphism, then

$$D_0(A_{\mathfrak{m}}|k, N_{\mathfrak{m}}) = \Omega_{A_{\mathfrak{m}}|k}^1 \otimes_{A_{\mathfrak{m}}} N_{\mathfrak{m}} = 0$$

for any maximal ideal \mathfrak{m} of A , which implies $D_0(A|k, N) = 0$.

- (ii) Let \mathfrak{m} be a maximal ideal of A and denote by J the kernel of

$$(A \otimes_k A)_{\mu^{-1}(\mathfrak{m})} \rightarrow A_{\mathfrak{m}} .$$

Clearly $D_0(A|k) = 0$ implies $J/J^2 = 0$ and so by Nakayama's lemma $J = 0$.

- (iii) By (ii) $B_{\mu^{-1}(\mathfrak{m})} \rightarrow A_{\mathfrak{m}}$ is an isomorphism for any maximal ideal \mathfrak{m} of A . As A is flat over k , using the Jacobi-Zariski exact sequence for $A \rightarrow B \xrightarrow{\mu} A$ and the flat base change property of A-Q homology, $D_n(A|k, N) = D_{n+1}(A|B, N)$ for $n \geq 0$. Now, by the localization property, $[D_n(A|B, N)]_{\mathfrak{m}}$ is isomorphic to $D_n(A_{\mathfrak{m}}|B_{\mu^{-1}(\mathfrak{m})}, N_{\mathfrak{m}})$ which is zero for any maximal ideal \mathfrak{m} of A . Then $D_n(A|k, N) = 0$, for $n \geq 0$. □

Remark E.13. In Lemmas E.14 and E.15 we are going to make statements for essentially of finite type algebras but, with the purpose of making notation easier, we are going to give the proof for algebras of finite type. In fact it suffices to note that in all cases we may replace the polynomial rings by their localizations and, as A-Q homology is stable by localization, the proofs continue to be valid.

Lemma E.14. *If k is a noetherian ring and A is a k -algebra essentially of finite type such that $D_1(A|k) = 0$ and $\Omega_{A|k}^1$ is a projective A -module, then A is flat over k .*

Proof. (Cf. [K],

8.1 and [Ma] Chap. 11).

Let $P = k[X_1, \dots, X_n]$ be such that it exists a surjective k -algebra map $\phi : P \rightarrow A$. Let \mathfrak{p} be a prime ideal in A , \mathfrak{q} its inverse image in P and \mathfrak{i} its inverse image in k . Then it exists a Jacobi-Zariski exact sequence:

$$0 \rightarrow I_{\mathfrak{q}}/I_{\mathfrak{q}}^2 \rightarrow \Omega_{P_{\mathfrak{q}}|k}^1 \otimes_{P_{\mathfrak{q}}} A_{\mathfrak{p}} \rightarrow \Omega_{A_{\mathfrak{p}}|k}^1 \rightarrow 0 .$$

As $\Omega_{A_p|k}^1$ is free as A_p -module, then I_q/I_q^2 is also a free module over A_p . Denote by $\underline{p} = (p_1, \dots, p_r)$ a set of elements of I_q whose classes form a basis of I_q/I_q^2 , by Nakayama's lemma the p_i 's generate I_q and dp_1, \dots, dp_r are linearly independent in $\Omega_{P_q|k}^1 \otimes_{P_q} A_p$.

If we look now at the residual field \mathfrak{k} of k_i , then A_p/iA_p and P_q/iP_q are \mathfrak{k} -modules. Let us denote A_p/iA_p by \mathcal{A}_p , P_q/iP_q by \mathcal{P}_q , J the image of I_q in \mathcal{P}_q and \mathfrak{K} the common residue field of \mathcal{P}_q and \mathcal{A}_p . The Krull dimension of \mathcal{A}_p is $m - ht(J\mathcal{P}_q)$, where m is the Krull dimension of \mathcal{P}_q . We know that \mathcal{P}_q is a regular local ring and we want to show that \mathcal{A}_p is regular, i.e. that $J\mathcal{P}_q$ is a prime ideal generated by a subset of a regular system of parameters of \mathcal{P}_q . But it is equivalent to show that the rank of the image of ν is equal to $ht(J\mathcal{P}_q)$, where ν is the natural map from $J/J^2 \otimes_{\mathfrak{k}[X_1, \dots, X_n]} \mathfrak{K}$ into $\tilde{q}/\tilde{q}^2 \otimes_{\mathfrak{k}[X_1, \dots, X_n]} \mathfrak{K}$ and \tilde{q} is the image of q in \mathcal{P}_q (the rank of the image of ν is always $\leq ht(J\mathcal{P}_q)$ cf. [Ma], Chap. 11.29).

We have now that the following sequence is exact (cf. [Ma], Chap. 10, Theorem 58)

$$\tilde{q}/\tilde{q}^2 \otimes_{\mathcal{P}_q} \mathfrak{K} \xrightarrow{\delta} \Omega_{\mathcal{P}_q|\mathfrak{k}}^1 \otimes_{\mathcal{P}_q} \mathfrak{K} \rightarrow \Omega_{\mathfrak{K}|\mathfrak{k}}^1 \rightarrow 0.$$

So if we look at the composition $\delta \circ \nu$, we find that its image is generated by the images of dp_1, \dots, dp_r in $\Omega_{\mathcal{P}_q|\mathfrak{k}}^1 \otimes_{\mathcal{P}_q} \mathfrak{K}$, which implies that the rank of the image of ν is greater than $r = ht(J\mathcal{P}_q)$.

Using the local criterion of [Ma] Chap. 8, 20.F, as J is generated by a \mathcal{P}_q -regular sequence and $\mathcal{P}_q/J\mathcal{P}_q \cong \mathcal{A}_p$ is flat over \mathfrak{k} (in fact \mathfrak{k} is a field) we may assert that \mathcal{A}_p is a flat k -module. Then A_p is flat over k for any prime ideal \mathfrak{p} of A , which implies that A is flat over k . □

Lemma E.15.

- (i) (c) \Rightarrow 2)) Condition c) ("Jacobian criterion") of Proposition E.2 implies $D_1(A|k) = 0$ and $\Omega_{A|k}^1$ is a projective A -module.
- (ii) (c) \Leftarrow 2)) If A is a k -algebra essentially of finite type and k is a noetherian ring then the converse of (i) is true.
- (iii) (d) \Rightarrow 2)) Condition (d) ("Factorization via étale map") of Proposition E.2 implies $D_1(A|k) = 0$ and $\Omega_{A|k}^1$ is a projective A -module.
- (iv) (d) \Leftarrow 2)) If A is a k -algebra of finite type and k is a noetherian ring then the converse of (iii) is true.

Proof.

(i) If P is a polynomial algebra over k and $\phi : P \rightarrow A$ a surjective k -algebra map, then we have the same exact sequence of Proposition E.3:

$$(*) \quad 0 \rightarrow D_1(A|k) \rightarrow D_1(A|P) \rightarrow \Omega_{P|k}^1 \otimes_P A \rightarrow \Omega_{A|k}^1 \rightarrow 0.$$

If we localize, as $D_1(A_p|P_q) \cong I_q/I_q^2$ (with $I_q = \text{Ker}(P_q \rightarrow A_p)$) and dp_1, \dots, dp_r are linearly independent in $\Omega_{P_q|k}^1 \otimes_{P_q} A_p$, the morphism

$D_1(A_{\mathfrak{p}}|P_{\mathfrak{q}}) \rightarrow \Omega_{P_{\mathfrak{q}}|k}^1 \otimes_{P_{\mathfrak{q}}} A_{\mathfrak{p}}$ is a monomorphism, which implies that $D_1(A_{\mathfrak{p}}|k) = 0$. By the localization property for A-Q homology we deduce $D_1(A|k) = 0$. As $\Omega_{A_{\mathfrak{p}}|k}^1$ is the cokernel of $D_1(A_{\mathfrak{p}}|P_{\mathfrak{q}}) \rightarrow \Omega_{P_{\mathfrak{q}}|k}^1 \otimes_{P_{\mathfrak{q}}} A_{\mathfrak{p}}$ then it is free, consequently $\Omega_{A|k}^1$ is projective.

(ii) Conversely, we know that there exists a localization of a polynomial algebra P over k such that there is an epimorphism of k -algebras $\phi : P \rightarrow A$.

Applying Jacobi-Zariski, we have (*) and, localizing at \mathfrak{p} , as $D_1(A_{\mathfrak{p}}|k) = 0$, the homomorphism $D_1(A_{\mathfrak{p}}|P_{\mathfrak{q}}) \rightarrow \Omega_{P_{\mathfrak{q}}|k}^1 \otimes_{P_{\mathfrak{q}}} A_{\mathfrak{p}}$ is a monomorphism. As $\Omega_{A_{\mathfrak{p}}|k}^1$ is a free $A_{\mathfrak{p}}$ -module, $D_1(A_{\mathfrak{p}}|P_{\mathfrak{q}})$ is a free module over $A_{\mathfrak{p}}$ too. We can choose then a system of generators p_1, \dots, p_r of $I_{\mathfrak{q}}$ such that dp_1, \dots, dp_r are linearly independent in $\Omega_{P_{\mathfrak{q}}|k}^1 \otimes_{P_{\mathfrak{q}}} A_{\mathfrak{p}}$.

(iii) Suppose that for any prime ideal \mathfrak{p} of A there is an element $f \notin \mathfrak{p}$ such that there exists a factorization

$$k \hookrightarrow k[X_1, \dots, X_m] \xrightarrow{\phi} A_f$$

with ϕ étale. Then by Jacobi-Zariski there is an exact sequence:

$$0 \rightarrow D_1(A_f|k) \rightarrow D_1(A_f|P) \rightarrow \Omega_{P|k}^1 \otimes_P A_f \rightarrow \Omega_{A_f|k}^1 \rightarrow D_0(A_f|P) \rightarrow 0.$$

and by Lemma E.12. (iii), $D_1(A_f|P) = D_0(A_f|P) = 0$. As a consequence we get $D_1(A|k) \cong D_1(A_f|k) = 0$. Now $\Omega_{A_f|k}^1 \cong \Omega_{P|k}^1 \otimes_P A_f$ is free over A_f so $\Omega_{A_{\mathfrak{p}}|k}^1$ is free over $A_{\mathfrak{p}}$ for each prime ideal \mathfrak{p} and $\Omega_{A|k}^1$ is projective over A .

(iv) Suppose now that $D_1(A|k) = 0$ and $\Omega_{A|k}^1$ is projective over A and let $P = k[X_1, \dots, X_n]_m$ be such that $A = P/I$. If \mathfrak{p} is a prime ideal of A and \mathfrak{k} is the residual field of $A_{\mathfrak{p}}$, the Jacobi-Zariski exact sequence induces an exact sequence:

$$0 \rightarrow I_{\mathfrak{q}}/I_{\mathfrak{q}}^2 \rightarrow \Omega_{P_{\mathfrak{q}}|k}^1 \otimes_{P_{\mathfrak{q}}} A_{\mathfrak{p}} \rightarrow \Omega_{A_{\mathfrak{p}}|k}^1 \rightarrow 0.$$

As $\Omega_{A_{\mathfrak{p}}|k}^1$ is a free $A_{\mathfrak{p}}$ -module we may choose $p_1, \dots, p_r \in P_{\mathfrak{q}}$ which generate $I_{\mathfrak{q}}$ such that dp_1, \dots, dp_{r+1} are linearly independent in $\Omega_{P_{\mathfrak{q}}|k}^1 \otimes_{P_{\mathfrak{q}}} A_{\mathfrak{p}}$. Upon tensoring with \mathfrak{k} we complete to a basis of $\Omega_{P_{\mathfrak{q}}|k}^1 \otimes_{P_{\mathfrak{q}}} \mathfrak{k}$ with the elements dp_{r+1}, \dots, dp_n such that dp_{r+1}, \dots, dp_n is a system of generators of $\Omega_{A_{\mathfrak{p}}|k}^1$. Let us consider now $\phi : k[X_1, \dots, X_{n-r}] \rightarrow A_{\mathfrak{p}}$ such that $\phi(X_i) = p_{r+i}$ ($i = 1, \dots, n-r$). From the corresponding Jacobi-Zariski exact sequence, it is easy to see that:

$$D_1(A_{\mathfrak{p}}|k[X_1, \dots, X_{n-r}]) = D_0(A_{\mathfrak{p}}|k[X_1, \dots, X_{n-r}]) = 0$$

then, $A_{\mathfrak{p}}$ is étale over $k[X_1, \dots, X_{n-r}]$ and so it exists $f \notin \mathfrak{p}$ and that verifies 2) (cf. [SGA 1], Exposé 1, Proposition 4.5). □

So we have established that any statement of Proposition E.2 is equivalent to a statement of Proposition E.3. Since the second ones are equivalent, this ends the proof of Proposition E.2. □

References of Appendix E

- [A] M. André, *Homologie des algèbres commutatives*, Springer Verlag, 1974.
- [K] E. Kuntz, *Kähler Differentials*, Viehweg Advanced Lectures in Mathematics (1986).
- [L-S] S. Lichtenbaum and M. Schlessinger, *The cotangent complex of a morphism*, *Trans. A.M.S.* 128, 41–70 (1967).
- [Ma] H. Matsumura, *Commutative Algebra*, (2nd ed.) Benjamin, Reading Mass. (1980).
- [Qu] D. Quillen, *On the (co)-homology of commutative rings*, *Proc. Symp. Pure Math.* 17 (1970) 65–87.
- [R] M. Raynaud, *Anneaux Locaux Henséliens*, *Lect. Notes in Math.* No. 169, Springer Verlag (1970).
- [SGA 1] A. Grothendieck, *Séminaire de Géométrie Algébrique, 1960–61*, *Lect. Notes in Math.* No. 224, Springer-Verlag, Berlin, 1971.

References

In the text, the references are given by the name(s) of the author(s) followed by a year [2000]. If there are several articles of the same author(s) in a given year, then the first one in the list is referred to as [2000a], the second one as [2000b], and so on. There are five exceptions which are the following references,

- [C] = Connes [1985],
- [CE] = Cartan-Eilenberg [1956],
- [FT] = Feigin-Tsygan [1987a],
- [LQ] = Loday-Quillen [1984],
- [ML] = Mac Lane [1963].

The following list contains the books and research articles about the cyclic theory published before 1.1.1992. Besides the fact that, in general, the announcements were skipped when the full paper is available, I hope that this list is reasonably complete. When available, the Maths Reviews reference is mentioned. For Papers not yet published the reference in the text is [1992].

- ABOUGHAZI, R., Homologie restreinte des p -algèbres de Lie en degré deux, *Ann. Inst. Fourier* 39 (1989), 641–649. 90m:17026
- ADEM, A., COHEN, R.L., DWYER, W.G., Generalized Tate homology, homotopy fixed points and the transfer, *Contemp. Math.* 96 (1989), 1–13. 90k:55012
- ANDRÉ, M., Homologie des algèbres commutatives, *Grund. Math. Wissen.* 206. Springer, 1974.
- ARAKI, H., Schwinger terms and cyclic cohomology, *Math. Phys. St.* 10, Kluwer (1988), 1–22. 90c:46084
- ATIYAH, M.F., BOTT, R., PATODI, V.K., On the heat equation and the index theorem, *Invent. Math.* 19 (1973), 279–330.
- ATIYAH, M.F., TALL, D.O., Group representations, λ -rings and the J-homomorphism, *Topology* 8 (1969), 253–297.
- AVRAMOV, L., HALPERIN, S., On the vanishing of cotangent cohomology, *Comment. Math. Helv.* 62 (1987), 169–184.
- BUENOS AIRES CYCLIC HOMOLOGY GROUP (J.A. GUCCIONE, J.J. GUCCIONE, M.J. REDONDO, A. SOLOTAR and O.E. VILLAMAYOR), Cyclic homology of algebras with one generator *K-Theory* 5 (1991), 51–69.
- BARR, M., Harrison homology, Hochschild homology and triples, *J. Alg.* 8 (1968), 314–323.
- BAUES, H.-J., WIRSCHING, G., The cohomology of small categories, *J. Pure Appl. Algebra* 38 (1985), 187–211.

- BASS, H., Algebraic K-theory, Benjamin, 1968.
- BAUM, P., CONNES, A., Chern character for discrete groups, in *Fête of topology*, Academic Press (1988), 163–232. 90e:58149
- BAUM, P., CONNES, A., K-theory for discrete groups, London Math. Lect. Ser. 135. *Operators Alg. and Appl. 1* (1988), 1–20. 91i:46083
- BEILINSON, A.A., Current problems in mathematics, vol. 24 (1984), 181–238. 86h:11103
- BEILINSON, A.A., Higher regulators and values of L-functions, *J. Soviet. Math.* 30 (1985), 2036–2070.
- BELLISSARD, J., Ordinary quantum Hall effect and non-commutative cohomology, *Teubner Text Phys.* (1986), 61–74. 91c:82005
- BENNIS, C., Homologie de l'algèbre de Lie $sl_2(A)$, *C. R. Acad. Sci. Paris Sér. A-B* 310 (1990), 339–341. 90f:18010
- BERSON, D., Cyclic homology and path algebra resolutions, *Math. Proc. Camb. Phil. Soc.* 106 (1989), 57–66. 90f:18010
- BENTZEN, S., MADSEN, I., Trace maps in algebraic K-theory and the Coates-Wiles homomorphism, *J. Reine Ang. Math.* 411 (1990), 171–195. 91i:19002.
- BLANC, P., BRYLINSKI, J.-L., Cyclic homology and the Selberg principle, *J. Funct. Analysis* 109 (1992), 289–330.
- BLOCH, S., The dilogarithm and extensions of Lie algebras, Alg. K-theory, Evanston 1980, *Springer Lect. Notes in Math.* 854 (1981), 1–23. 83b:17010
- BLOCK, J.L., Cyclic homology of filtered algebras, *K-theory 1* (1987), 515–518. 89b:18018
- BÖKSTEDT, M., HSIANG, W.-C., MADSEN, I., The cyclotomic trace and algebraic K-theory of spaces, *Inv. Math.* 111 (1993), 465–540.
- BOREL, A., Stable real cohomology of arithmetic groups, *Ann. Sc. Ec. Norm. Sup.* 7 (1974), 235–272.
- BOURBAKI, N., Algèbre homologique, Algèbre chap. X, Masson, 1980.
- BOUSFIELD, A.K., KAN, D.M., Homotopy limits, completions and localizations, *Springer Lect. Notes in Math.* 304, 1972.
- BRENKEN, B., CUNTZ, J., ELLIOTT, G.A., NEST, R., On the classification of non-commutative tori III, *Contemp. Math.* 62 (1987), 503–526. 88k:46072
- BRODZKI, J., Lie cochains on an algebra, in *The interface of math and particle phys.*, Oxford Univ. Press (1990), 223–227.
- BROWN, K., Cohomology of groups, *Graduate Text in Math.* 87, Springer, 1982.
- BROWN, R., The twisted Eilenberg-Zilber theorem, *Celebrazioni Arch. Secolo XX, Simp. Top.* (1967), 34–37.
- BROWN, R., LODAY, J.-L., Van Kampen theorems for diagrams of spaces, *Topology* 26 (1987), 311–335. 88m:55008
- BRYLINSKI, J.-L., Cyclic homology and equivariant theories, *Ann. Inst. Fourier* 37 (1987), 15–28. 89j:55008
- BRYLINSKI, J.-L., Some examples of Hochschild and cyclic homology, *Springer Lect. Notes in Math.* 1271 (1987), 33–72. 90e:22018
- BRYLINSKI, J.-L., A differential complex for Poisson manifolds, *J. Diff. Geom.* 28 (1988), 93–114. 89m:58006
- BRYLINSKI, J.-L., Central localization in Hochschild homology, *J. Pure Applied Alg.* 57 (1989), 1–4. 90b:18015
- BRYLINSKI, J.-L., GETZLER, E., The homology of algebras of pseudo-differential symbols and the non-commutative residue, *K-theory 1* (1987), 385–403. 89j:58135
- BURGHLEA, D., The cyclic homology of the group rings, *Comment. Math. Helv.* 60 (1985), 354–365. 88e:18007

- BURGHELEA, D., Cyclic homology and the algebraic K-theory of spaces I, Proc. Summer Inst. on Alg. K-theory, Boulder Colorado 1983, *Contemp. Math.* 55, I (1986), 89–115. 88i:18009a
- BURGHELEA, D., FIEDOROWICZ, Z., Cyclic homology and algebraic K-theory of spaces II, *Topology* 25 (1986), 303–317. 88i:18009b
- BURGHELEA, D., FIEDOROWICZ, Z., GAJDA, W., Adams operations in Hochschild and cyclic homology of the de Rham algebra and free loop spaces, *K-theory* 4 (1991), 269–287.
- BURGHELEA, D., FIEDOROWICZ, Z., GAJDA, W., Power maps and epicyclic spaces, *J. Pure Applied Algebra* 96 (1994), 1–14.
- BURGHELEA, D., OGLE, C., The Künneth formula in cyclic homology, *Math. Zeit.* 193 (1986) 527–536. 88a:18015
- BURGHELEA, D., VIGUÉ-POIRRIER, M., Cyclic homology of commutative algebras I, *Springer Lect. Notes in Math.* 1318 (1988), 51–72. 89k:18027
- CALVO, A., Homologie de Hochschild et homologie cyclique de certaines algèbres de matrices triangulaires, *C. R. Acad. Sci. Paris Sér. A-B* 306 (1988), 103–105. 89c:18018
- CARLSSON, G., Homotopy fixed points in the algebraic K-theory of certain infinite discrete groups, *London Math. Soc. Lect. Note Ser.* 139 (1989), 5–10. 91c:19002
- CARLSSON, G.E., COHEN, R.L., The cyclic groups and the free loop space, *Comment. Math. Helv.* 62 (1987), 423–449. 88j:55006
- CARLSSON, G.E., COHEN, R.L., GOODWILLIE, T., HSIANG, W.-C., The free loop space and the algebraic K-theory of spaces, *K-theory* 1 (1987), 53–82.
- CARTAN, H., EILENBERG, S., Homological algebra, Princeton University Press, 1956.
- CARTIER, P., Homologie cyclique: Rapport sur les travaux récents de Connes, Karoubi, Loday, Quillen, Exposé 621, Séminaire Bourbaki, fév. 1984, *Astérisque* 121/122 (1985), 123–146. 86e:18012
- CATHELINÉAU, J.-L., Homologie de degré 3 d'algèbres de Lie simples déployées étendues à une algèbre commutative, *Ens. Math. II Ser.* 33 (1987), 159–173. 88k:17015
- CATHELINÉAU, J.-L., Sur l'homologie de SL_2 à coefficients dans l'action adjointe, *Math. Scand.* 63 (1988), 51–86. 90h:57054
- CATHELINÉAU, J.-L., Lambda structures in algebraic K-theory and cyclic homology, *K-theory* 4 (1991), 591–606.
- CHEEGER, J., SIMONS, J., Differential characters and geometric invariants, *Springer Lect. Notes in Math.* 1167 (1985), 50–80.
- CHEVALLEY, C., EILENBERG, S., Cohomology theory of Lie groups and Lie algebras, *Trans. AMS* 63 (1948), 85–124.
- CIBILS, C., Hochschild homology of an algebra whose quiver has no oriented cycles, *Springer Lect. Notes in Math.* 1177 (1986), 55–59. 88b:16049
- CIBILS, C., Cyclic and Hochschild homology of 2-nilpotent algebras, *K-theory* 4 (1990), 131–141. 91j:19007
- CLAUWENS, F.J.B.J., The classification of reduced squaring operations in cyclic homology, (work in progress).
- COHEN, R.L., A model for the free loop space of a suspension, *Springer Lect. Notes in Math.* 1286 (1987), 193–207. 89d:55018
- COHEN, R.L., JONES, J.D.S., Algebraic K-theory of spaces and the Novikov conjecture, *Topology* 29 (1990), 317–344. 91i:19001
- CONNES, A., A survey of foliations and operator algebras, *Proc. Symp. Pure Math.* 38, AMS (1982), 521–628.
- CONNES, A., Cohomologie cyclique et foncteurs Ext^n , *C. R. Acad. Sci. Paris Sér. A-B* 296 (1983), 953–958. 86d:18007

- CONNES, A., Non-commutative differential geometry, *Publ. Math. IHES* 62 (1985) 257–360. 87i:58162
- CONNES, A., Cyclic cohomology and non-commutative differential geometry, *Proc. Intern. Cong. Math., Berkeley* (1986), 879–889. 89h:58182
- CONNES, A., Cyclic homology and the transverse fundamental class of a foliation, *Geom. methods in oper. algebra* (Kyoto 1983) *Pitman Res. Notes Math. Ser.* 123 (1986), 52–144. 88k:58149
- CONNES, A., Entire cyclic cohomology of Banach algebras and characters of θ -summable Fredholm modules, *K-theory* 1 (1988), 519–548. 90c:46094
- CONNES, A., Non commutative geometry, *NATO Adv. Sci. Inst. Ser. B Phys.*, 183 (1988), 33–69.
- CONNES, A., Introduction à la géométrie non commutative, *Proc. Symp. Pure Math.* 50 (1990), 91–118.
- CONNES, A., Géométrie non commutative, Interéditions, Paris, 1990.
- CONNES, A., Essays on physics and non-commutative geometry, in *The Interface of Mathematics and Particle Physics*, Clarendon Press (1990), 9–48.
- CONNES, A., Caractères des représentations theta-sommables des groupes discrets, *C. R. Acad. Sci. Paris Sér. A-B* 312 (1991), 661–666.
- CONNES, A., On the Chern character of θ -summable Fredholm modules, *Comm. Math. Phys.* 139 (1991), 171–181.
- CONNES, A., CUNTZ, J., Quasi-homomorphismes, cohomologie cyclique et positivité, *Comment. Math. Phys.* 114 (1988), 515–526. 89h:46098
- CONNES, A., GROMOV, M., MOSCOVICI, H., Conjectures de Novikov et fibrés presque plats, *C. R. Acad. Sci. Paris Sér. A-B* 310 (1990), 273–277. 91e:57041
- CONNES, A., GROMOV, M., MOSCOVICI, H., Group cohomology with Lipschitz control and higher signatures, *Geom. Funct. Anal.* 3 (1993), 1–78.
- CONNES, A., HIGSON, N., Déformations, morphismes asymptotiques et K-théorie bivalente, *C. R. Acad. Sci. Paris Sér. A-B* 311 (1990), 101–106.
- CONNES, A., KAROUBI, M., Caractère multiplicatif d'un module de Fredholm, *C. R. Acad. Sci. Paris Sér. A-B* 299 (1984), 963–968, et *K-theory* 2 (1988), 431–463. 90c:58174
- CONNES, A., MOSCOVICI, H., Transgression du caractère de Chern et cohomologie cyclique, *C. R. Acad. Sci. Paris Sér. A-B* 303 (1986), 913–918. 88c:58006
- CONNES, A., MOSCOVICI, H., Cyclic cohomology, the Novikov conjecture and hyperbolic groups, *Topology* 29 (1990), 345–388. 92a:58137
- CONNES, A., SKANDALIS, G., The longitudinal index theorem for foliations, *Publ. Res. Inst. Math. Sci.* 20 (1984), 1139–1183.
- COQUEREAUX, R., Non-commutative geometry and theoretical physics, *J. Geom. and Phys.* 6 (1989), 425–490.
- COQUEREAUX, R., KASTLER, D., Remarks on the differential envelopes of associative algebras, *Pacific J. Math.* 137 (1989), 245–263. 90g:16003
- CORTINAS, G., GUCCIONE, J., VILLAMAYOR, O.E., Cyclic homology of $K[\mathbb{Z}/p\mathbb{Z}]$, *K-theory* 2 (1989), 603–616. 90i:18006
- CORTINAS, G., VILLAMAYOR, O.E., Cyclic homology of $K[\mathbb{Z}/2\mathbb{Z}]$, *Rev. Un. Mat. Argent.* 33 (1987), 55–61.
- CUNTZ, J., A new look at KK-theory, *K-theory* 1 (1987), 31–51.
- CUNTZ, J., Universal extensions and cyclic cohomology, *C. R. Acad. Sci. Paris Sér. A-B* 309 (1989), 5–8. 91a:19002
- CUNTZ, J., QUILLEN, D., Algebra extensions and nonsingularity, *J. Amer. Math. Soc.* 8 (1995), 251–289.
- CUVIER, C., Homologie de Leibniz et homologie de Hochschild, *C. R. Acad. Sci. Paris Sér. A-B* 313 (1991), 569–572.

- DE CONCINI, C., PROCESI, C., A characteristic free approach to invariant theory, *Advances in Maths* 21 (1976), 330–354.
- DENNIS, K., In search of a new homology theory, manuscript, 1976, never published.
- DENNIS, K., IGUSA, K., Hochschild homology and the second obstruction for pseudo-isotopy, *Springer Lect. Notes in Math.* 966 (1982), 7–58. 84m:18014
- DENNIS, K., STEIN, M., K_2 of radical ideals and semi-local rings revisited, *Springer Lect. Notes in Math.* 342 (1973), 281–303.
- DÉSARMÉNIEN, J., FOATA, D., Signed Eulerian numbers, *J. Discrete Math.* 99 (1992), 49–58.
- DOUGLAS, R.G., HURDER, S., KAMINKER, J., Cyclic cocycles, renormalization and eta-invariants, *Invent. Math.* 103 (1991), 101–179. 91m:58152
- DUNN, G., Dihedral and quaternionic homology and mapping spaces, *K-theory* 3 (1989), 141–161.
- DWYER, W.G., HOPKINS, M.J., KAN, D.M., The homotopy theory of cyclic sets, *Trans. AMS* 291 (1985), 281–289. 86m:55014
- DWYER, W.G., HSIANG, W.C., STAFFELDT, R.E., Pseudo-isotopy and invariant theory-I, *Topology* 19 (1980), 367–385.
- DWYER, W.G., KAN, D.M., Normalizing the cyclic modules of Connes, *Comment. Math. Helv.* 60 (1985) 582–600.
- DWYER, W.G., KAN, D.M., Three homotopy theories for cyclic modules, Proc. Northw. Conf. on Cohomology groups, *J. Pure Applied Algebra* 44 (1987), 165–175. 88f:18022
- ECKMANN, B., Cyclic homology of groups and the Bass conjecture, *Comment. Math. Helv.* 61 (1986), 193–202. 87i:18008
- ELLIOT, G.A., NATSUME, T., NEST, R., Cyclic cohomology for one-parameter smooth crossed products, *Acta Math.* 160 (1988), 285–305. 89h:46093
- ELLIOT, G.A., NEST, R., RORDAM, M., The cyclic homology of algebras with adjoined units, *Proc. A.M.S.* 113 (1991), 389–395. 91m:19004
- ELLIS, G., Multirelative algebraic K-theory: the group $K_2(\Lambda; I_1, \dots, I_n)$ and related computations, *J. Algebra* 112 (1988), 271–289.
- ESNAULT, H., On the Loday symbol in Deligne-Beilinson cohomology, *K-theory* 3 (1989), 1–28. 90j:14025
- FACK, T., Sur la conjecture de Novikov, *Contemp. Math.* 70 (1988), 43–102. 90e:58150
- FEIGIN, B.L., TSYGAN, B.L., Cohomologie de l'algèbre de Lie des matrices de Jacobi généralisées (en russe), *Funct. Anal. and Appl.* 17(2) (1983), 86–87. 85c:17008
- FEIGIN, B.L., TSYGAN, B.L., Additive K-theory and crystalline cohomology (in russian), *Funkt. Anal. i. Pril.* 19 (2) (1985), 52–62 88e:18008
- FEIGIN, B.L., TSYGAN, B.L., Additive K-theory, in “K-theory, Arithmetic and Geometry”, *Springer Lect. Notes in Math.* 1289 (1987), 97–209. 89a:18017
- FEIGIN, B.L., TSYGAN, B.L., Cyclic homology of algebras with quadratic relations, universal enveloping algebras and group algebras, in “K-theory, Arithmetic and Geometry”, *Springer Lect. Notes in Math.* 1289 (1987), 210–239. 89c:17020
- FENG, P., TSYGAN, B.L., Hochschild and cyclic homology of quantum groups, *Comment. Math. Phys.* 140 (1991), 481–521.
- FIEDOROWICZ, Z. The symmetric bar construction, preprint.
- FIEDOROWICZ, Z., GAJDA, W., The S^1 -CW-decomposition of the geometric realization of a cyclic set, preprint.
- FIEDOROWICZ, Z., LODAY, J.-L., Crossed simplicial groups and their associated homology, *Trans. Amer. Math. Soc.* 326 (1991), 57–87. 91j:18018
- FIEDOROWICZ, Z., OGLE, C., VOGT, Volodin K-theory of A_∞ -ring spaces, *Topology* 32 (1993), 329–352.

- FORMANEK, E., The polynomial identities and invariant $n \times n$ -matrices, *CBMS Lect. Note* 78, 1990.
- FOX, R.H., Free differential calculus, *Ann. Math.* 57 (1953), 547–560.
- GABRIEL, P., ZISMAN, M., Calculus of fractions and homotopy theory, *Erg. Math.*, Springer, 1967.
- GAUCHER, P., Produit tensoriel de matrices et homologie cyclique, *C. R. Acad. Sci. Paris Sér. A-B* 312 (1991), 13–16. 91m:19005
- GAUCHER, P., Lambda-opérations et homologie des matrices, *C. R. Acad. Sci. Paris Sér. A-B* 313 (1991), 663–666.
- GELFAND, I.M., DALETSKII, Y.L., TSYGAN, B.L., On a variant of noncommutative differential geometry. *Dokl. Akad. Nauk SSSR* 308 (1989), 1293–1297. 91j:58015
- GELFAND, I.M., MATHIEU, O., On the cohomology of the Lie algebra of Hamiltonian vector fields, *RIMS, Tokyo, No. 781* (1991), 10p.
- GELLER, S., REID, L., WEIBEL, C., The cyclic homology and K-theory of curves, *J. Reine Ang. Math.* 393 (1989), 39–90. 89m:14006
- GELLER, S., WEIBEL, C., Hochschild and cyclic homology are far from being homotopy functors, *Proc. Amer. Math. Soc.* 106 (1989), 49–57. 89i:18010
- GELLER, S., WEIBEL, C., Etale descent for Hochschild and cyclic homology, *Comment. Math. Helv.* 66 (1991), 368–388.
- GERSTENHABER, M., SCHACK, S.D., A Hodge-type decomposition for commutative algebra cohomology, *J. Pure Applied Algebra* 48 (1987), 229–247.
- GERSTENHABER, M., SCHACK, S.D., Algebra cohomology and deformation theory, in “Deformation Theory of Algebras and Structures, and Applications”. Kluwer (1988), 11–264.
- GERSTENHABER, M., SCHACK, S.D., The shuffle bialgebra and the cohomology of commutative algebras, *J. Pure Appl. Algebra* 70 (1991), 263–272.
- GETZLER, E., Cyclic homology and the Beilinson-Manin-Schechtman central extensions, *Proc. Amer. Math. Soc.* 104 (1988), 729–734. 89h:17014
- GETZLER, E., JONES, J.D.S., A_∞ -algebras and the cyclic bar complex, *Illinois J. Math.* 34 (1990), 256–283. 91e:19001
- GETZLER, E., JONES, J.D.S., PETRACK, S.B., Loop spaces, cyclic homology and the Chern character, Proc. US-UK Operator algebras, *London Math. Lect. Ser.* 135 (1988), 95–107. 90g:58124
- GETZLER, E., JONES, J.D.S., PETRACK, S.B., Differential forms on loop spaces and the cyclic bar complex, *Topology* 30 (1991), 339–371.
- GETZLER, E., SZENES, A., On the Chern character of a theta-summable Fredholm module, *J. Funct. Anal.* 89 (1989), 343–358.
- GHYS, E., L’invariant de Godbillon-Vey, Séminaire Bourbaki No. 706, *Astérisque* 177–178 (1989), 155–181.
- GOICHOT, F., Homologie de Tate-Vogel équivariante, *J. Pure Appl. Algebra* 82 (1992), 39–64.
- GOODWILLIE, T.G., Cyclic homology, derivations and the free loop space, *Topology* 24 (1985), 187–215. 87c:18009
- GOODWILLIE, T.G., On the general linear group and Hochschild homology, *Ann. of Math.* 121 (1985), 383–407, correction idem 124 (1986), 627–628, 86i:18013
- GOODWILLIE, T.G., Relative algebraic K-theory and cyclic homology, *Ann. of Math.* 124 (1986), 347–402. 88b:18008
- GRAYSON, D., Adams operations on higher K-theory, *K-theory* 6 (1992), 97–111.
- GROS, M., Quelques résultats sur l’homologie cyclique des algèbres en caractéristique positive, *C. R. Acad. Sci. Paris Sér. A-B* 304 (1987), 139–142. 88i:18015
- GROTHENDIECK, A., Produits tensoriels topologiques, *Memoirs A.M.S.* 16, 1955.
- GUCCIONE, J.A., GUCCIONE, J.J., Cyclic homology of monogenic extensions, *J. Pure Appl. Algebra* 66 (1990), 251–269.

- GUIN, D., Sur le groupe K_3 d'un anneau, *Springer Lect. Notes in Math.* 967 (1982), 81–100.
- GUIN, D., Cohomologie et homologie non abéliennes des groupes, *J. Pure Appl. Algebra* 50 (1988), 109–137.
- GUIN, D., Homologie du groupe linéaire et K-théorie de Milnor des anneaux, *J. Alg.* 123 (1989) 27–59.
- GUIN-WALÉRY, D., LODAY, J.-L., Obstruction à l'excision en K-théorie algébrique, *Springer Lect. Notes in Math.* 854 (1981), 179–216.
- HAEFLIGER, A., The homology of nilpotent Lie groups made discrete, *Astérisque* 113–114 (1984), 206–211.
- HAIN, R.M., On the indecomposable elements of the bar construction, *Proc. Amer. Math. Soc.* 98 (1986), 312–316.
- HANLON, P., Cyclic homology and the Macdonald conjectures, *Invent. Math.* 86 (1986), 131–159. 88b:17019
- HANLON, P., On the complete $GL(n, \mathbb{C})$ -decomposition of the stable cohomology of $gl_n(A)$, *Trans. AMS* 308 (1988), 209–225. 90k:17040
- HANLON, P., The action of S_n on the components of the Hodge decomposition of Hochschild homology, *Mich. Math. J.* 37 (1990), 105–124.
- HANLON, P., WALES, On the homology of $(t\mathbb{C}[t])$ and a theorem of Stembridge, preprint.
- HARRISON, D.K., Commutative algebras and cohomology, *Trans. AMS* 104 (1962), 191–204.
- HIGSON, N., A primer on KK-theory, *Proc. Symp. Pure Math.* 51 (1990), 239–283.
- HILSUM, M., SKANDALIS, G., Invariant par homotopie de la signature à coefficients dans un fibré presque plat, *J. Reine Ang. Math.* 423 (1992), 73–99.
- HOCHSCHILD, G., On the cohomology groups of an associative algebra, *Annals of Math.* 46 (1945), 58–67.
- HOCHSCHILD, G., Relative homological algebra, *Trans. AMS* 82 (1956), 246–269.
- HOCHSCHILD, G., KOSTANT, B., ROSENBERG, A., Differential forms on regular affine algebras, *Trans. AMS* 102 (1962), 383–408. 26# 167
- HOOD, C., JONES, J.D.S., Some algebraic properties of cyclic homology groups, *K-theory* 1 (1987), 361–384. 89f:18011
- HSIANG, W.-C., STAFFELDT, R.E., A model for computing rational algebraic K-theory of simply connected spaces, *Invent. Math.* 68 (1982), 227–239. 84h:18015
- IGUSA, K., Notes on the no loops conjecture, *J. Pure Appl. Alg.* 69 (1990), 161–176.
- JAFFE, A., LESNIEWSKI, A., OSTERWALDER, K., Quantum K-theory.I. The Chern character, *Comm. Math. Phys.* 118 (1988), 1–14. 90a:58170
- JAFFE, A., LESNIEWSKI, A., OSTERWALDER, K., On super-KMS functionals and entire cyclic cohomology, *K-theory* 2 (1989), 675–682. 91b:46071
- JAFFE, A., LESNIEWSKI, A., WEITSMAN, J., The loop space S^1R and supersymmetry quantum fields, *Ann. Phys.* 183 (1988), 337–351. 89i:58135
- JONES, J.D.S., Cyclic homology and equivariant homology, *Invent. Math.* 87 (1987), 403–423. 88f:18016
- JONES, J.D.S., KASSEL, C., Bivariant cyclic theory, *K-theory* 3 (1989), 339–366. 91f:19001
- JONES, J.D.S., PETRACK, S.B., The fixed point theorem in equivariant cohomology, *Trans. AMS* 322 (1990), 35–49.
- JULG, P., VALETTE, A., K-theoretic amenability of $SL_2(\mathbb{Q}_p)$ and the action of the associated tree, *J. Funct. Analysis* 58 (1984), 194–215
- KADISON, L., A relative cyclic cohomology theory useful for computation, *C. R. Acad. Sci. Paris Sér. A-B* 308 (1989), 569–573. 90k:18014

- KADISON, L., On the cyclic cohomology of nest algebras and a spectral sequence induced by a subalgebra in Hochschild cohomology, *C. R. Acad. Sci. Paris Sér. A-B* 311 (1990), 247–252. 91j:46090
- KALLEN van der, W., MAAZEN, H., STIENSTRA, A.J., A presentation for some $K_2(n, R)$, *Bull. AMS* 81 (1975), 934–936. 51#12993
- KAN, D.M., THURSTON, Every connected space has the homology of a $K(\pi, 1)$, *Topology* 15 (1976), 253–258.
- KAROUBI, M., K-theory, an introduction, *Grund. Math. Wissen.* 226, Springer, 1978.
- KAROUBI, M., Homologie cyclique et régulateurs en K-théorie algébrique, *C. R. Acad. Sci. Paris Sér. A-B* 297 (1983), 557–560. 85f:18006
- KAROUBI, M., Homologie cyclique des groupes et des algèbres, *C. R. Acad. Sci. Paris Sér. A-B* 297 (1983), 381–384. 85g:18012
- KAROUBI, M., Homologie cyclique et K-théorie algébrique I et II, *C. R. Acad. Sci. Paris Sér. A-B* 297 (1983), 447–450 et 513–516. 85g :18013
- KAROUBI, M., Formule de Künneth en homologie cyclique I et II, *C. R. Acad. Sci. Paris Sér. A-B* 303 (1986), 527–530 et 595–598. 88c:18006
- KAROUBI, M., K-théorie multiplicative et homologie cyclique, *C. R. Acad. Sci. Paris Sér. A-B* 303 (1986), 507–510. 88a:18017
- KAROUBI, M., K-théorie multiplicative, *C. R. Acad. Sci. Paris Sér. A-B* 302 (1986), 321–324.
- KAROUBI, M., Homologie cyclique et K-théorie, *Astérisque* 149, 1987. 89c:18019
- KAROUBI, M., Cyclic homology and characteristic classes of bundles with additional structures, *Springer Lect. Notes in Math.* 1370 (1989), 235–242. 89c:18019
- KAROUBI, M., Théorie générale des classes caractéristiques secondaires. *K-theory* 4 (1990), 55–87.
- KAROUBI, M., VILLAMAYOR, O.E., Homologie cyclique d'algèbres de groupes, *C. R. Acad. Sci. Paris Sér. A-B* 311 (1990), 1–3.
- KASSEL, C., A Künneth formula for the cyclic cohomology of $\mathbb{Z}/2$ -graded algebras, *Math. Ann.* 275 (1986), 683–699. 88a:18018
- KASSEL, C., Cyclic homology, comodules and mixed complexes, *J. of Algebra* 107 (1987), 195–216. 88k:18019
- KASSEL, C., K-théorie algébrique et cohomologie cyclique bivariantes, *C. R. Acad. Sci. Paris Sér. A-B* 306 (1988), 799–802. 89j:18012
- KASSEL, C., L'homologie cyclique des algèbres enveloppantes, *Invent. Math.* 91 (1988), 221–251. 89e:17015
- KASSEL, C., Caractère de Chern bivariant, *K-theory* 3 (1989), 367–400. 91f:19002
- KASSEL, C., Quand l'homologie cyclique périodique n'est pas la limite projective de l'homologie cyclique, *K-theory* 2 (1989), 617–621. 90i:18007
- KASSEL, C., Homologie cyclique, caractère de Chern et lemme de perturbation, *J. Reine u. Ang. Math.* 408 (1990), 159–180.
- KASSEL, C., LODAY, J.-L., Extensions centrales d'algèbres de Lie, *Ann. Inst. Fourier* 33 (1982), 119–142. 85g:17004
- KASTLER, D., $\mathbb{Z}/2$ -graded cyclic cohomology within the differential envelope, *Contemp. Math.* 62, *Operator Algebras and Math. Physics* (1987), 221–236. 88d:58006
- KASTLER, D., Cyclic cohomology within the differential envelope, *Travaux en cours* 30, Hermann, 1988, (184 p.). 89h:18013
- KASTLER, D., Cyclic cocycles from graded KMS functionals, *Comment Math. Phys.* 121 (1989), 345–350.
- KASTLER, D., Entire cyclic cohomology of $\mathbb{Z}/2$ -graded Banach algebras, *K-theory* 2 (1989), 485–509.
- KASTLER, D., Introduction to entire cyclic cohomology, in *Stochastics, alg. anal. class. quantum mecha.*, Academic Press (1990), 73–153.

- KERVAIRE, M., Multiplicateurs de Schur et K-théorie, Essays on Topology and related topics, Springer, (1970), 212–225.
- KEUNE, F., The relativization of K_2 , *J. Alg.* 54 (1978), 159–177. 80a:18013
- KLIMEK, S., KONDRAKI, W., LESNIEWSKI, A., Equivariant entire cyclic cohomology : I. Finite groups, *K-theory* 4 (1991), 201–218.
- KLIMEK, S., LESNIEWSKI, A., Chern character in equivariant entire cyclic cohomology, *K-theory* 4 (1991), 219–226.
- KOSTANT, B., A theorem of Frobenius, a theorem of Amitsur-Levitzki and cohomology theory, *J. Math. Mech.* 7 (1958), 237–264.
- KOSZUL, J.L., Sur les opérateurs de dérivations dans un anneau, *C. R. Acad. Sci. Paris Sér. A-B* 225 (1947), 217–219.
- KOSZUL, J.L., Homologie et cohomologie des algèbres de Lie, *Bull. Soc. Math. France* 78 (1950), 65–127. 12# 120
- KRASAUSKAS, R.L., Skew simplicial groups, *Litovsk. Mat. Sb.* 27 (1987) No. 1, 89–99. 88m:18022
- KRASAUSKAS, R.L., LAPIN, S.V., SOLOVEV, Yu. P., Dihedral homologies and cohomologies, *Vestnik Moskov. Univ. Ser. I Mat. Mekh.* 102 No. 4 (1987), 28–32. 88m:18021
- KRASAUSKAS, R.L., LAPIN, S.V., SOLOVEV, Yu. P., Dihedral homology and cohomology, Basic notions and constructions. *Mat. Sb.* 133:1 (1987), 25–48. 88i:18014
- KRASAUSKAS, R.L., SOLOVEV, Yu. P., Dihedral homology and Hermitian K-theory of topological spaces, *Russian Math. Surveys* 41 (2) (1986), 203–204. 87h:18015
- KRASAUSKAS, R.L., SOLOVEV, Yu. P., Rational hermitian K-theory and dihedral homology, *Izv. Akad. Nauk SSSR* 52 (1988), 935–969.
- LAPIN, S.V., Normalization of reflexive and dihedral modules, *Mat. Zametki* 48 (1990), 61–67.
- LAPIN, S.V., Dihedral homologies of $A[x]$, $A[x, x^{-1}]$ and of some other algebras, *Mat. Zametki* 41, 2 (1987), 238–247, 287 (russian) English transl. *Math. Notes* 41 (1987), No. 1–2, 137–142. 88e:18013
- LIPMAN, J., Residues and traces of differential forms via Hochschild homology, *Contemporary Mathematics* 61, 1987.
- LODAY, J.-L., K-théorie algébrique et représentations de groupes, *Ann. Sc. Ec. Norm. Sup.* 9 (1976), 309–377. 56# 5686
- LODAY, J.-L., Cohomologie et groupe de Steinberg relatifs, *J. Alg.* 54 (1978), 178–202. 80b:18013
- LODAY, J.-L., On the boundary map $K_3(\Lambda/I) \rightarrow K_2(\Lambda, I)$, in Alg. K-th. (Evanston 1980), *Springer Lect. Notes in Math.* 854 (1981), 262–268. 82h:18009a
- LODAY, J.-L., Symboles en K-théorie algébrique supérieure, *C. R. Acad. Sci. Paris Sér. A-B* 292 (1981), 863–866. 82f:13005
- LODAY, J.-L., Spaces with finitely many homotopy groups, *J. Pure Appl. Algebra* 24 (1982), 179–202.
- LODAY, J.-L., Cyclic homology a survey, *Geom. and Alg. Topology*, *Banach Center Pub.* 18, PWN Warszawa (1986), 281–303. 89e:18023
- LODAY, J.-L., Homologies diédrale et quaternionique, *Advances in Math.* 66 (1987), 119–148. 89e:18024
- LODAY, J.-L., Comparaison des homologies du groupe linéaire et de son algèbre de Lie, *Ann. Inst. Fourier* 37 (1987), 167–190. 89i:17011
- LODAY, J.-L., Opérations sur l'homologie cyclique des algèbres commutatives, *Invent. Math.* 96 (1989), 205–230. 89m:18017
- LODAY, J.-L., PIRASHVILI, T., Universal enveloping algebras of Leibniz algebras and (co)homology, *Math. Annalen* 296 (1993), 139–158.
- LODAY, J.-L., PROCESI, C., Homology of symplectic and orthogonal algebras, *Advances in Math.* 69 (1988), 93–108. 89k:17035

- LODAY, J.-L., PROCESI, C., Cyclic homology and λ -operations, in Proc. Lake Louise Conf. Canada NATO-ASI Ser. C, 279 (1989), 209–224. 91e:19002
- LODAY, J.-L., QUILLEN, D., Homologie cyclique et homologie de l'algèbre de Lie des matrices, *C. R. Acad. Sci. Paris Sér. A-B* 296 (1983), 295–297. 85d:17010
- LODAY, J.-L., QUILLEN, D., Cyclic homology and the Lie algebra homology of matrices, *Comment. Math. Helvetici* 59 (1984), 565–591. 86i:17009
- LODDER, J.M., Dihedral homology and the free loop space, *Proc. London Math. Soc.* 60 (1990), 201–224. 91a:55007
- LODDER, J.M., Cyclic homology and de Rham cohomology, *Mathematische Zeitschrift* 208 (1991), 489–502.
- LODDER, J.M., Dihedral homology and Hermitian K-theory, *K-theory*, to appear
- MAC LANE, S., Homology, *Grundlehren Math. Wiss.* 114, Springer, 1963.
- MAGURN, B.A., ed., Reviews in K-theory : 1940–84. AMS (1984).
- MANIN, Y.I., Topics in noncommutative geometry, Princeton Univ. Press, 1991.
- MARCINIAK, Z., Cyclic homology and idempotent in group rings. *Springer Lect. Notes in Math.* 1217 (1985), 253–257. 89b:20023
- MASUDA, T., Dualité pour le produit croisé différentiel et sa cohomologie cyclique périodique, *C. R. Acad. Sci. Paris Sér. A-B* 301 (1985), 551–553. 86m:46071
- MASUDA, T., Cyclic cohomology of $A[x]$ and $A[x, x^{-1}]$, *Publ. Res. Inst. Math. Sci. Kyoto Univ.* 22 (1986), 365–393. 87j:18016
- MASUDA, T., Cyclic cohomology of the group algebra of free groups, *J. Operator Theory* 15 (1986), 345–357. 88a:46086
- MASUDA, T., NAKAGAMI, Y., WATANABE, J., Non-commutative Differential Geometry on the quantum $SU(2)$. I: an algebraic view-point. *K-theory* 4 (1990), 157–180.
- MASUDA, T., NATSUME, T., Cyclic cohomology of certain affine schemes, *Publ. Res. Inst. Math. Sci. Kyoto Univ.* 21 (1985), 1261–1279. 87k:13020
- MATSUMURA, A., Commutative ring theory, Cambridge University Press, 1986.
- MAY, J.P., Simplicial objects in algebraic topology, Van Nostrand, Princeton, 1967.
- MCCARTHY, R., L'équivalence de Morita et l'homologie cyclique, *C. R. Acad. Sci. Paris Sér. A-B* 307 (1988), 211–215. 89k:18028
- MCCARTHY, R., On operations for Hochschild homology, *Comm. Alg.* 21, (1993), 2947–2965.
- MCCARTHY, R., The cyclic homology of an exact category, *J. Pure Appl. Algebra* 93 (1994), 251–296.
- MILNOR, J., Introduction to algebraic K-theory, *Ann. Math. Studies* 72, Princeton U. Press, 1974.
- MILNOR, J., MOORE, J.C., On the structure of Hopf algebras, *Ann. Math.* 81 (1965) 211–264.
- MILNOR, J., STASHEFF, J.D., Characteristic classes, *Annals of Math. Studies* 76, Princeton University Press, 1974.
- MOSCOVICI, H., Cyclic cohomology and invariants of non simply-connected manifolds, *Proc. I.C.M Kyoto* (1990)
- MUZERE, M., Relative Lie algebra cohomology, *J. Pure App. Alg.* 58 (1989), 77–91.
- NATSUME, T., NEST, R., The cyclic cohomology of compact Lie groups and the direct sum formula, *J. Operator Theory* 23 (1990), 43–50. 91k:22017
- NATSUME, T., SCHACK, S.D., A decomposition for the cyclic cohomology of a commutative algebra, *J. Pure App. Alg.* 61 (1989), 273–282. 90k:13010
- NEST, R., Cyclic cohomology of crossed products with \mathbb{Z} , *J. Funct. Anal.* 80 (1988), 235–283. 90c:46088
- NEST, R., Cyclic cohomology of non commutative tori, *Can. J. Math.* 40 (1988), 1046–1057. 90c:46089

- NICAS, A.J., Mixed Hodge structure in cyclic homology and algebraic K-theory, *K-theory* 1 (1987), 437–456. 89f:18007
- NISTOR, V., Group cohomology and the cyclic cohomology of cross-product, *Invent. Math.* 99 (1990), 411–424. 91f:46097
- NISTOR, V., A bivariant Chern character for p -summable quasi-homomorphisms, *K-theory* 5 (1991), 193–211.
- NISTOR, V., Cyclic cohomology of crossed product by algebraic groups, *Invent. Math.* 112, (1993), 615–638.
- NOVIKOV, S.P., Analogues hermitiens de la K-théorie, *Actes Congrès Inter. Math. t.II* (1970), 39–45.
- NUSS, P., L'homologie cyclique des algèbres enveloppantes des algèbres de Lie de dimension 3, *J. Pure Appl. Algebra* 73 (1991), 39–71.
- NUSS, P., Décomposition de la cohomologie cyclique bivariante des algèbres commutatives, *Math. Scand.* 70, (1992), 5–26.
- OGLE, C., On the K-theory and cyclic homology of a square zero ideal I, *J. Pure Applied Algebra* 46 (1987), 233–247. 88j:18007
- OGLE, C., WEIBEL, C., Relative K-theory and cyclic homology, preprint.
- PARK, E., Index theory and Toeplitz algebras on certain cones in \mathbb{Z}^2 , *J. Op. Theory* 23 (1990), 125–146. 91i:47039
- PATRAS, F., Filtration du groupe des polytopes et λ -structure du groupe symétrique, *C. R. Acad. Sci. Paris Sér. A-B* 310 (1990), 501–504. 91g:52050
- PATRAS, F., Construction géométrique des idempotents Eulériens. Filtration des groupes de polytopes et des groupes d'homologie de Hochschild, *Bull. SMF* 119 (1991), 173–198.
- PERELYGIN, S.I., Cyclic (co)homology of pre-additive categories, *Dokl. Akad. Nauk SSSR* 11 (1990), 974–977.
- PICKEL, P.F., Rational cohomology of nilpotent groups and Lie algebras, *Comm. in Alg.* 6 (1978), 409–419.
- PIMSNER, M., VOICULESCU, D., The irrational rotation C^* -algebra into an AF-algebra, *J. Op. Theory* 8 (1982), 131–156.
- PIRASHVILI, T., Plus-construction for Lie algebras, *Soobsch Akad. Nauk Gruzin SSR* 118 (1985), 253–256. 87e:18012
- PIRASHVILI, T., Analogue de la construction + de Quillen pour les algèbres de Lie, *Trydy Tbilisskovo Mat. Inst.* 78 (1986), 44–78. 87m:18020
- PIRASHVILI, T., WALDHAUSEN, F., Mac Lane homology and topological Hochschild homology, *J. Pure Appl. Algebra* 82 (1992), 81–98.
- PROCESI, C., The invariant theory of $n \times n$ -matrices, *Adv. in Math.* 19 (1976), 306–381.
- PROCESI, C., Trace identities and standard diagrams, in Ring theory, *Proc. Antw. Conf. 1978*, Dekker (1979), 191–218.
- QUILLEN, D., Rational homotopy theory, *Ann. of Maths* 90 (1969), 205–295. 41,1# 2678
- QUILLEN, D., On the (co)-homology of commutative rings, *Proc. Symp. Pure Math.* 17 (1970), 65–87.
- QUILLEN, D., On the cohomology and K-theory of the general linear group over a finite field, *Ann. of Maths* 96 (1972), 552–586. 47# 3565
- QUILLEN, D., Higher algebraic K-theory I, *Springer Lect. Notes in Math.* 341 (1973), 85–147.
- QUILLEN, D., Finite generation of the group K_2 of algebraic integers, *Springer Lect. Notes in Math.* 341 (1973), 179–198. 50# 2305
- QUILLEN, D., Algebra cochains and cyclic cohomology, *Publ. Math. IHES* 68 (1988) 139–174. 90j:18008

- QUILLEN, D., Cyclic cohomology and algebra extensions. *K-theory* 3 (1989), 205–246.
- QUILLEN, D., Chern-Simons forms and cyclic cohomology, in *The Interface of Math. and Particle Phys.* Clarendon Press (1990), 117–134.
- REUTENAUER, C., Theorem of PBW, logarithm and representations of the symmetric group whose orders are the Stirling numbers, *Springer Lect. Notes in Math.* 1234 (1986), 267–284.
- RINEHART, G., Differential forms on general commutative algebras, *Trans. AMS* 108 (1963), 195–222. 91d:19004
- ROBERTS, L.G., Kähler differentials and HC_1 of certain graded k -algebras, in Alg. K-th., connections, *NATO-ASI, Ser. C*, 279 (1989), 389–424.
- ROE, J., An index theorem on open manifolds. I, II., *J. Diff. Geom.* 27 (1988), 87–113, 115–136. 89a:58102
- RONCO, M.O., On the Hochschild Homology decompositions, *Comm. Alg.* 21 (1993), 4699–4712.
- RONCO, M.O., Adams operations on a Hopf algebra, preprint (1992).
- ROOS, J.-E., Homology of free loop spaces, cyclic homology and nonrational Poincaré-Betti series in commutative algebras, *Springer Lect. Notes in Math.* 1352 (1988), 173–189. 90f:55020
- ROSSET, S., A new proof of the Amitsur-Levitzki identity, *Israel J. Math.* 23 (1976), 187–188.
- RYAN, J.G., Curves on K-theory and the de Rham homology of associative algebras, *Trans. AMS* 321 (1990), 559–582. 91a:19003
- SCHAFER, J.A., Traces and the Bass conjecture, *Mich. J. Math.* 38 (1991), 103–109.
- SEGAL, G., Categories and cohomology theories, *Topology* 13 (1974), 293–312.
- SEIBT, P., Cyclic homology of algebras, World Scientific Publishing Co., 1987. 89i:18013
- SEIBT, P., Local cyclic homology, *K-theory* 4 (1990), 143–155. 91k:19004
- SKANDALIS, G., Approche de la conjecture de Novikov par la cohomologie cyclique, Sémin. Bourbaki, Exposé No. 739, *Astérisque* 201–203 (1991), 299–320.
- SOLOTAR, A., Bivariant cohomology and S^1 -spaces, *Bull. Soc. Math. France* 120 (1992), 397–412.
- SOULÉ, C., On higher p -adic regulators, *Springer Lect. Notes in Math.* 854 (1980), 472–501.
- SOULÉ, C., Opérations en K-théorie algébrique, *J. Canadien de Math.* 37 (1985), 488–550.
- SOULÉ, C., Régulateurs, Séminaire Bourbaki, Exposé No. 644, *Astérisque* 133–134 (1986), 237–253.
- STAFFELDT, R.E., Rational algebraic K-theory of certain truncated polynomial rings, *Proc. AMS* 95 (1985), 191–198. 86m:18010
- STRICHARTZ, R.S., The Campbell-Baker-Hausdorff-Dynkin formula and solutions of differential equations, *J. Funct. Anal.* 72 (1987), 320–345. 89b:22011
- SUSLIN, A.A., On the equivalence of K-theories, *Comm. in Alg.* 9 (1981), 1559–1566.
- SUSLIN, A.A., Homology of GL_n , characteristic classes and Milnor K-theory, *Springer Lect. Notes in Math.* 1046 (1984), 357–375. 86f:11090a
- SUSLIN, A.A., On the K-theory of local fields, *J. Pure Appl. Algebra* 34 (1984), 301–318.
- SUSLIN, A.A., WODZICKI, M., Excision in algebraic K-theory, *Ann. of Maths.* 136 (1992), 51–122.
- TAPIA, J., Sur la pente du feuilletage de Kronecker et la cohomologie étale de l'espace des feuilles, *C. R. Acad. Sci. Paris Sér. A-B* 305 (1987), 427–429. 89c:57038

- TILLMANN, U., K-theory of fine topological algebras, Chern character and assembly, *K-theory* 6 (1992), 57–86.
- TSYGAN, B.L., The homology of matrix Lie algebras over rings and the Hochschild homology (en russe), *Uspekhi Mat. Nauk* 38 (1983), 217–218 – *Russ. Math. Survey* 38 No. 2 (1983), 198–199. 85i:17014
- TSYGAN, B.L., Homology of certain matrix Lie superalgebras, *Funct. Anal.* 20 (2) (1986), 90–91.
- TSYGAN, B.L., Relative algebraic K-theory of a two-sided nilpotent ideal, (russian), Alg. Logic Number Theory, Moscow (1986), 93–97.
- VALETTE, A., The conjecture of idempotents: a survey of the C*-algebra approach, *Bull. Soc. Math. Belg. ser. A* 41 (1989), 485–521.
- VASERSTEIN, L., The foundations of algebraic K-theory, *Uspekhi Mat. Nauk* 31 (1976), 87–149.
- VIGUÉ-POIRRIER, M., Sur l'algèbre de cohomologie cyclique d'un espace 1-connexe, applications à la géométrie des variétés, *Illinois J. Math.* 32 (1988), 40–52. 89e:55023
- VIGUÉ-POIRRIER, M., Cyclic homology and Quillen homology of a commutative algebra, Proc. Louvain-la-Neuve 1986, *Springer Lect. Notes in Math.* 1318 (1988), 238–245. 89i:18011
- VIGUÉ-POIRRIER, M., Homologie de Hochschild et homologie cyclique des algèbres différentielles graduées, *Astérisque* 191 (1990), 255–267.
- VIGUÉ-POIRRIER, M., Décompositions de l'homologie cyclique des algèbres différentielles graduées commutatives, *K-theory* 4 (1991), 399–410.
- VIGUÉ-POIRRIER, M., Cyclic homology of algebraic hypersurfaces, *J. Pure Appl. Alg.* 72 (1991), 95–108.
- VIGUÉ-POIRRIER, M., BURGHELEA, D., A model for cyclic homology and algebraic K-theory of 1-connected topological spaces, *J. Diff. Geom.* 22 (1985), 243–253. 87j:58029
- VOLODIN, I.A., Algebraic K-theory as an extraordinary homology theory on the category of associative rings with 1, *Izv. An. SSSR, Ser. Mat.* 35 (1971), 844–873.
- VUCIC, A., ZIVAJEVIC, R., Dihedral hyperhomology of a chain algebra with involution, *Publ. Inst. Math. Beograd* 49 (63) (1991), 39–50.
- WAGONER, J.B., Equivalence of algebraic K-theories, *J. Pure Appl. Alg.* 11 (1977/78), 245–269.
- WALDHAUSEN, F., Algebraic K-theory of topological spaces I, *Proc. Symp. Pure Math.* 32 AMS (1978), 35–60.
- WALDHAUSEN, F., Algebraic K-theory of topological spaces II, *Springer Lect. Notes in Math.* 1051 (1984), 173–196.
- WANG, X., Bivariant Chern character I, *Proc. Symp. Pure Math.* 51 (1990), 355–360.
- WANG, X., A bivariant Chern character II, *Canadian J. Math.* 44 (1992), 400–435.
- WASSERMAN, A., Cyclic cohomology of algebras of smooth functions on orbifolds, *London Math. Soc. Lect. Ser.* 135 (1988), 229–244. 91c:58135
- WEIBEL, C., Nil K-theory maps to cyclic homology, *Trans. AMS* 303 (1987), 541–558. 89b:18014
- WEINBERGER, S., Aspects of the Novikov conjecture, *Contemp. Math.* 105 (1990), 281–297.
- WEYL, H., The classical groups, Princeton University Press, 1946.
- WHITEHEAD, G.W., Elements of homotopy theory, *Graduate Text in Math.* 61, Springer, 1978.
- WIGNER, D., An identity in the free Lie algebra, *Proc. Amer. Math. Soc.* 106 (1989), 639–640. 90b:17029

- WODZICKI, M., Cyclic homology of differential operators, *Duke Math. J.* 54 (1987), 641–647. 88k:32035
- WODZICKI, M., Vanishing of cyclic homology of stable C^* -algebras, *C. R. Acad. Sci. Paris Sér. A-B* 307 (1988), 327–334. 89j:46069
- WODZICKI, M., The long exact sequence in cyclic homology associated with an extension of algebras, *C. R. Acad. Sci. Paris Sér. A-B* 306 (1988), 399–403. 89i:18012
- WODZICKI, M., Cyclic homology of differential operators in characteristic $p > 0$, *C. R. Acad. Sci. Paris Sér. A-B* 307 (1988), 249–254. 89i:14015
- WODZICKI, M., Cyclic homology of pseudodifferential operators and noncommutative Euler class, *C. R. Acad. Sci. Paris Sér. A-B* 306 (1988), 321–325. 89h:58189
- WODZICKI, M., Excision in cyclic homology and in rational algebraic K-theory, *Ann. Math.* 129 (1989), 591–639. 91h:19008
- WODZICKI, M., Homological properties of rings of functional analytic type, *Proc. Nat. Acad. Sci. USA* 87 (1990), 4910–4911. 91j:19011
- WODZICKI, M., Schematic cohomology of a topological space and the algebraic cyclic homology of $C(X)$, *C. R. Acad. Sci. Paris Sér. A-B* 310 (1990), 129–134. 91c:55003
- WODZICKI, M., The higher non-commutative residue and the Virasoro cocycles, preprint.
- WOLFFHARDT, K., The Hochschild homology of complete intersections, *Trans. AMS* 171 (1972), 51–66.
- WOLTERS, P., Generalized Arf invariants and reduced power operations in cyclic homology, thesis, Nijmegen, 1990.
- XIA, D.-X., Trace formulas for almost Lie group of operators and cyclic one-cocycles, *Int. Equ. Op. Theory* 9 (1986), 570–587. 88d:22015
- XIA, D.-X., Cyclic homology associated with difference operators and anticommutators, *Integral Equations Operator Theory* 10 (1987), 739–750. 89g:47045
- XIA, D.-X., A note on the cyclic cohomology and K-theory associated with difference operators, *Rocky Mountain J. Math.* 20 (1990), 637–650. 91i:46086
- XIA, D.-X., Trace formulas for almost commuting operators, cyclic cohomology and subnormal operators, *Integral Equations Operator Theory* 14 (1991), 276–298. 89h:17017
- ZAMBONI, L.Q., A Chern character in cyclic homology, *Trans. AMS* 331 (1992) 157–163.
- ZEKRI, R., Thom elements and bivariant cyclic homology, *K-theory* 6 (1992), 335–346.

References 1992-1996

- ABOUGHAZI, R., OGLE, C., On Chevalley-Eilenberg and cyclic homologies. *J. Algebra* 166 (1994), 317-339.
- ANDRZEJEWSKI, W., TRALLE, A., Cohomology of some graded differential algebras. *Fund. Math.* 145 (1994), 181-204.
- BACH, Cyclic homology of hypersurfaces. *J. Pure Appl. Algebra* 83(1992), 205-218.
- BACH, Cyclic homology of monogenic algebras. *Comm. Algebra* 22 (1994), 4899-4904.
- BAUM, P., HIGSON, N., PLYMEN, R., Equivariant homology for $SL(2)$ of a p -adic field. Index theory and operator algebras (Boulder, CO, 1991), 1-18, *Contemp. Math.*, 148, Amer. Math. Soc., Providence, RI, 1993.
- BELLA BACI, A., La différentielle de la suite spectrale de Feïgin-Tsygan-Nistor. *C. R. Acad. Sci. Paris Sér. I Math.* 315 (1992), 531-536.
- BERMAN, S., GAO, Y., KRYLYUK, Y.S., Quantum tori and the structure of elliptic quasi-simple Lie algebras. *J. Funct. Anal.* 135 (1996), 339-389.
- BLACKADAR, B., CUNTZ, J., Differential Banach algebra norms and smooth subalgebras of C^* -algebras. *J. Operator Theory* 26 (1991), 255-282.
- BLANC, P., BRYLINSKI, J.-L., Cyclic homology and the Selberg principle. *J. Funct. Anal.* 109 (1992), 289-330.
- BLOCK, J., GETZLER, E., Equivariant cyclic homology and equivariant differential forms. *Ann. Sci. École Norm. Sup. (4)* 27 (1994), 493-527.
- BLOCK, J., GETZLER, E., JONES, J. D. S., The cyclic homology of crossed product algebras. II. Topological algebras. *J. Reine Angew. Math.* 466 (1995), 19-25.
- BÖDIGHEIMER, C.-F., Cyclic homology and moduli spaces of Riemann surfaces. K -theory (Strasbourg, 1992). *Astérisque No. 226* (1994), 43-55.
- BÖKSTEDT, M., MADSEN, I., Topological cyclic homology of the integers. K -theory (Strasbourg, 1992). *Astérisque No. 226* (1994), 57-143.
- BÖKSTEDT, M., HSIANG, W. C., MADSEN, I., The cyclotomic trace and algebraic K -theory of spaces. *Invent. Math.* 111 (1993), 465-539.
- BRODZKI, J., Binomial identities in the Cuntz algebra of complex numbers. *Exposition. Math.* 12 (1994), 463-471.
- BRODZKI, J., Derivations, semidirect products and reduced cyclic cohomology. *J. Reine Angew. Math.* 436 (1993), 177-195.
- BRODZKI, J., Simplicial normalization in the entire cyclic cohomology of Banach algebras. *K-Theory* 9 (1995), 353-377.
- BRODZKI, J., The GNS algebra and Fredholm modules. *Comm. Algebra* 23 (1995), 1527-1543.
- BRYLINSKI, J.-L., NISTOR, V., Cyclic cohomology of étale groupoids. *K-Theory* 8 (1994), 341-365.
- BRYLINSKI, J.-L., The degeneracy of two spectral sequences. *The Gelfand Mathematical Seminars, 1990-1992*, 1-10, Birkhäuser Boston, Boston, MA, 1993.

- CATHELINÉAU, J.-L., Homologie du groupe linéaire et polylogarithmes (d'après A. B. Goncharov et d'autres). Séminaire Bourbaki, Exp. No. 772, *Astérisque No. 216* (1993), 311-341.
- CENKL, B., VIGUÉ-POIRRIER, M., The cyclic homology of $P(G)$. The Proceedings of the Winter School Geometry and Topology (Srni, 1992). *Rend. Circ. Mat. Palermo (2) Suppl. No. 32* (1993), 195-199.
- CENKL, B., VIGUÉ-POIRRIER, M., Hochschild and cyclic homology of an almost commutative cochain algebra associated to a nilmanifold. Algebraic topology: new trends in localization and periodicity (Sant Feliu de Guixols, 1994), 69-93, *Progr. Math.*, 136, Birkhäuser, Basel, 1996.
- CONNES, A., FLATO, M., STERNHEIMER, D., Closed star products and cyclic cohomology. *Lett. Math. Phys.* 24 (1992), 1-12.
- CONNES, A., Geometry from the spectral point of view. *Lett. Math. Phys.* 34 (1995), 203-238.
- CONNES, A., MOSCOVICI, H., The local index formula in noncommutative geometry. *Geom. Funct. Anal.* 5 (1995), 174-243.
- CONNES, A., MOSCOVICI, H., Transgression and the Chern character of finite-dimensional K -cycles. *Comm. Math. Phys.* 155 (1993), 103-122.
- CONNES, A., Noncommutative geometry. *Academic Press, Inc.*, San Diego, CA, 1994.
- CONNES, A., SULLIVAN, D., TELEMAN, N., Formules locales pour les classes de Pontrjagin topologiques. *C. R. Acad. Sci. Paris Sér. I Math.* 317 (1993), 521-526.
- COQUEREAUX, R., RAGOUCY, E., Currents on Grassmann algebras. *J. Geom. Phys.* 15 (1995), 333-352.
- CORNICK, J., On the homology of group graded algebras. *J. Algebra* 174 (1995), 999-1023.
- CORTIÑAS, G., L -theory and dihedral homology. *Math. Scand.* 73 (1993), 21-35.
- CORTIÑAS, G., GUCCIONE, J.A., GUCCIONE, J.J., Decomposition of the Hochschild and cyclic homology of commutative differential graded algebras. *J. Pure Appl. Algebra* 83 (1992), 219-235.
- CORTIÑAS, G., SHAPIRO, J.M., Central extension of quadratic Lie algebras and its relation to dihedral homology. *J. Algebra* 180 (1996), 725-756.
- CUNTZ, J., A survey of some aspects of noncommutative geometry. Jahresber. *Deutsch. Math.-Verein.* 95 (1993), 60-84.
- CUNTZ, J., Quantized differential forms in noncommutative topology and geometry. Representation theory of groups and algebras, 65-78, *Contemp. Math.*, 145, *Amer. Math. Soc.*, Providence, RI, 1993.
- CUNTZ, J., QUILLEN, D., Cyclic homology and nonsingularity. *J. Amer. Math. Soc.* 8 (1995), 373-442.
- CUNTZ, J., QUILLEN, D., On excision in periodic cyclic cohomology. II. The general case. *C. R. Acad. Sci. Paris Sér. I Math.* 318 (1994), 11-12.
- CUNTZ, J., QUILLEN, D., On excision in periodic cyclic cohomology. *C. R. Acad. Sci. Paris Sér. I Math.* 317 (1993), 917-922.
- CUNTZ, J., QUILLEN, D., Operators on noncommutative differential forms and cyclic homology. Geometry, topology, & physics, 77-111, *Conf. Proc. Lecture Notes Geom. Topology*, VI, *Internat. Press, Cambridge, MA*, 1995.
- CUNTZ, J., Representations of quantized differential forms in non-commutative geometry. *Mathematical physics*, X (Leipzig, 1991), 237-251, *Springer, Berlin*, 1992.
- DAHL, E., Cohomologie cyclique des produits croisés tordus. *Math. Scand.* 78 (1996), 255-265.

- DAYTON, B. H., WEIBEL, C. A., Module structures on the Hochschild and cyclic homology of graded rings. Algebraic K -theory and algebraic topology (Lake Louise, AB, 1991), 63–90, *NATO Adv. Sci. Inst. Ser. C Math. Phys. Sci.*, 407, *Kluwer Acad. Publ., Dordrecht*, 1993.
- EMMANOUIL, I., Cyclic homology and de Rham homology of commutative algebras. *C. R. Acad. Sci. Paris Sér. I Math.* 318 (1994), 413–417.
- EMMANOUIL, I., On the excision theorem in bivariant periodic cyclic cohomology. *C. R. Acad. Sci. Paris Sér. I Math.* 323 (1996), 229–233.
- EMMANOUIL, I., The cyclic homology of affine algebras. *Invent. Math.* 121 (1995), 1–19.
- EMMANOUIL, I., The Künneth formula in periodic cyclic homology. *K-Theory* 10 (1996), 197–214.
- EMMANOUIL, I., The periodic cyclic cohomology of a tensor product. *C. R. Acad. Sci. Paris Sér. I Math.* 320 (1995), 263–267.
- FARSI, C., A note on K -theoretical index theorems for orbifolds. *Proc. Roy. Soc. London Ser. A* 437 (1992), no. 1900, 429–431.
- FILLMORE, P., KHALKHALI, M., Entire cyclic cohomology of Banach algebras. Nonselfadjoint operators and related topics (Beer Sheva, 1992), 256–263, *Oper. Theory Adv. Appl.*, 73, *Birkhäuser, Basel*, 1994.
- FLATO, M., STERNHEIMER, D., Closedness of star products and cohomologies. Lie theory and geometry, 241–259, *Progr. Math.*, 123, *Birkhäuser Boston*, Boston, MA, 1994.
- FLATO, M., STERNHEIMER, D., Quantum groups, star products and cyclic cohomology. Quantum and non-commutative analysis (Kyoto, 1992), 221–237, *Math. Phys. Stud.*, 16, *Kluwer Acad. Publ.*, Dordrecht, 1993.
- FLATO, M., STERNHEIMER, D., Star products, quantum groups, cyclic cohomology and pseudodifferential calculus. Mathematical aspects of conformal and topological field theories and quantum groups (South Hadley, MA, 1992), 53–72, *Contemp. Math.*, 175, *Amer. Math. Soc., Providence, RI*, 1994.
- FLATO, M., STERNHEIMER, D., Topological quantum groups, star products and their relations. *Algebra i Analiz* 6 (1994), 242–251.
- FRABETTI, A., Leibniz homology of dialgebras of matrices. *J. Pure Appl. Algebra*, (1997),
- GAUCHER, P., Produit tensoriel de matrices, homologie cyclique, homologie des algèbres de Lie. *Ann. Inst. Fourier (Grenoble)* 44 (1994), 413–431.
- GELLER, S. C., WEIBEL, C. A., Hodge decompositions of Loday symbols in K -theory and cyclic homology. *K-Theory* 8 (1994), 587–632.
- GETZLER, E., Cartan homotopy formulas and the Gauss-Manin connection in cyclic homology. Quantum deformations of algebras and their representations (Ramat-Gan, 1991/1992 Rehovot, 1991/1992), 65–78, *Israel Math. Conf. Proc.*, 7, *Bar-Ilan Univ., Ramat Gan*, 1993.
- GETZLER, E., Cyclic homology and the Atiyah-Patodi-Singer index theorem. Index theory and operator algebras (Boulder, CO, 1991), 19–45, *Contemp. Math.*, 148, *Amer. Math. Soc., Providence, RI*, 1993.
- GETZLER, E., JONES, J.D.S., The cyclic homology of crossed product algebras. *J. Reine Angew. Math.* 445 (1993), 161–174.
- GETZLER, E., KAPRANOV, M.M., Cyclic operads and cyclic homology. Geometry, topology, & physics, 167–201, *Conf. Proc. Lecture Notes Geom. Topology*, VI, *Internat. Press, Cambridge, MA*, 1995.
- GETZLER, E., The odd Chern character in cyclic homology and spectral flow. *Topology* 32 (1993), 489–507.
- GNEDBAYE, A.V., On Leibniz algebra homology. *K-theory*, (1997),

- GONG, D., Excision of equivariant cyclic cohomology of topological algebras. *Michigan Math. J.* 39 (1992), 455-473.
- GONG, G., Smooth extensions for finite CW complexes. *Trans. Amer. Math. Soc.* 342 (1994), 343-358.
- GREENLEES, J.P.C., MAY, J.P., Generalized Tate cohomology. *Mem. Amer. Math. Soc.* 113 (1995).
- GROSSE, H. M., WALTER R. C., Schwinger terms and cyclic cohomology for massive $(1+1)$ -dimensional fermions and Virasoro algebras. *J. Math. Phys.* 34 (1993), 4469-4477.
- GUCCIONE, J.A., GUCCIONE, J.J., Cyclic homology of smooth algebras. *Algebra Colloq.* 2 (1995), 193-202.
- GUCCIONE, J.A., GUCCIONE, J.J., Hochschild and cyclic homology of q -difference operators. *J. Math. Kyoto Univ.* 35 (1995), 413-422.
- GUCCIONE, J.A., GUCCIONE, J. J., The theorem of excision for Hochschild and cyclic homology. *J. Pure Appl. Algebra* 106 (1996), 57-60.
- GUCCIONE, J.A., GUCCIONE, J.J., Redondo, M.J., Villamayor, O.E., Hochschild and cyclic homology of hypersurfaces. *Adv. Math.* 95 (1992), 18-60.
- GUIN, D., Cohomologie des algèbres de Lie croisées et K -théorie de Milnor additive. *Ann. Inst. Fourier (Grenoble)* 45 (1995), 93-118.
- GUMEROV, R.N., On a geometric criterion for nontriviality of the simplicial and cyclic cohomology of Banach algebras. (Russian) *Vestnik Moskov. Univ. Ser. I Mat. Mekh.* 1991, 67-69; translation in *Moscow Univ. Math. Bull.* 46 (1991), 52-53.
- GURROLA, P., Cohomologie quaternionique bivalente et caractère de Chern hermitien. *Comm. Algebra* 22 (1994), 2039-2055.
- HADDI, A., Homologie des algèbres de Lie étendues à une algèbre commutative. *Comm. Algebra* 20 (1992), 1145-1166.
- HELEMSKII, A.Ya., Banach cyclic (co)homology and the Connes-Tzygan exact sequence. *J. London Math. Soc.* (2) 46 (1992), 449-462.
- HESSELHOLT, L., A homotopy theoretical derivation of $Q\text{Map}(K, -)_+$. *Math. Scand.* 70 (1992), 193-203.
- HESSELHOLT, L., Stable topological cyclic homology is topological Hochschild homology. *K-theory (Strasbourg, 1992)*. *Astérisque No. 226* (1994), 175-192.
- HIGSON, N., NISTOR, V., Cyclic homology of totally disconnected groups acting on buildings. *J. Funct. Anal.* 141 (1996), 466-495.
- HINGSTON, N., An equivariant model for the free loop space of S^N . *Amer. J. Math.* 114 (1992), 139-155.
- HOLM, T., The Hochschild cohomology ring of a modular group algebra: the commutative case. *Comm. Algebra* 24 (1996), 1957-1969.
- HUSEMOLLER, D., Lectures on cyclic homology. Lecture notes prepared by R. Sujatha. *Tata Institute of Fundamental Research Lectures on Mathematics and Physics*, 83. Published for the Tata Institute of Fundamental Research, Bombay; by Springer-Verlag, Berlin, 1991.
- HUSEMOLLER, D., Algebraic K -theory of operator ideals (after Mariusz Wodzicki). K -theory (Strasbourg, 1992). *Astérisque No. 226* (1994), 193-209.
- HÜBL, R., A note on the Hochschild homology and cyclic homology of a topological algebra. *Manuscripta Math.* 77 (1992), 63-70.
- IGUSA, K., Cyclic homology and the determinant of the Cartan matrix. *J. Pure Appl. Algebra* 83 (1992), 101-119.
- IGUSA, K., ZACHARIA, D., On the cyclic homology of monomial relation algebras. *J. Algebra* 151 (1992), 502-521.
- INASSARIDZE, H., Algebraic K -theory. Mathematics and its Applications, 311. *Kluwer Academic Publishers Group, Dordrecht*, 1995.

- JAFFE, A., Noncommutative geometry and mathematical physics. New symmetry principles in quantum field theory (Cargèse, 1991), 295–308, *NATO Adv. Sci. Inst. Ser. B Phys.*, 295, Plenum, New York, 1992.
- JI, R., Module structures on Hochschild and cyclic cohomology of crossed products. *Algebraic methods in operator theory*, 236–260, Birkhäuser Boston, Boston, MA, 1994.
- JI, R., Trace invariant and cyclic cohomology of twisted group C^* -algebras. *J. Funct. Anal.* 130 (1995), 283–292.
- JI, R., A module structure on cyclic cohomology of group graded algebras. *K-Theory* 7 (1993), 369–399.
- JI, R., Nilpotency of Connes' periodicity operator and the idempotent conjectures. *K-Theory* 9 (1995), 59–76.
- JI, R., Smooth dense subalgebras of reduced group C^* -algebras, Schwartz cohomology of groups, and cyclic cohomology. *J. Funct. Anal.* 107 (1992), 1–33.
- JI, R., Some applications of cyclic cohomology to the study of group C^* -algebras. Index theory and operator algebras (Boulder, CO, 1991), 121–129, *Contemp. Math.*, 148, Amer. Math. Soc., Providence, RI, 1993.
- KADISON, L., KASTLER, D., Cohomological aspects and relative separability of finite Jones index subfactors. *Nachr. Akad. Wiss. Göttingen Math.-Phys. Kl. II* 1992, 11 pp.
- KASSEL, C., A Künneth formula for the decomposition of the cyclic homology of commutative algebras. *Math. Scand.* 70 (1992), 27–33.
- KASSEL, C., Cyclic homology of differential operators, the Virasoro algebra and a q -analogue. *Comm. Math. Phys.* 146 (1992), 343–356.
- KASSEL, C., VIGUÉ-POIRRIER, M., Homologie des quotients primitifs de l'algèbre enveloppante de $sl(2)$. *Math. Ann.* 294 (1992), 483–502.
- KASTLER, D., KMS states, cyclic cohomology and supersymmetry. Quantum groups (Clausthal, 1989), 375–397, *Lecture Notes in Phys.*, 370, Springer, Berlin, 1990.
- KASTLER, D., Cyclic cohomology, supersymmetry and KMS states: the KMS states as generalized elliptic operators. Differential geometric methods in theoretical physics (Davis, CA, 1988), 105–116, *NATO Adv. Sci. Inst. Ser. B Phys.*, 245, Plenum, New York, 1990.
- KELLER, B., Invariance of cyclic homology under derived equivalence. Representation theory of algebras (Cocoyoc, 1994), 353–361, *CMS Conf. Proc.*, 18, Amer. Math. Soc., Providence, RI, 1996.
- KHALKHALI, M., A vanishing theorem for operations on entire cyclic cohomology. *K-Theory* 8 (1994), 435–442.
- KHALKHALI, M., Algebraic connections, universal bimodules and entire cyclic cohomology. *Comm. Math. Phys.* 161 (1994), 433–446.
- KHALKHALI, M., An approach to operations on cyclic homology. *J. Pure Appl. Algebra* 107 (1996), 47–59.
- KHALKHALI, M., Nilpotent extensions and entire cyclic cohomology. *K-Theory* 8 (1994), 429–434.
- KHALKHALI, M., On the entire cyclic cohomology of Banach algebras. *Comm. Algebra* 22 (1994), 5861–5874.
- KHELEMSKIĬ, A. Ya., Banach cyclic (co)homology as Banach derived functors. (Russian) *Algebra i Analiz* 3 (1991), 213–228; translation in *St. Petersburg Math. J.* 3 (1992), 1149–1164.
- KLIMEK, S., LESNIEWSKI, A., A note on the entire cyclic cohomology of a finite-dimensional noncommutative space. *Canad. Math. Bull.* 36 (1993), 449–457.

- LAMBE, L., LÖFWALL, C., The cohomology ring of the free loop space of a wedge of spheres and cyclic homology. *C. R. Acad. Sci. Paris Sér. I Math.* 320 (1995), 1237–1242.
- LAMBRE, T., Quelques exemples de lemmes de première perturbation en homologie cyclique. *Comm. Algebra* 23 (1995), 525–541.
- LARSEN M., Homology of maximal orders in central simple algebras. *Comment. Math. Helv.* 67 (1992), 613–634.
- LARSEN, M., Filtrations, mixed complexes, and cyclic homology in mixed characteristic. *K-Theory* 9 (1995), 173–198.
- LARSEN, M., LINDENSTRAUSS, A., Cyclic homology of Dedekind domains. *K-Theory* 6 (1992), 301–334.
- LESNIEWSKI, A., OSTERWALDER, K., Superspace formulation of the Chern character of a theta-summable Fredholm module. *Comm. Math. Phys.* 168 (1995), 643–650.
- LODAY, J.-L., Une version non commutative des algèbres de Lie: les algèbres de Leibniz. *Enseign. Math. (2)* 39 (1993), 269–293.
- LODAY, J.-L., Cup-product for Leibniz cohomology and dual Leibniz algebras. *Math. Scand.* 77 (1995), 189–196.
- LODAY, J.-L., Künneth-style formula for the homology of Leibniz algebras. *Math. Zeit.* 221 (1996), 41–47.
- LODAY, J.-L., PIRASHVILI, T., Universal enveloping algebras of Leibniz algebras and (co)homology. *Math. Ann.* 296 (1993), 139–158.
- LODDER, J.M., Dihedral homology and homotopy fixed point sets. Algebraic topology (Oaxtepec, 1991), 215–224, *Contemp. Math.*, 146, *Amer. Math. Soc., Providence, RI*, 1993.
- LODDER, J.M., Leibniz homology and the James model. *Math. Nachr.* 175 (1995), 209–229.
- LODDER, J.M., Leibniz homology and the Hilton-Milnor theorem, *Topology* 36 (1997), 729–743.
- LORENZ, M., Crossed products: characters, cyclic homology, and Grothendieck groups. *Noncommutative rings* (Berkeley, CA, 1989), 69–98, *Math. Sci. Res. Inst. Publ.*, 24, *Springer, New York*, 1992.
- LORENZ, M., On Galois descent for Hochschild and cyclic homology. *Comment. Math. Helv.* 69 (1994), 474–482.
- LORENZ, M., On the homology of graded algebras. *Comm. Algebra* 20 (1992), 489–507.
- LOTT, J., Superconnections and higher index theory. *Geom. Funct. Anal.* 2 (1992), 421–454.
- LOTT, J., Higher eta-invariants. *K-Theory* 6 (1992), 191–233.
- MADSEN, I., The cyclotomic trace in algebraic K -theory. First European Congress of Mathematics, Vol. II (Paris, 1992), 213–241, *Progr. Math.*, 120, *Birkhäuser, Basel*, 1994.
- MASUDA, T., WATANABE, J., Quantum groups as objects of noncommutative geometry. Current topics in operator algebras (Nara, 1990), 359–370, *World Sci. Publishing, River Edge, NJ*, 1991.
- MCCARTHY, R., On operations for Hochschild homology, *Comm. Alg.* 21 (1993), 2947–2965.
- MCCARTHY, R., The cyclic homology of an exact category. *J. Pure Appl. Algebra* 93 (1994), 251–296.
- MELNİKOV, S.S., Dihedral Banach cohomology. (Russian) *Uspekhi Mat. Nauk* 48 (1993), no. 6(294), 161–162.
- MICHLER, R.I., Hodge-components of cyclic homology for affine quasi-homogeneous hypersurfaces. *K-theory (Strasbourg, 1992)*. *Astérisque No.* 226 (1994), 321–333.

- MISHCHENKO, A.S., PIDSTRIGACH, V. YA., Cohomological trace of differential operators with parameters. (Russian) *Trudy Mat. Inst. Steklov.* 193 (1992), 142–146 translation in *Proc. Steklov Inst. Math.* 1993, 155–159.
- MORIYOSHI, H., Cyclic cohomology and graph projections. Geometry and its applications (Yokohama, 1991), 135–145, *World Sci. Publishing, River Edge, NJ*, 1993.
- MORIYOSHI, H., On cyclic cocycles associated with the Godbillon-Vey classes. Geometric study of foliations (Tokyo, 1993), 411–423, *World Sci. Publishing, River Edge, NJ*, 1994.
- MOSCOVICI, H., WU, F., Index theory without symbols. C^* -algebras: 1943–1993 (San Antonio, TX, 1993), 304–351, *Contemp. Math.*, 167, *Amer. Math. Soc., Providence, RI*, 1994.
- MOSCOVICI, H., WU, F., Localization of topological Pontrjagin classes via finite propagation speed. *C. R. Acad. Sci. Paris Sér. I Math.* 317 (1993), 661–665.
- NATSUME, T., NEST, R., The local structure of the cyclic cohomology of Heisenberg Lie groups. *J. Funct. Anal.* 119 (1994), 481–498.
- NEST, R., TSYGAN, B., Algebraic index theorem. *Comm. Math. Phys.* 172 (1995), 223–262.
- NISTOR, V., A bivariant Chern-Connes character. *Ann. of Math. (2)* 138 (1993), 555–590.
- NISTOR, V., Cyclic cohomology of crossed products by algebraic groups. *Invent. Math.* 112 (1993), 615–638.
- NISTOR, V., Higher McKean-Singer index formulae and noncommutative geometry. Representation theory of groups and algebras, 439–452, *Contemp. Math.*, 145, *Amer. Math. Soc., Providence, RI*, 1993.
- NUSS, P., Décomposition de la cohomologie cyclique bivariable des algèbres commutatives. *Math. Scand.* 70 (1992), 5–26.
- NUSS, P., Hochschild homology and cyclic homology of almost commutative algebras. Second International Conference on Algebra (Barnaul, 1991), 317–325, *Contemp. Math.*, 184, *Amer. Math. Soc., Providence, RI*, 1995.
- OUDOM, J.-M., La diagonale en homologie des algèbres de Leibniz. *C.R. Acad. Sci. Paris, t. 320, Série I* (1995), 1165–1170.
- OUDOM, J.-M., Coproduct and cogroups in the category of graded dual Leibniz algebras. *Contemporary Mathematics 202 : Operads, Proceedings of Renaissance Conferences*, (1997), 115–135.
- OGLE, C., Assembly maps, K -theory, and hyperbolic groups. *K-Theory* 6 (1992), 235–265.
- PENKAVA, M., SCHWARZ, A., A_∞ algebras and the cohomology of moduli spaces. Lie groups and Lie algebras: E. B. Dynkin's Seminar, 91–107, *Amer. Math. Soc. Transl. Ser. 2*, 169, *Amer. Math. Soc., Providence, RI*, 1995.
- PIRASHVILI, T., On Leibniz homology. *Ann. Inst. Fourier* 44 (1994), 401–411.
- PIRASHVILI, T., On the topological Hochschild homology of $\mathbf{Z}/p^k\mathbf{Z}$. *Comm. Algebra* 23 (1995), 1545–1549.
- QUILLEN, D., Bivariant cyclic cohomology and models for cyclic homology types. *J. Pure Appl. Algebra* 101 (1995), 1–33.
- RODICIO, A.G., On the rigidity of the generalized Koszul complexes with applications to Hochschild homology. *J. Algebra* 167 (1994), 343–347.
- ROE, J., Coarse cohomology and index theory on complete Riemannian manifolds. *Mem. Amer. Math. Soc.* 104 (1993).
- RONCO, MARIA, On the Hochschild homology decompositions. *Comm. Algebra* 21 (1993), 4699–4712.
- ROSENBERG, J., Algebraic K -theory and its applications. Graduate Texts in Mathematics, 147. *Springer-Verlag, New York*, 1994.

- SAVO, AL., Homology of the quantum plane and the twisted de Rham complex. Differential geometry and topology applications in physics and technics (Bucharest, 1991). *Polytech. Inst. Bucharest Sci. Bull. Electr. Engrg.* 53 (1991), no. 3-4, 301-310.
- SCHAFFER, J.A., Relative cyclic homology and the Bass conjecture. *Comment. Math. Helv.* 67 (1992), 214-225.
- SCHNEIDER, P., The cyclic homology of p -adic reductive groups. *J. Reine Angew. Math.* 475 (1996), 39-54.
- SOLOTAR, A., Bivariant cohomology and S^1 -spaces. *Bull. Soc. Math. France* 120 (1992), 397-412.
- SOLOTAR, A., Cyclic homology of a free loop space. *Comm. Algebra* 21 (1993), 575-582.
- SOLOTAR, A., Vigué-Poirrier, M. Dihedral homology of commutative algebras. *J. Pure Appl. Algebra* 109 (1996), 97-106.
- SONG, Y., Relative Hermitian algebraic K -theory and dihedral homology. *K-Theory* 5 (1991/92), 503-529.
- STEFFAN, J.-L., Equivalence de Morita relative. *Comm. Algebra* 20 (1992), 3609-3647.
- TILLMANN, U., K -theory of fine topological algebras, Chern character, and assembly. *K-Theory* 6 (1992), 57-86.
- TILLMANN, U., Factorization of the (relative) Chern character through Lie algebra homology. *K-Theory* 6 (1992), 457-463.
- TILLMANN, U., Relation of the van Est spectral sequence to K -theory and cyclic homology. *Illinois J. Math.* 37 (1993), 589-608.
- TRALLE, A.E., On Hochschild and cyclic homology of certain homogeneous spaces. *Czechoslovak Math. J.* 43(118) (1993), 615-634.
- TROITSKII, E V., Traces, C^* -elliptic complexes, and higher-dimension even cyclic homology. (Russian) *Vestnik Moskov. Univ. Ser. I Mat. Mekh.* 1993, 36-39, 88 translation in *Moscow Univ. Math. Bull.* 48 (1993), 34-38.
- VAN DEN BERGH, M., Noncommutative homology of some three-dimensional quantum spaces. Proceedings of Conference on Algebraic Geometry and Ring Theory in honor of Michael Artin, Part III (Antwerp, 1992). *K-Theory* 8 (1994), 213-230.
- VIGNÉRAS, M-F., Homologie cyclique, principe de Selberg et pseudo-coefficient. *Invent. Math.* 116 (1994), 651-676.
- VIGUÉ-POIRRIER, M., Critères de nullité pour l'homologie des algèbres graduées. *C. R. Acad. Sci. Paris Sér. I Math.* 317 (1993), 647-649.
- VIGUÉ-POIRRIER, M., Homologie cyclique des espaces formels. *J. Pure Appl. Algebra* 91 (1994), 347-354.
- VIGUÉ-POIRRIER, M., Homologie et K -théorie des algèbres commutatives: caractérisation des intersections complètes. *J. Algebra* 173 (1995), 679-695.
- WAMBST, M., Complexes de Koszul quantiques et homologie cyclique. *C. R. Acad. Sci. Paris Sér. I Math.* 314 (1992), 977-982.
- WAMBST, M., Complexes de Koszul quantiques. *Ann. Inst. Fourier (Grenoble)* 43 (1993), 1089-1156.
- WAMBST, M., Hochschild and cyclic homology of the quantum multiparametric torus. *J. Pure Appl. Algebra* 114 (1997), 321-329.
- WANG, X., A bivariant Chern character. II. *Canad. J. Math.* 44 (1992), 400-435.
- WEIBEL, C., An introduction to homological algebra. Cambridge Studies in Advanced Mathematics, 38. Cambridge University Press, Cambridge, 1994.
- WEIBEL, C., Cyclic homology for schemes. *Proc. Amer. Math. Soc.* 124 (1996), 1655-1662.
- WEIBEL, C., Le caractère de Chern en homologie cyclique périodique. *C. R. Acad. Sci. Paris Sér. I Math.* 317 (1993), 867-871.

- XIA, D., A note on the trace formulas for almost commuting operators. *Proc. Amer. Math. Soc.* 116 (1992), 135–141.
- XIA, D., Generalized cyclic cohomology associated with deformed commutators. *Proc. Amer. Math. Soc.* 124 (1996), 1743–1753.
- YU, G.L., Cyclic cohomology and higher indices for noncompact complete manifolds. *J. Funct. Anal.* 133 (1995), 442–473.
- ZAMBONI, L.Q., On the invariance of conjugation in cyclic homology. *Riv. Mat. Univ. Parma (5)* 1 (1992), 295–304 (1993).
- ZEKRI, R., Thom elements and bivariant cyclic cohomology. *K-Theory* 6 (1992), 335–346.

Symbols

(A, d) or (A, δ)	5.3.1, A.8	Δ	B.1
$\bar{A} = A/k$	1.1.14, 2.1.9	D	1.3, 4.1.4
$a(\sigma)$	before 9.3.8	d	1.3.8, 2.3.1 (or see below)
A_+ or I_+	1.4.0	δ (also denoted d in Chap. 10),	1.3.4, 3.3.1
$ad(u)$	1.3.2	$\mathcal{D}(A)$	2.3.6
AL_n	9.3.8	d^2	D.2
\mathcal{A}_θ	5.6.5	da	1.1.9
$A^{\otimes n}$	1.1.1	$\Delta C, \Delta S$	6.1
$\mathcal{B}(A)$	2.1.7	$\text{Der}(A)$	1.3.1, 1.5.2
$\bar{\mathcal{B}}(A)$	2.1.9	$\Delta G,$	6.3.0
B_*	2.1.7.4, 2.3.4	$DG-$	5.3.1
B	2.1.7, 2.5.10, 10.6.14	d_i	1.1.1, 6.1.2, B.4
b	1.1.1, 2.5.5	Δ^n	B.6
b'	1.1.11, 2.5.5	D_n	5.2.5, 6.3
$b^{[2]}$	2.2.6	$\Delta[p]$	B.7
\mathcal{BC}	2.5.10	$E(A)$	11.1.4
$\mathcal{BC}(A, \delta)$	5.3.3	$e^{(i)}$	4.5.2
$\mathcal{BC}^-, \mathcal{BC}^{\text{per}}$	5.1.7	E_{pq}^2	D.1
$BG, B.G$	B.12.Ex.1	e_D, E_D	4.1.7
$B.(G, z)$	7.3.3	EG	B.12.Ex.1
$C(A), C_n(A)$	1.1.3	$E_{ij}(a)$	1.1.7
$\bar{C}_n(A)$	1.1.14	$e_{ij}(a)$	11.1.4
$C_n(G, M)$	C.2	$e_n^{(i)}$	4.5.2, 4.5.5
$C_*(\mathfrak{g}, V)$	10.1.3	ε_n	1.3.4, 1.3.12
$C.$	6.1.10, 7.1.2, 7.3.2	F (adjoint functor)	7.1.5
$CC(A)$	2.1.2	$F(R)$	13.1.1
$CC^{\{2\}}$	1.4.5, 2.2.1	$\mathcal{F}(R)$	13.1.1
CC^-, CC^{per}	5.1.1	Fin, Fin'	6.4.1
CDG	5.4.1, A.8	\mathfrak{g}	3.3.0
ch	8.1.7	" G "	B.12.Ex.1
ch_0	8.2.4	$GL_n(A), GL(A)$	11.1.1
ch^-	8.3.8, 8.4.4	$gl_r(A), gl(A)$	10.2.1
$C_n^\lambda(A)$	2.1.4	G_z	7.4.3
$C_n(A, M)$	1.1.1	$H_*(\mathfrak{g}), H_*(\mathfrak{g}, V)$	10.1.4
$C^n(A, M)$	1.5.1	H^+, H^-	5.2.3
cotr	1.5.6		
$C^{\text{sym}}(A)$	6.1.12		

- H_*^{bar} 1.4.3
 HC_ε 5.6.8
 $HC_n(A), HC_*(A)$ 2.1.3
 $HC^n(A)$ 2.4.1
 $HC_n(A, I)$ 2.1.15
 $HC_n(A|k), HC_n^k(A)$ 2.1.16
 HC^{per}, HC^- 5.1.3
 HD, HD' 5.2.7
 $HDR_n(A)$ 2.6.6
 $HH_n(A)$ 1.1.4
 $HH^n(A)$ 1.5.5
 $HH_n(A|k)$ 1.1.18
 HL_* 10.6.4
 HML 13.2.8
 $H_n^\lambda(A)$ 2.1.4
 $H_n(A, M)$ 1.1.3
 $H^n(A, M),$ 1.5.1,
 $H_\lambda^n(A)$ 2.4.2
 HQ 5.2.13
 H^{S^1} 7.2.1
- I (map) 2.2.1
 $I_{n,r}$ 9.2.6
 $\text{Indec},$ A.3
- $J_{n,r}$ 9.1.3
- K_0 8.2.2
 K_1 11.1.1
 K_2 11.1.10
 K_3 11.2.7
 K_*^s 13.3.1
 $k[\varepsilon]$ 1.1.6
 $k[G]$ Notation and terminology 7.4
 K_n 11.2.4
 K_n^M 11.1.16
 $K_n(A, I)$ 11.2.19
 $K_n(A; I, J)$ 11.2.20
 $K_n^+(A)$ remark after 10.2.4
- $L(A)$ 10.6.7
 $\Lambda(V), \Lambda(\mathfrak{g})$ 10.1.3, A.1
 L_D 4.1.4
 $l_n^{k,0}, l_n^{k,1}$ 4.6.1
 $\lambda_n^k, \bar{\lambda}_n^k, l_n^k$ 4.5.5
 $\mathcal{LX}, \mathcal{LBG}$ 7.3
- $\mathcal{M}_r(A)$ 1.1.6, 1.2.0
 N 2.1.0, 2.5.5
 o_r 10.5.2
 $Pf(\alpha)$ 9.5.13
 $Q_*(A)$ 13.2.2
 $S(V)$ 3.2.1, A.1
 S (map) 2.2.1, 2.2.5, 2.5.8
 sh 4.2.8
 $SK_1(A)$ 11.1.2
 S_n Notation and Terminology
 $S0$ 13.3.7
 sp_r 10.5.3
 $St(A)$ 11.1.7
 $st(A)$ E.10.2.5
- T (trace map) 9.2
 T (twisting map) 4.4.2, A.2
 $T(V), T(\mathfrak{g})$ 3.1.1, 10.6.3, A.1
 t, t_n 2.1.0, 2.5.1, 6.1.2, 10.6.13
 T^γ 11.2.13
 t^γ 11.3.10
 $Tot C$ 1.0.11
 $Tot T$ 5.1.2
 tr, Tr 1.1.7
 θ_* 10.2.3
- u, v 2.1.12, 4.4.6, 5.1.4
 $U(\mathfrak{g})$ 3.3.1, 10.1.2
- $X(A)$ 11.2.13
 $x(A)$ 11.3.10
 $X(A, I)$ 11.3.3
 $x(A, I)$ 11.3.10
 $X(G, z)$ 7.3.5
 $|x|$ 1.0.1
 $|X|$ B.7, B.8
 $|X|^{\text{cy}}$ 7.2.2
 $\langle z \rangle, \langle G \rangle$ 7.4.3
 $\Omega_{A|k}^1, \Omega_{A|k}^n$ 1.1.9, 1.3.8, 1.3.11
 $\hat{\otimes}$ 5.1.7
 $\hat{\otimes}_\pi,$ 5.6.2
 $[-, -]$ 1.1.6, 10.1.1, 11.1.1
 $\langle -, - \rangle$ 1.5.9, 2.4.7, E.11.1.1

Index

- Acyclic 1.0.4
- Additive K -theory remark after 10.2.4
- Adjoint representation 10.4.1
- Adjunction formula 1.5.10
- Alexander-Whitney 1.6.9
- Almost symmetric algebra 3.3.8
- Amitsur-Levitzki 9.3.7, 10.3.10
- Antisymmetrization map 1.3.4, 1.3.12
- André-Quillen homology 3.5, App. E.4
- Assembly map 12.3.9, 12.4.1

- Bar complex, bar resolution 1.1.11
- Bass trace conjecture 8.5.2
- Beilinson-Loday symbol, E.11.2.3
- Bicomplex 1.0.11, App. D.1
- Bicomplex of truncated de Rham complexes 2.3.6
- Bimodule 1.1.0
- Birelative cyclic homology E.2.1.2
- Birelative Hochschild homology E.1.1.6
- Bisimplicial objects App. B.15
- Bivariant 5.5
- Borel construction 7.2.1
- Boundary map 1.0.1, 1.0.5
- Bousfield-Kan construction App. B.13
- Braid group E.6.3.1

- Campbell-Hausdorff formula E.4.5.5
- Cartan-Milnor-Moore theorem App. A.10
- Cayley-Hamilton 9.3
- Character of a cycle 2.4.7
- Chern character Chap. 8, 11.4, 11.5
- Chern-Connes pairing 8.4.13
- Chevalley-Eilenberg (CE-) complex (or map) 1.3.4, 3.3.1, 10.1.3

- Classifying space App. B.12
- Coalgebra App. A.2
- Commutator 1.1.6, 11.1.1
- Comodule structure 2.5.17
- Complex, chain-complex 1.0.1
- Composition product 5.5.5
- Concatenation App. A.1
- Conjugation 4.1.1
- Connection 8.1.1
- Connes boundary map 2.1.7, 2.5.10
- Connes complex 2.1.4, 2.5.9
- Connes cyclic category 6.1
- Connes exact sequence 2.2.1, 2.5.8
- Cosimplicial App. B.4
- Cotrace map 1.5.6
- cross-effect E.13.1.2
- Crossed module E.10.1.3, App. C.8
- Crossed simplicial group 6.3.0
- Cyclic bar complex 1.1.3
- Cyclic bar construction 7.3.10
- Cyclic bicomplex 2.1.2, 2.5.5
- Cyclic category 6.1.1
- Cyclic cohomology 2.4
- Cyclic descent 4.6.1
- Cyclic geometric realization 7.2.2
- Cyclic homology 2.1.3, 2.5.6
- Cyclic module 2.5
- Cyclic object 6.1.2
- Cyclic operator 2.1.0, 2.5.1, 6.1.2
- Cyclic set, cyclic space 6.1.2, 7.1
- Cyclic shuffle 4.3.2
- Cyclotomic trace map 12.4.2

- De Rham complex, de Rham cohomology 2.3.1
- Deconcatenation App. A.6
- Deligne complex 2.3.6
- Dennis trace map 8.4.3
- Dennis-Stein symbol E.11.1.1
- Derivation 1.3.1, 1.5.2, 4.1.4
- Descent 4.5.5

- Differential forms 1.3, 2.3
- Differential graded algebra 5.3.1, App. A.8
- Differential map 1.0.1
- Dihedral group, dihedral homology 5.2.5, 6.3, 10.5.4
- Dixmier product 13.2.7
- Dual numbers 1.1.6, E.2.2.3, E.4.2.3

- Eilenberg-Zilber 1.6.12
- Elementary matrix 1.1.7, 9.2.10, 11.1.4
- Entire cyclic cohomology 5.6.8
- Epicyclic category E.6.4.4
- Étale 3.4.1, App. E.1
- Eulerian element (number, idempotent) 4.5
- Excision 1.4.9, 2.2.17
- Exterior algebra App. A.1
- Extra degeneracy 1.1.12, 2.1.7, 2.5.7, 6.1.11–13, 10.6.12

- Foliation 5.6.6, 12.1.1
- Fredholm module 12.2.4
- Free loop space 7.3.13
- Free model 5.3.7
- functor t 13.2.4
- Fusion map 8.4.1

- Geometric realization App. B.7/B.8
- Goldbillon-Vey invariant 12.1.3
- Graded exterior product 5.4.3, App. A.1
- Grothendieck group 8.2
- Group algebra 7.4, A.4
- Gysin sequence App. D.6

- H -space App. A.11
- Harrison homology 4.2.10
- Hattori-Stallings trace map 8.5.1
- Higher algebraic K -groups 11.2.4
- Higher signature 12.3.5
- Higher symbol E.11.2.4
- HKR-theorem 3.4.4, 5.4.5
- Hochschild cohomology 1.5
- Hochschild homology (boundary, complex) 1.1
- Homology of a discrete group App. D.2
- Homology of a Lie algebra 10.1.4
- Homology of a simplicial module 1.0.7, 1.6.2, App. B.5

- Homology of a small category App. C.10
- Homotopy colimit 7.2.4, App. B.13
- Homotopy 1.0.2
- Hopf algebra E.7.4.4, App. A.2
- Hyperoctahedral 6.3.3, 9.5.1, 10.5

- Idempotent conjecture 8.5.6
- Indecomposable part App. A.3
- Index formula 12.2
- Invariant theory Chap. 9
- Involution 5.2

- Jacobi identity 10.1.1

- K -theoretic Novikov conjecture 12.4
- K -theory Chap. 11, 8.2
- Kan complex (fibration) App. B.9
- Kähler differentials 1.1.9, 1.3
- Koszul complex 3.4.6
- Koszul sign 1.0.15
- Kronecker product 1.5.9, 2.4.8
- Künneth 1.0.16, 4.3.11

- λ -decomposition 4.5, 4.6
- λ -operation 4.5.4
- L -polynomial 12.3.3
- Laurent polynomials 8.4.8
- Leibniz algebra (relation) 10.6.1
- Leray-Serre spectral sequence App. D.5
- Levi-Civita connection 8.1.8
- Lie algebra 3.3.0, 10.1.1
- Localization 1.1.17, 2.1.16

- Mac Lane (co)homology 13.1
- Mac Lane isomorphism 7.4.2
- Malcev's theory 11.3.13
- Milnor cyclic homology group 10.3.3
- Milnor K -group 11.1.16
- Milnor-Hochschild homology group 10.6.19
- Mixed complex 2.5.13
- Mixed discriminant E.9.3.2
- Morita invariance 1.2, 2.2.9

- Negative cyclic homology 5.1
- Nerve App. B.12
- Nilpotent ideal 11.3
- Non-additive bimodules 13.1.1
- Non-commutative de Rham homology 2.6.6

- Non-commutative differential forms 2.6
 Non-commutative homology of a Lie algebra 10.6.4
 Non-commutative torus 5.6.5
 Nonunital algebra 1.4, 2.2.15
 Norm map (operator) 2.1.0, 2.5.5, App. C.4
 Normalized Hochschild complex 1.1.14
 Novikov conjecture 12.3, 12.4

 Obstruction to stability 10.3.4, 10.5.10, 10.5.11, 10.6.20, 11.2.18
 Orthogonal group (matrix) 9.5, 10.5

 Periodic cyclic homology 5.1
 Periodicity exact sequence (map) 2.2.1, 2.2.8
 Perturbation Lemma E.3.1.3
 Pfaffian 9.5.13
 Plus-construction 11.2.2
 Poincaré-Birkhoff-Witt theorem 3.3.4
 Poisson algebra (bracket) 3.3.4, E.2.5.4
 Pre-simplicial 1.0.6
 Primitive part App. A.3

 Quasi-isomorphism 1.0.2
 Quaternionic 5.2, 6.3.4

 Reduced C^* -algebra 5.6.7
 Reduced cyclic homology 2.2.13
 Reduced Deligne complex 2.3.6
 Reduced Hochschild complex 1.4.2
 Regular sequence 3.4.1
 Regulator map 11.5.10
 Relative algebraic K -theory 11.2.19
 Relative cyclic homology 2.1.15
 Relative Hochschild homology 1.1.16
 Residue homomorphism 1.5.9
 Resolution 1.0.4

 S^1 -equivariant homology 7.2.1
 Schatten ideal 12.2.5
 Selberg principle E.8.5.1

 Separable algebras 1.2.12
 Shapiro's lemma App. C.9/C.12
 Shuffle 1.6.10, 4.2, App. A.5
 Signed Eulerian number E.4.6.3
 Simplex App. B.6
 Simplicial homology App. B.10
 Simplicial modules 1.6, App. B.5
 Simplicial Chap. 6, Chap. 7, App. B
 Skew-dihedral 5.2.7
 Smooth algebra 3.4.1, App. E
 Spectral sequence App. D
 Stability for the homology 10.3.2, 10.5.9, 10.6.18, 11.2.13
 Stabilization 10.2.2, 11.2.18
 stable K -theory 13.3
 Standard resolution App. C.3
 Symmetric algebra 3.2.1, App. A.1
 Symmetric group Notation and terminology
 Symplectic group (matrix) 9.5, 10.5.3

 Telescope App. B.13
 Tensor algebra 2.3, 3.1, App. A.1
 Tensor coalgebra App. A.6
 Tensor module App. A.1
 Topological algebra 5.6
 Topological tensor product 5.6.2
 Total complex 1.0.11, 5.1.2
 Trace map 1.1.7, 1.2, 2.2.8, 9.2
 Truncated de Rham complex 2.3.6
 Truncated polynomial ring E.4.1.8, 5.4.14
 Twisted Nerve 7.3.3
 Twisting map 4.4.2, App. A.2/A.8

 Universal central extension E.10.1.2, 11.1.11
 Universal enveloping algebra 3.3.1, 10.1.2

 Volodin space 11.2.13, 11.3.3

 Waldhausen S_0 -construction 13.3.7
 Weight 5.3.1, 5.4.2

 Young diagram 9.4.2

Grundlehren der mathematischen Wissenschaften

A Series of Comprehensive Studies in Mathematics

A Selection

210. Gihman/Skorohod: The Theory of Stochastic Processes I
211. Comfort/Negrepointis: The Theory of Ultrafilters
212. Switzer: Algebraic Topology – Homotopy and Homology
215. Schaefer: Banach Lattices and Positive Operators
217. Stenström: Rings of Quotients
218. Gihman/Skorohod: The Theory of Stochastic Processes II
219. Duvaut/Lions: Inequalities in Mechanics and Physics
220. Kirillov: Elements of the Theory of Representations
221. Mumford: Algebraic Geometry I: Complex Projective Varieties
222. Lang: Introduction to Modular Forms
223. Bergh/Löfström: Interpolation Spaces. An Introduction
224. Gilbarg/Trudinger: Elliptic Partial Differential Equations of Second Order
225. Schütte: Proof Theory
226. Karoubi: K-Theory. An Introduction
227. Grauert/Remmert: Theorie der Steinschen Räume
228. Segal/Kunze: Integrals and Operators
229. Hasse: Number Theory
230. Klingenberg: Lectures on Closed Geodesics
231. Lang: Elliptic Curves. Diophantine Analysis
232. Gihman/Skorohod: The Theory of Stochastic Processes III
233. Stroock/Varadhan: Multidimensional Diffusion Processes
234. Aigner: Combinatorial Theory
235. Dynkin/Yushkevich: Controlled Markov Processes
236. Grauert/Remmert: Theory of Stein Spaces
237. Köthe: Topological Vector Spaces II
238. Graham/McGehee: Essays in Commutative Harmonic Analysis
239. Elliott: Probabilistic Number Theory I
240. Elliott: Probabilistic Number Theory II
241. Rudin: Function Theory in the Unit Ball of C^n
242. Huppert/Blackburn: Finite Groups II
243. Huppert/Blackburn: Finite Groups III
244. Kubert/Lang: Modular Units
245. Cornfeld/Fomin/Sinai: Ergodic Theory
246. Naimark/Stern: Theory of Group Representations
247. Suzuki: Group Theory I
248. Suzuki: Group Theory II
249. Chung: Lectures from Markov Processes to Brownian Motion
250. Arnold: Geometrical Methods in the Theory of Ordinary Differential Equations
251. Chow/Hale: Methods of Bifurcation Theory
252. Aubin: Nonlinear Analysis on Manifolds. Monge-Ampère Equations
253. Dwork: Lectures on p -adic Differential Equations
254. Freitag: Siegel'sche Modulfunktionen
255. Lang: Complex Multiplication
256. Hörmander: The Analysis of Linear Partial Differential Operators I
257. Hörmander: The Analysis of Linear Partial Differential Operators II
258. Smoller: Shock Waves and Reaction-Diffusion Equations
259. Duren: Univalent Functions
260. Freidlin/Wentzell: Random Perturbations of Dynamical Systems
261. Bosch/Güntzer/Remmert: Non Archimedean Analysis – A System Approach to Rigid Analytic Geometry
262. Doob: Classical Potential Theory and Its Probabilistic Counterpart

263. Krasnosel'skii/Zabreiko: Geometrical Methods of Nonlinear Analysis
264. Aubin/Cellina: Differential Inclusions
265. Grauert/Remmert: Coherent Analytic Sheaves
266. de Rham: Differentiable Manifolds
267. Arbarello/Cornalba/Griffiths/Harris: Geometry of Algebraic Curves, Vol. I
268. Arbarello/Cornalba/Griffiths/Harris: Geometry of Algebraic Curves, Vol. II
269. Schapira: Microdifferential Systems in the Complex Domain
270. Scharlau: Quadratic and Hermitian Forms
271. Ellis: Entropy, Large Deviations, and Statistical Mechanics
272. Elliott: Arithmetic Functions and Integer Products
273. Nikol'skii: Treatise on the Shift Operator
274. Hörmander: The Analysis of Linear Partial Differential Operators III
275. Hörmander: The Analysis of Linear Partial Differential Operators IV
276. Liggett: Interacting Particle Systems
277. Fulton/Lang: Riemann-Roch Algebra
278. Barr/Wells: Toposes, Triples and Theories
279. Bishop/Bridges: Constructive Analysis
280. Neukirch: Class Field Theory
281. Chandrasekharan: Elliptic Functions
282. Lelong/Gruman: Entire Functions of Several Complex Variables
283. Kodaira: Complex Manifolds and Deformation of Complex Structures
284. Finn: Equilibrium Capillary Surfaces
285. Burago/Zalgaller: Geometric Inequalities
286. Andrianaov: Quadratic Forms and Hecke Operators
287. Maskit: Kleinian Groups
288. Jacod/Shiryaev: Limit Theorems for Stochastic Processes
289. Manin: Gauge Field Theory and Complex Geometry
290. Conway/Sloane: Sphere Packings, Lattices and Groups
291. Hahn/O'Meara: The Classical Groups and K-Theory
292. Kashiwara/Schapira: Sheaves on Manifolds
293. Revuz/Yor: Continuous Martingales and Brownian Motion
294. Knus: Quadratic and Hermitian Forms over Rings
295. Dierkes/Hildebrandt/Küster/Wohlrab: Minimal Surfaces I
296. Dierkes/Hildebrandt/Küster/Wohlrab: Minimal Surfaces II
297. Pastur/Figotin: Spectra of Random and Almost-Periodic Operators
298. Berline/Getzler/Vergne: Heat Kernels and Dirac Operators
299. Pommerenke: Boundary Behaviour of Conformal Maps
300. Orlik/Terao: Arrangements of Hyperplanes
301. Loday: Cyclic Homology
302. Lange/Birkenhake: Complex Abelian Varieties
303. DeVore/Lorentz: Constructive Approximation
304. Lorentz/v. Golitschek/Makovoz: Constructive Approximation. Advanced Problems
305. Hiriart-Urruty/Lemaréchal: Convex Analysis and Minimization Algorithms I. Fundamentals
306. Hiriart-Urruty/Lemaréchal: Convex Analysis and Minimization Algorithms II. Advanced Theory and Bundle Methods
307. Schwarz: Quantum Field Theory and Topology
308. Schwarz: Topology for Physicists
309. Adem/Milgram: Cohomology of Finite Groups
310. Giaquinta/Hildebrandt: Calculus of Variations I: The Lagrangian Formalism
311. Giaquinta/Hildebrandt: Calculus of Variations II: The Hamiltonian Formalism
312. Chung/Zhao: From Brownian Motion to Schrödinger's Equation
313. Malliavin: Stochastic Analysis
314. Adams/Hedberg: Function Spaces and Potential Theory
315. Bürgisser/Clausen/Shokrollahi: Algebraic Complexity Theory
316. Saff/Totik: Logarithmic Potentials with External Fields
317. Rockafellar/Wets: Variational Analysis
318. Kobayashi: Hyperbolic Complex Spaces